

Automotive Connectors
【For board-to-FPC】

CF1

Product Catalog

**IN Your
Future**

CF1

For Automotive Application with 125°C heat resistance, Connectors for board-to-FPC

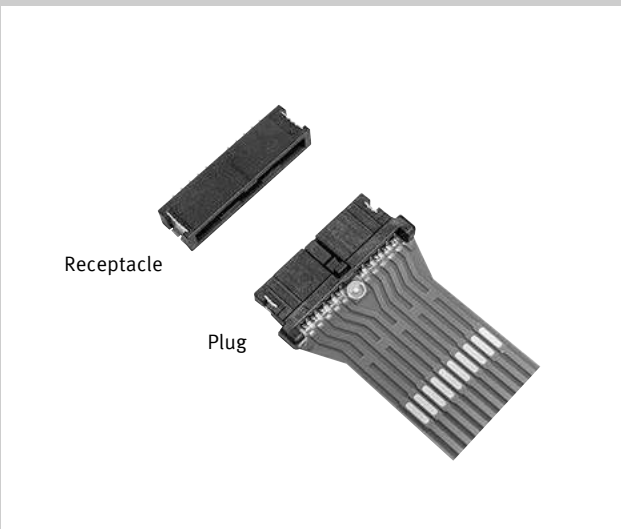

Receptacle

Plug

FEATURES

- Suitable for automotive applications that require vibration and heat resistance (125°C) characteristics.
- “Anti-misoperation bridge structure” prevents unintended operation of mating lock.
- FPCs and boards can be directly connected without relay wiring harnesses
- Contact reliability is preserved by double-sided contact structure
- Inertia lock construction prevents half-mating (4 pins only)

APPLICATIONS

- Connection of board and FPC in DRL/rear lamp
- Connection of board and FPC in BMS

DETAILED FEATURES

■ Mating condition

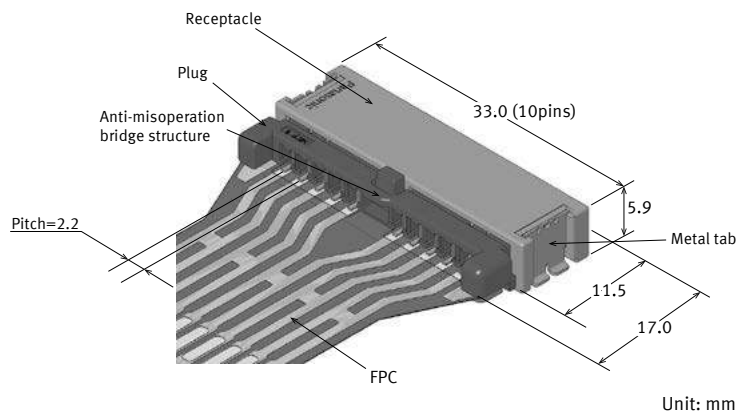

■ Plug SMD mounting

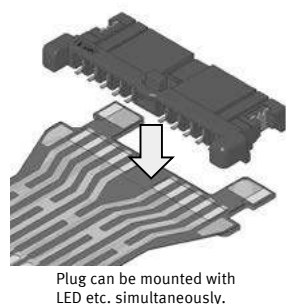

■ Metal terminal contact

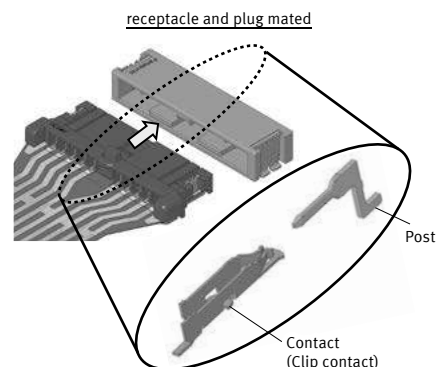

Principal use

■ Connection of board and FPC in DRL/rear lamp

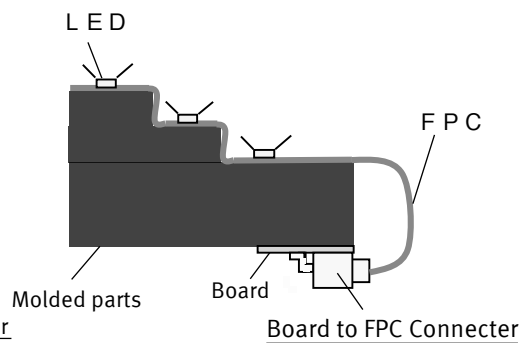
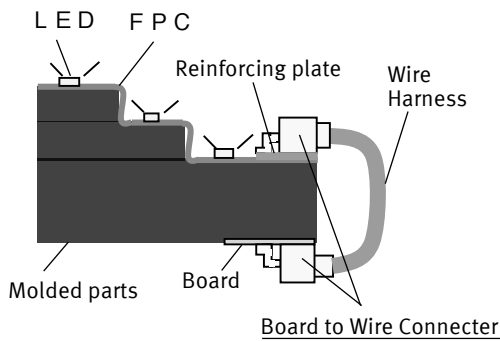
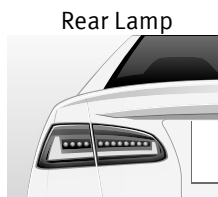
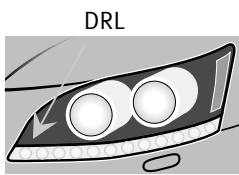

■ Connection of board and FPC in BMS (Battery Management System)

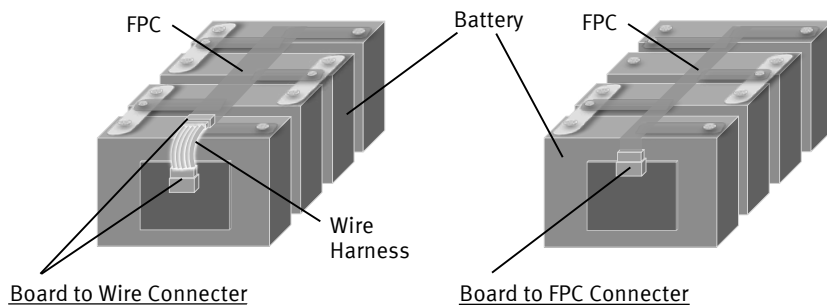

<< Elimination of relay wiring harness connectors by using CF1 >>

Receptacle

ORDERING INFORMATION

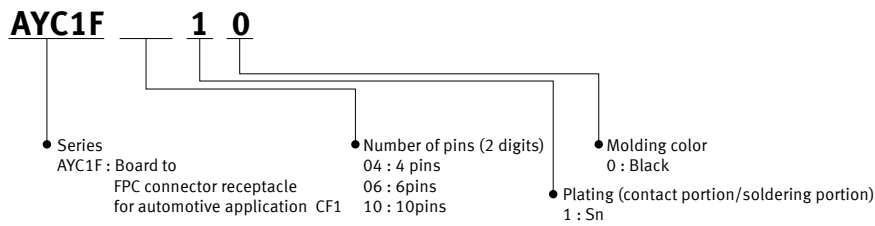

PRODUCT TYPES

Number of pins	Part No.	Packing	
		Inner carton (1-reel)	Outer carton
4 pins	AYC1F0410	800 pieces	1,600 pieces
6 pins	AYC1F0610	800 pieces	1,600 pieces
10 pins	AYC1F1010	800 pieces	1,600 pieces

Note: Order unit: For volume production: 1-inner carton (1-reel) units. For samples, please contact our sales representative.

Plug

ORDERING INFORMATION

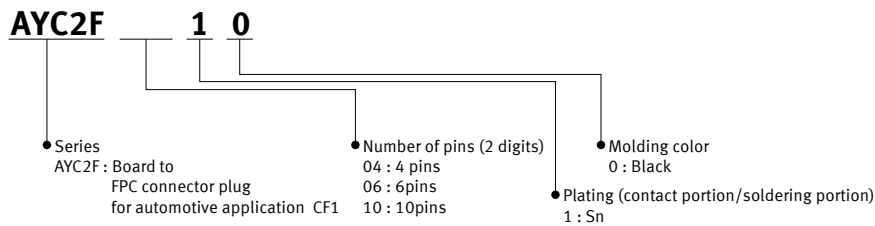

PRODUCT TYPES

Number of pins	Part No.	Packing	
		Inner carton (1-reel)	Outer carton
4 pins	AYC2F0410	800 pieces	1,600 pieces
6 pins	AYC2F0610	800 pieces	1,600 pieces
10 pins	AYC2F1010	800 pieces	1,600 pieces

Note: Order unit: For volume production: 1-inner carton (1-reel) units. For samples, please contact our sales representative.

SPECIFICATIONS

Characteristics

Item	Specifications	Conditions																			
Electrical characteristics	Rated current	2.0 A/pin contact	Maximum current can be applied to one contact. (Except for the capacity of FPC.)																		
	Rated voltage	50 V DC																			
	Dielectric strength	1,000 V AC for 1 min	Detection current: 1 mA (No short or damage)																		
	Insulation resistance	Min. 100 MΩ	Using 500 V DC megger (1 min)																		
	Contact resistance	Max. 20 mΩ (Initial) Max. 40 mΩ (after test)	Except FPC conductor resistance. Measured at 10 mA DC																		
Mechanical characteristics	Insertion force	Max. 36.0 N (Initial stage · No difference by number of pins.)																			
	Removal force	Max. 18.0 N (Initial stage · 4 pins) Max. 23.0 N (Initial stage · 6 pins) Max. 33.0 N (Initial stage · 10 pins)	Measured by removal of housing lock.																		
	Housing lock force	Min. 50.0 N (Initial stage · No difference by number of pins.)																			
Environmental characteristics	Temperature and humidity of ambient storage and transportation	-40 to +125 °C (Including temperature rise when applying current) (Storage and transportation temperature is -40 to +50 °C in a packing state.)* ¹	No icing or condensation																		
	Soldering heat resistance	The initial specification must be satisfied electrically and mechanically	Max. peak temperature of 260°C Reflow soldering: Max. 2 times (Temperature at connector terminal portion)																		
	Thermal shock resistance (Receptacle and plug mated)	After 500 cycles Contact resistance: Max. 40 mΩ	<table border="1"> <thead> <tr> <th>Order</th> <th>Temperature (°C)</th> <th>Time (minutes)</th> </tr> </thead> <tbody> <tr> <td>1</td> <td>-40₋₃⁰</td> <td>30</td> </tr> <tr> <td>2</td> <td>∕</td> <td>Max. 5</td> </tr> <tr> <td>3</td> <td>125₀⁺³</td> <td>30</td> </tr> <tr> <td>4</td> <td>∕</td> <td>Max. 5</td> </tr> <tr> <td></td> <td>-40₋₃⁰</td> <td></td> </tr> </tbody> </table> *Vapor phase	Order	Temperature (°C)	Time (minutes)	1	-40 ₋₃ ⁰	30	2	∕	Max. 5	3	125 ₀ ⁺³	30	4	∕	Max. 5		-40 ₋₃ ⁰	
	Order	Temperature (°C)	Time (minutes)																		
	1	-40 ₋₃ ⁰	30																		
	2	∕	Max. 5																		
	3	125 ₀ ⁺³	30																		
4	∕	Max. 5																			
	-40 ₋₃ ⁰																				
Humidity resistance (Receptacle and plug mated)	After 96 hours Contact resistance: Max. 40 mΩ Insulation resistance: Min. 100 MΩ	Bath temperature 60 ±2 °C Humidity 90 %RH																			
Heat resistance (Receptacle and plug mated)	After 120 hours Contact resistance: Max. 40 mΩ	Bath temperature 125 ±2 °C																			
Vibration resistance (Receptacle and plug mated)	Current shut off should not exceed 1μs during vibration test. (Contact resistance: Max. 40 mΩ)	Acceleration: 44 m/s ² Frequency: 20 to 200 Hz Sweep time: 3 min/cycle Testing tool: Refer to Fig.1* ² Direction: 3 axes (X,Y,Z) (Different samples are used for each direction.) Time: 3 h Detection current: 10 mA																			
Shock resistance (Receptacle and plug mated)	Current shut off should not exceed 1μs during shock test.	Acceleration: 981 m/s ² Operation time: 6 ms Testing tool: Refer to Fig.1* ² Direction: 6 direction (±X, ±Y, ±Z) (Different samples are used for each direction.) Number: 3 times Detection current: 10 mA																			
Lifetime characteristics	Insertion and removal life	10 times (Contact resistance: Max. 40 mΩ)	Speed: 25 mm/min																		
Solder paste thickness	The initial specification must be satisfied electrically and mechanically		Recommendation t=0.15 mm																		

*1. As the humidity range differs depending on the ambient temperature, the humidity range indicated below should be used.
This temperature and humidity range does not guarantee permanent performance.

*2. Fig.1

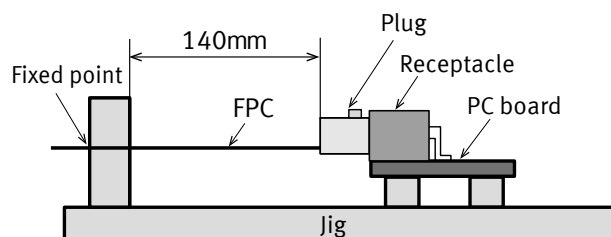
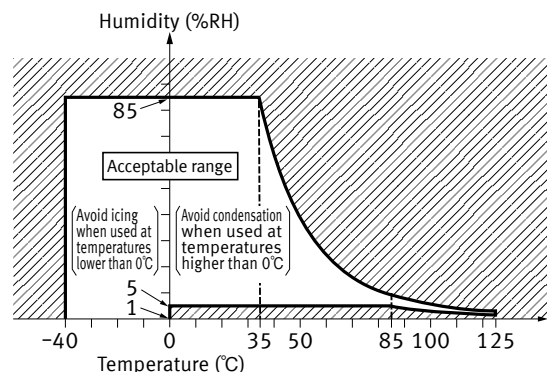

Automotive Connectors CF1

Material and surface treatment

● Receptacle

Part name	Material	Color	Surface treatment
Body	LCP resin (UL94V-0)	Black	—
Post	Copper alloy	—	Contact portion: Sn plating over nickel Soldering portion: Sn plating over nickel
Metal tab	Copper alloy	—	Soldering portion: Sn plating over nickel

● Plug

Part name	Material	Color	Surface treatment
Housing	LCP resin (UL94V-0)	Black	—
Contact	Copper alloy	—	Contact portion: Sn plating over nickel Soldering portion: Sn plating over nickel
Metal tab	Copper alloy	—	Soldering portion: Sn plating over nickel

DIMENSIONS

CAD The CAD data of the products with a "CAD" mark can be downloaded from our Website..

(Unit: mm)

■ Receptacle

● 4 pins

CAD

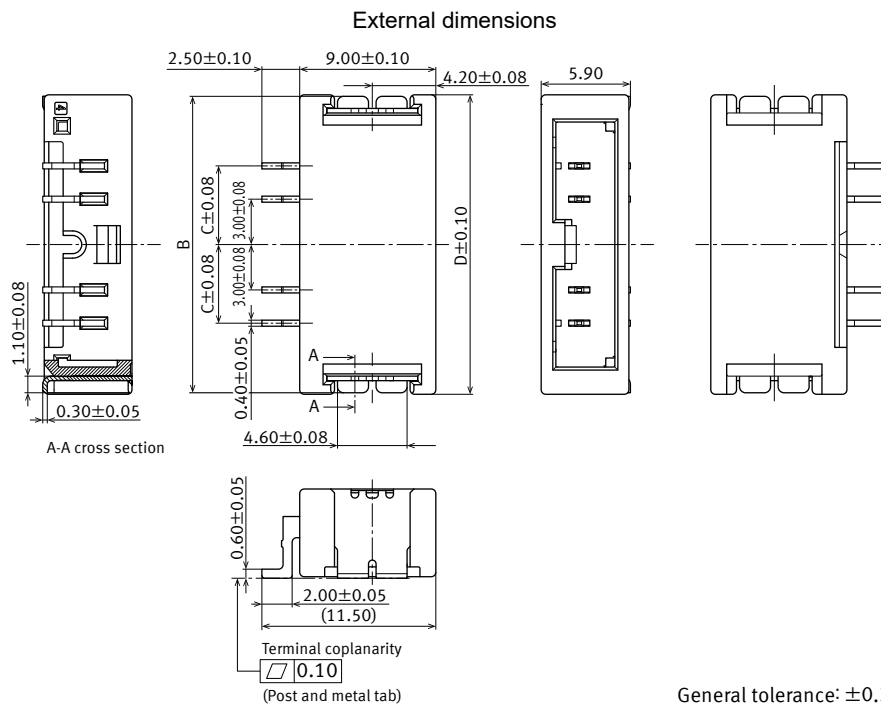
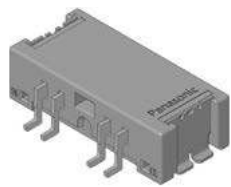

Dimension table

Dimensions	B	C	D
Number of pins			
4	19.60	5.20	19.80

Automotive Connectors CF1

● 6 pins, 10 pins

CAD

External dimensions

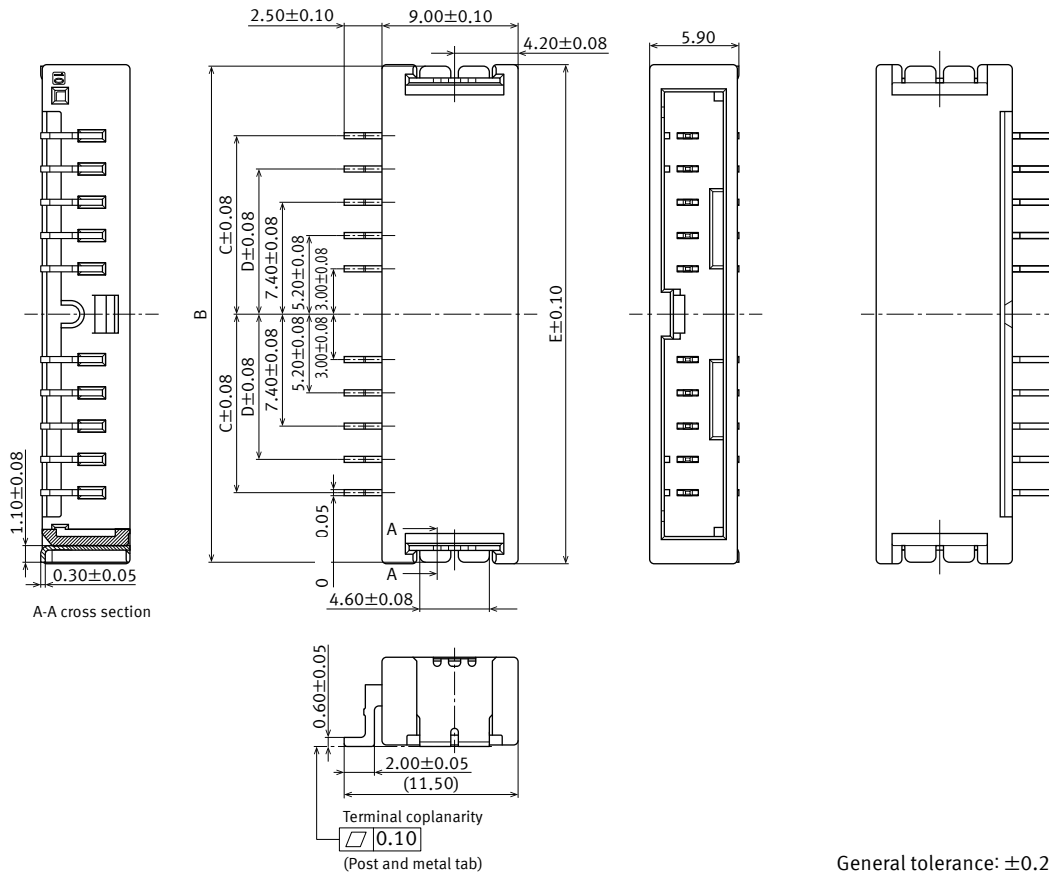

Dimension table

Dimensions Number of pins	B	C	D	E
6	24.00	—	—	24.20
10	32.80	11.80	9.60	33.00

Automotive Connectors CF1

- Plug
- 4 pins
- CAD**



External dimensions

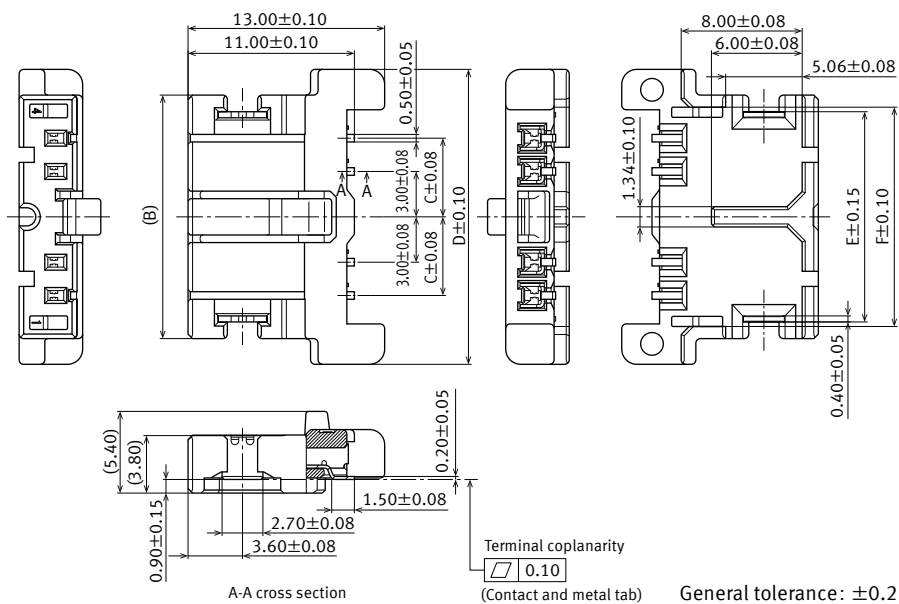

Dimension table

Dimensions / Number of pins	B	C	D	E	F
4	16.10	5.20	19.50	13.90	14.50

- 6 pins, 10 pins

CAD

External dimensions

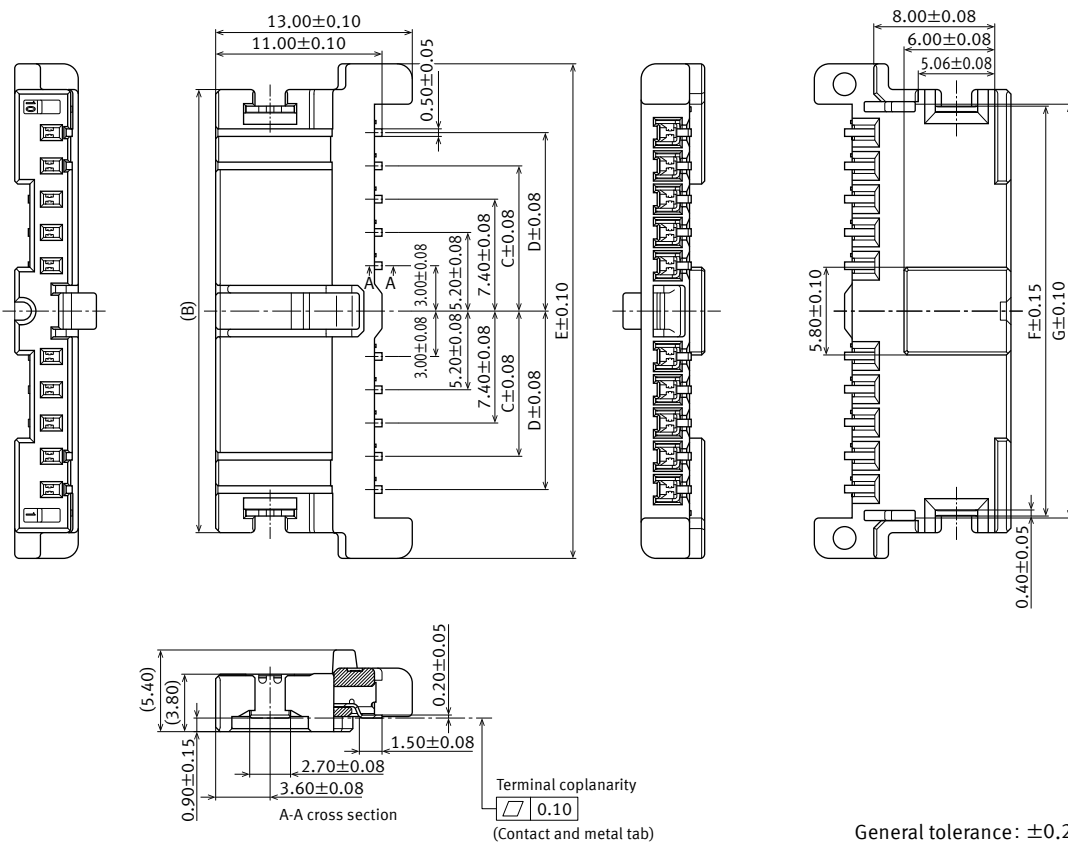

Dimension table

Dimensions / Number of pins	B	C	D	E	F	G
6	2.50	—	—	23.90	18.30	18.90
10	29.30	9.60	11.80	32.70	27.10	27.70

■ Mating condition

CAD

External dimensions

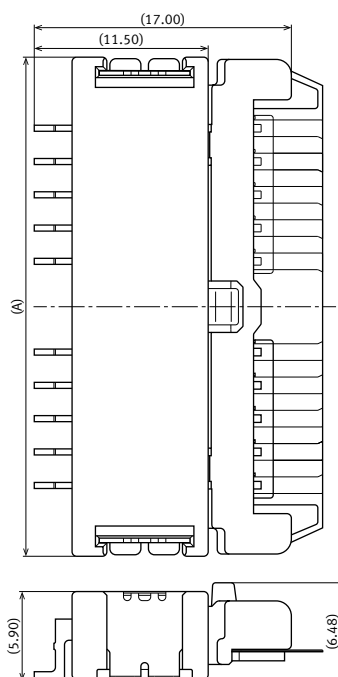

Dimension table

Number of pins	Dimensions	A
4		19.80
6		24.20
10		33.00

PACKAGING SPECIFICATIONS

Unit: mm

■ Receptacle

● Specifications for taping

In accordance with JIS C 0806-3:1999.

However, does not apply to distance between center of round feed hole and center of embossed part.

*Part dimension: Distance between center of round feed hole and center of recommended suction area.

● Specifications for the plastic reel

In accordance with EIAJ ET-7200B.

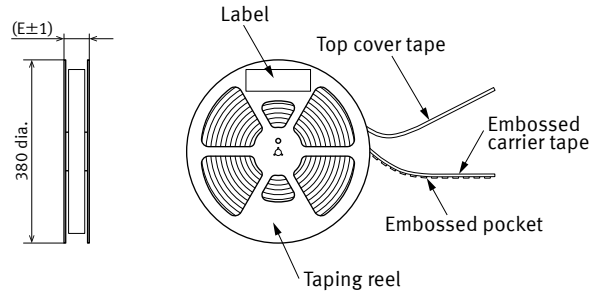
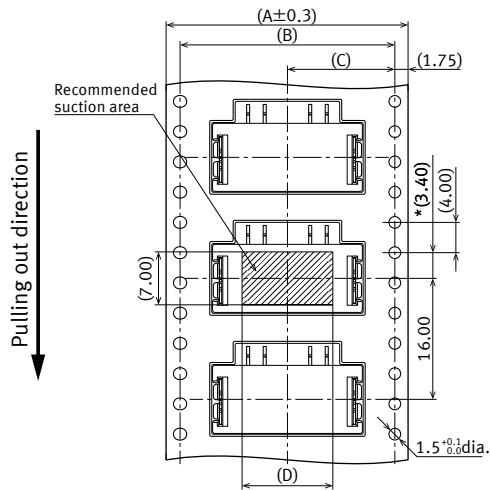

● Dimension table

Number of pins	A	B	C	D	E
4	32.0	28.4	14.2	12.0	33.4
6	44.0	40.4	20.2	16.4	45.4
10	56.0	52.4	26.2	25.2	57.4

● Receptacle orientation with respect to embossed tape feeding direction

Direction of tape progress	Type	Receptacle
↓		

Automotive Connectors CF1

■ Plug

● Specifications for taping

In accordance with JIS C 0806-3:1999.

However, does not apply to distance between center of round feed hole and center of embossed part.

*Part dimension: Distance between center of round feed hole and center of recommended suction area.

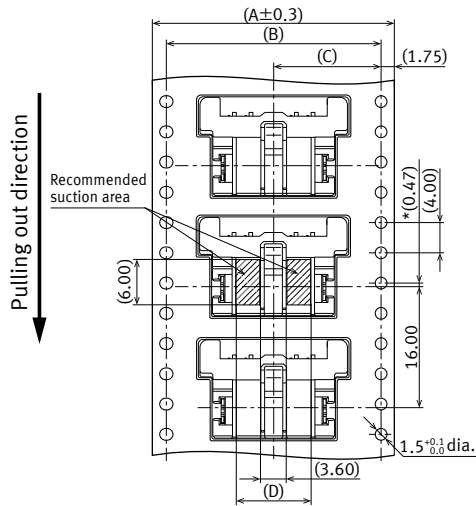

● Specifications for the plastic reel

In accordance with EIAJ ET-7200B.

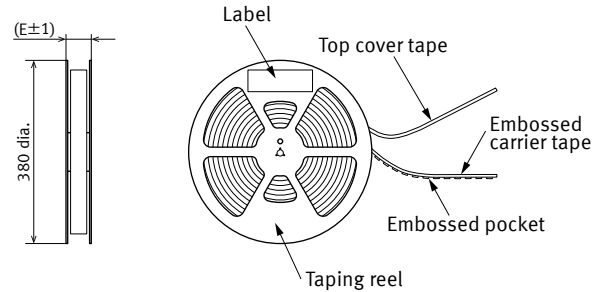

● Dimension table

Number of pins	A	B	C	D	E
4	32.0	28.4	14.2	9.90	33.4
6	44.0	40.4	20.2	14.3	45.4
10	56.0	52.4	26.2	18.7	57.4

● Plug orientation with respect to embossed tape feeding direction

Direction of tape progress	Type	Plug
↓		

Notes on Using Connectors for Automotive Application

PRECAUTION FOR USE

Unit: mm

■ Design of PC board and FPC board

Conduct the recommended foot pattern design, in order to preserve the mechanical strength of soldering portion.

■ Recommended PC board and FPC board patterns

In order to reduce solder and flux rise, solder bridges and other issues make sure the proper levels of solder is used. The figures are recommended patterns. Please use them as a reference.

■ Receptacle

● Recommended PC board pattern

(Mounting layout, TOP VIEW)

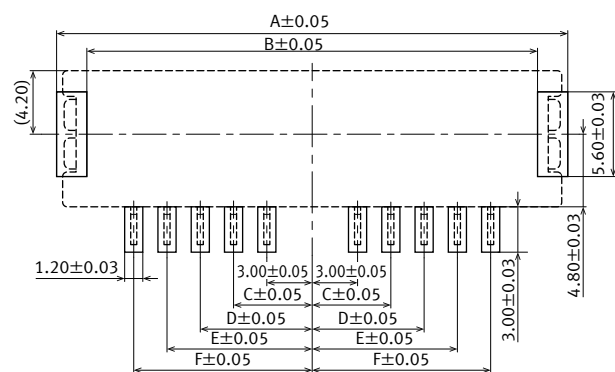

● Recommended metal mask pattern

Metal mask thickness: When 150 μm

(Post portion opening area ratio: 100 %)

(Metal tab portion opening area ratio: 100 %)

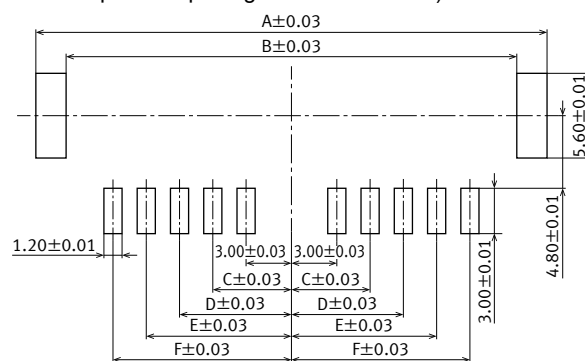

● Dimension table

Dimensions	A	B	C	D	E	F
Number of pins						
4	20.60	16.60	5.20	—	—	—
6	25.00	21.00	5.20	7.40	—	—
10	33.80	29.80	5.20	7.40	9.60	11.80

Automotive Connectors CF1

■ Plug

● Recommended FPC board pattern

- Copper foil pattern (and outer shape of FPC)

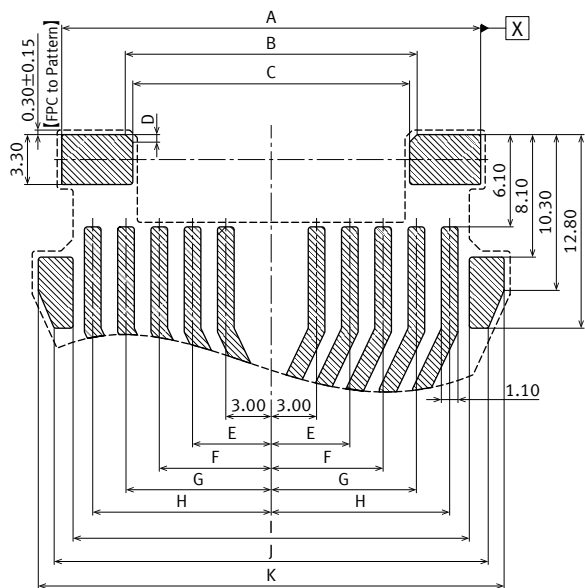

General tolerance: ± 0.1

Note 1) : Pad area (Copper foil)

2) : Cover film area

3) Unspecified corner : R 0.20

4) Dimension " * " is common to both FPC and Cover film.

5) Pad area is rust proofing.

● Dimension table

Dimensions	A	B	C	D	E	F	G	H	I	J	K
Number of pins											
4	14.50	6.30	3.20	1.55	5.20	—	—	—	13.00	15.50	17.60
6	18.90	10.50	9.50	0.50	5.20	7.40	—	—	17.40	19.90	22.00
10	27.70	19.30	18.30	0.50	5.20	7.40	9.60	11.80	26.20	28.70	30.80

- Diagram of outer shape of FPC and Cover film attachment [(1)]

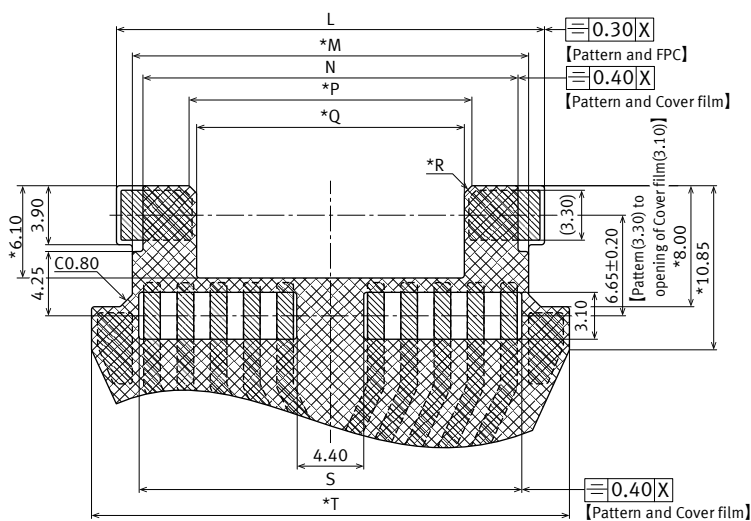

General tolerance: ± 0.1

● Dimension table

Dimensions	L	M	N	P	Q	R	S	T
Number of pins								
4	15.10	13.00	11.60	5.40	2.50	C1.45	12.10	18.40
6	19.50	17.40	16.00	9.90	8.90	C0.50	16.50	22.80
10	28.30	26.20	24.80	18.70	17.70	C0.50	25.30	31.60

Automotive Connectors CF1

- Diagram of reinforcing plate [(2)]

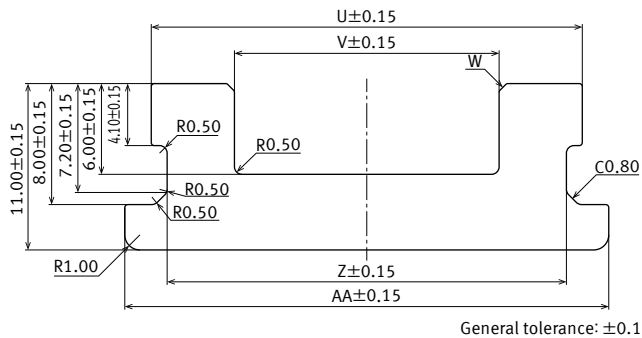

● Dimension table

Number of pins	Dimensions				
	U	V	W	Z	AA
4	15.30	2.30	C1.00	13.20	18.80
6	19.70	8.70	C0.50	17.60	23.20
10	28.50	17.50	C0.50	26.40	32.00

- Diagram of reinforcing plate attachment (when completed) [(1)+(2)]

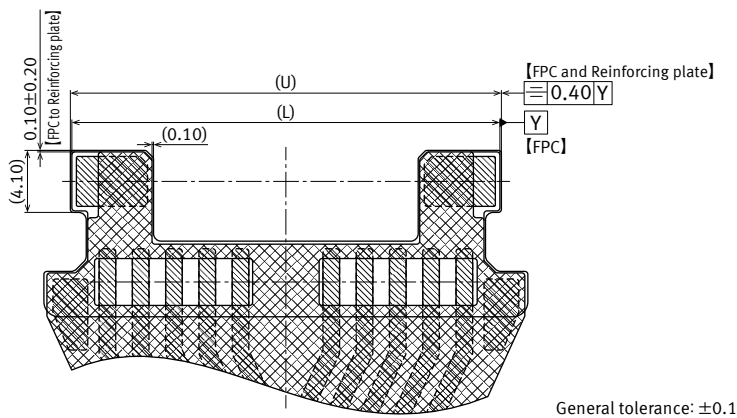

● Dimension table

Number of pins	Dimensions	
	U	L
4	15.30	15.10
6	19.70	19.50
10	28.50	28.30

- Layer composition

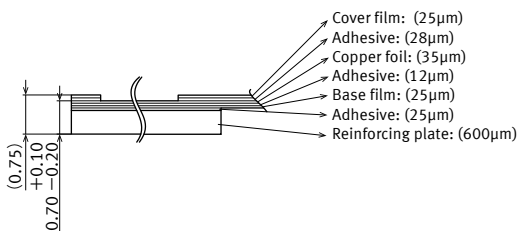

- Recommended metal mask pattern
 Metal mask thickness : When 150µm
 (Contact portion opening area ratio : 100%)
 (Metal tab portion opening area ratio : 70%)

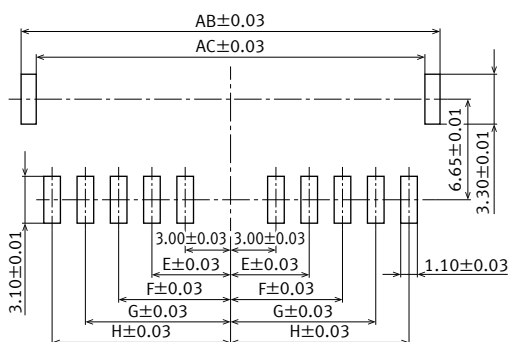

● Dimension table

Number of pins	Dimensions					
	E	F	G	H	AB	AC
4	5.20	—	—	—	14.50	12.50
6	5.20	7.40	—	—	18.90	16.90
10	5.20	7.40	9.60	11.80	27.70	25.70

ABOUT SAFETY REMARKS

Observe the following safety precautions to prevent accidents and injuries.

- Do not use these connectors beyond the specification sheets. The usage outside of specified rated current, dielectric strength, and environmental conditions and so on may cause circuitry damage via abnormal heating, smoke, and fire.
- In order to avoid accidents, your thorough specification review is appreciated. Please contact us if your usage is out of the specifications. Otherwise, Panasonic Industry Co., Ltd. cannot guarantee the quality and reliability.

- Panasonic Industry Co., Ltd. is consistently striving to improve quality and reliability. However, the fact remains that electrical components and devices generally cause failures at a given statistical probability. Furthermore, their durability varies with use environments or use conditions. In this respect, please check for actual automobile under actual conditions before use. Continued usage in a state of degraded condition may cause the deteriorated insulation, thus result in abnormal heat, smoke or firing. Please carry out safety design and periodic maintenance including redundancy design, design for fire spread prevention, and design for malfunction prevention so that no accidents resulting in injury or death, fire accidents, or social damage will be caused as a result of failure of the Products or ending life of the Products.

Mounting

1) Regarding PC board and FPC board design

- Refer to the recommended PC board and FPC board pattern for keeping the strength of soldering.

2) Connector placement

- In case of dry condition, please note the occurrence of static electricity. The product may be adhered to the embossed carrier tape or the cover tape in dry condition. Recommended humidity is from 40 % RH to 60 % RH and please remove static electricity by ionizer in manufacturing process.

3) Soldering

(1) Reflow soldering

- When cream solder printing is used, screen method is recommended.
- The relation between the screen opening area and foot pattern area should be referred to "Recommended metal mask and PC board pattern" drawings and "Recommended metal mask and FPC board pattern" drawings.
- If it is used with a thickness different from the recommended metal mask thickness, it may not be mounted, or the mounting strength may decrease. Please be careful to metal mask thickness.

- Please be careful to align terminals and solder pads, because this product does not have self-alignment features.
- The following diagram shows the recommended reflow soldering temperature profile.

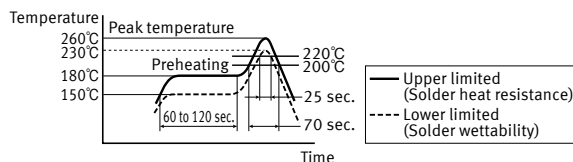

- Infrared reflow soldering is able to passed two times.
- The temperature is measured at the connector terminals.
- The condition of solder or flux creepage and wettability depend on the type of solder and flux. Please set the reflow temperature and oxygen level by considering the solder and flux characteristics.

(2) Manual soldering.

- Please avoid the excessive solder. Because the excessive solder makes creepage at contact portion.
- Please use the soldering iron under specified temperature and times.
- As excessive force to terminal by manual soldering has some possibilities of terminal portion deformation, please be careful to the force by hand.
- Please clean soldering iron tip.

(3) Rework of soldering portion.

- Rework shall be only one time.
- Please avoid the supplementary flux in case of rework for soldering bridge, as this may cause flux creepage to contact portion.
- Please use the soldering iron under specified temperature.

4) As the excessive force on the terminals may cause the deformation and the integrity of solderability will be lost during reflow soldering, please avoid dropping or rough handling of the product.

5) When the soldering is not completed, do not mate nor unmate the connectors. And the external compulsory force to the terminal may cause the fixing force lowering between the terminal and the molding or the coplanarity failures.

6) When cutting the PC board after mounting the receptacle, please avoid the stress at the soldering portion.

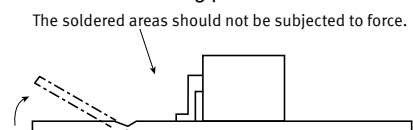

7) Cleaning treatment

- Cleaning this product is not needed basically. Please note the following points to prevent the negative effect to the product when cleaning is necessary.
- Please keep the cleanliness of the cleaning fluid to make sure that the contact surfaces are not contaminated by the cleaning fluid itself.
- Semi-aqueous cleaning solvent is recommended as some powerful solvent may dissolve the molding portion or the marked letters. Please contact us when other solvent is used.

Insertion, removal and retention of mating

- This product is designed with ease of handling. However, in order to prevent the deformation or damage of contacts and molding, do not mate the connectors such as the following
Insertion or removal while prying from right to left or up and down.
Insertion of upside-down state.
- Inserting the plug with excessive force may break the products.
Please be careful as excessive force is not applied.
- This product has lock structure for mating. However, the lock may be broken depending on reaction force due to FPC routing. Please confirm sufficiently at usage.
- When remove the connector, please hold the housing while pushing the latch-lock. Pulling the FPC only, will cause the product is damaged.
- Please avoid wiring, such as continue to apply stress to the base of the FPC. It may cause breaking of the FPC or failure of the products.

Precautions for operating environment and storage environment

- Panasonic Industry Co., Ltd. does not guarantee the failures caused by condensation.
- Please use our products within six months from the date of products acceptance.
Please confirm solderability, when using after the recommended storage period.

Other precautions

- When the coating material is used for preventing board isolation deterioration after soldering, please assure the coating material is not adhered on any part of connector.
- Please avoid the usage of connector as electric switching basically.
- Please care to the FPC pattern design such as the width and thickness, because the FPC has risk for excessive temperature rise due to factors on the FPC side.

Please refer to **"the latest product specifications"** when designing your product.

•Requests to customers:

<https://industrial.panasonic.com/ac/e/salespolicies/>

Panasonic
INDUSTRY

Panasonic Industry Co., Ltd.

Electromechanical Control Business Division
■1006, Oaza Kadoma, Kadoma-shi, Osaka 571-8506, Japan
industrial.panasonic.com/ac/e/