



SPECIFICATION SHEET

SPECIFICATION SHEET NO.	N0511- MSA75681M0S001
DATE	May 11, 2021
REVISION	A0
DESCRIPTION	SMD Power Inductor, MSA series Inductance (L) 680μH, Tolerance 20% Operating Temp. Range -55°C ~+125°C, Package in Tape/Reel, 1000pcs/Reel RoHS/RoHS III compliant
CUSTOMER	
CUSTOMER PART NUMBER	
CROSS REF. PART NUMBER	
ORIGINAL PART NUMBER	MSA75-681M
PART CODE	MSA75681M0S001

VENDOR APPROVE			
Issued/Checked/Approved			
DATE: May 11, 2021			

CUSTOMER APPROVE	
DATE:	

SMD POWER INDUCTORS MSA SERIES

MAIN FEATURE

- RoHS Compliant
- Super Low Resistance, Ultra High Current Rating
- High Performance (Isat) Realized by metal dust core
- Frequency Range : up to 1.0MHz

APPLICATION

- Low Profile and High current power Supplies
- Battery power device
- DC/DC converters in distributed power system
- DC/DC converters for Field programmable gate array



RFQ
Request For Quotation

PART CODE GUIDE

MSA75	681M0	S	001
1	2	3	4

- 1) **MSA75**: Series code for SMD Power Inductor, MSA series, Dimension 7.8*7.0*5.0mm
- 2) **681M0**: Specification code: Inductance (L) 680μH, Tolerance 20%
- 3) **S**: Package code, Tape/reel, 1000pcs/reel.
- 4) **001**: Internal Control Code or special code required by customer- 3 letter or digits

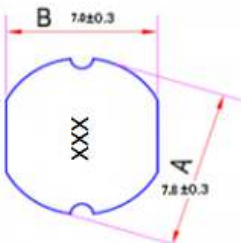
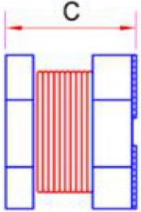
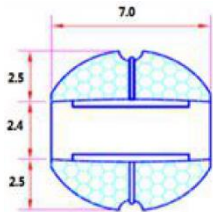
DIMENSION (Unit: mm)

Top View	Side View	Bottom View	Image for Ref.
			

Item	Dimension
A	7.8+/-0.3
B	7.0+/-0.3
C	5.0+/-0.3

SMD POWER INDUCTORS MSA SERIES

ELECTRONICAL CHARACTERISTICS

Parameter		Specification	Condition	Test Instruments
L (μH)	S-F	680+/-20%	1KHz/0.25V	MICROTEST 6377
DCR (Ω)	S-F	2.3 Max.	25 °C	TH16502
I sat (A)	S-F	0.25A Typical L0A*80%	1KHz/0.25V	MICROTEST 6377+6220

ELECTRICAL SCHEMATIC CIRCUIT

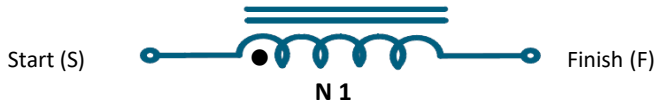

CHARACTERISTICS

- 1) All test data is based on 25 °C ambient.
- 2) DC current (A) that will cause an approximate $\Delta T 40$ °C
- 3) DC current (A) that will cause L0 to drop approximately 30% Typical.
- 4) Operating temperature range : -55°C~+125 °C
- 5) The part temperature(ambient + temp. rise) should not exceed 125 °C under worst case operating conditions. Circuit design, component. PWB trace size and thickness, airflow and other cooling provision all affect the part temperature. Part temperature should be verified in the den application

REFLOW SOLDERING PROFILE

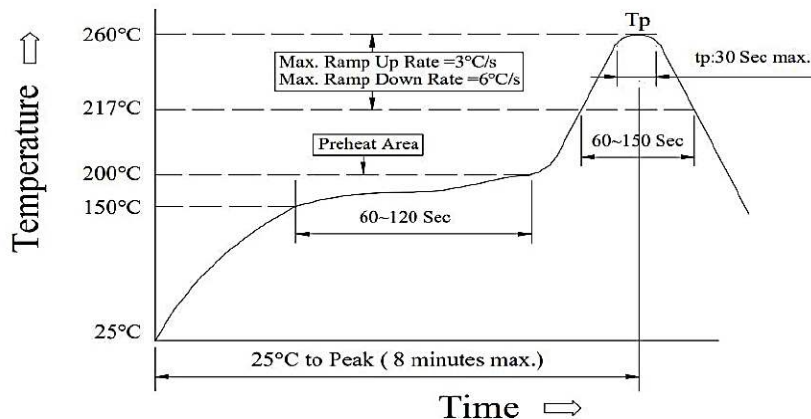

SMD POWER INDUCTORS MSA SERIES

REEL DIMENSION (Unit: mm, 1000pcs/Reel)

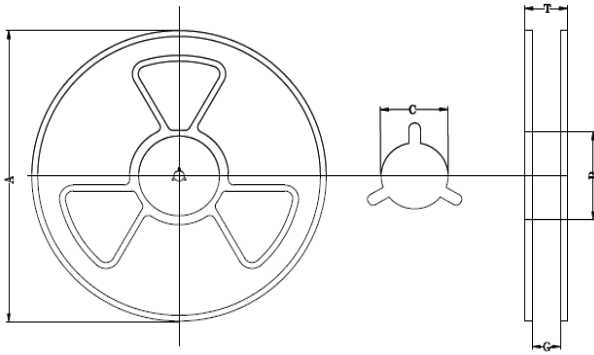

Code	Dimension
A	330.0+/-2.0
B	100.0+/-10
C	13.0+/-1.0
G	24.4+/-1.0
T	30.4 Max.

TAPE DIMENSION (UNIT: MM)

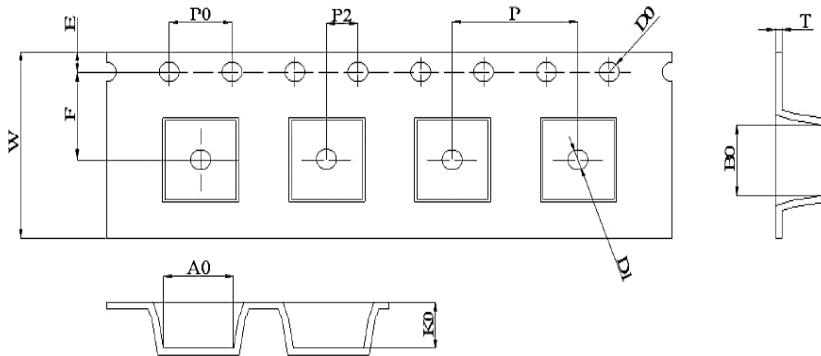

Code	Dimension
W	16.0+/-0.30
A0	7.2+/-0.10
B0	8.2+/-0.10
K0	5.3+/-0.1
P	12.0+/-0.1
F	7.5+/-0.1
E	1.75+/-0.1
D0	1.5+/-0.1
P0	4.0+/-0.1
T	0.35+/-0.05

SMD POWER INDUCTORS MSA SERIES
ENVIRONMENTAL TEST

Items	Required Characteristics	Test Method/Condition
High Temp. Storage Test Ref. Document: MIL-STD-202G Method 108A	<ol style="list-style-type: none"> No case deformation or change in appearance $\Delta L/L \leq 10\%$ or 15% $\Delta Q/Q \leq 30\%$ $\Delta DCR/DCR \leq 10\%$ 	Temperature: N+/-2 °C Time: 96+/-2 hours Test not less than 1 hour and no more than 2 h at 25 °C (See Table 1- Fig. 1)
Low Temp. Storage Test Ref. Document: IEC 68-2-1A 6.1 & 6.2	<ol style="list-style-type: none"> No case deformation or change in appearance $\Delta L/L \leq 10\%$ or 15% $\Delta Q/Q \leq 30\%$ $\Delta DCR \leq 10\%$ 	Temperature: M+/-2 °C Time: 96+/-2 hours Test not less than 1 h and no more than 2 hours at 25 °C (See Table 1- Fig. 2)
Humidity test Ref. Document: MIL-STD-202G Method 103A	<ol style="list-style-type: none"> No case deformation or change in appearance $\Delta L/L \leq 10\%$ or 15% $\Delta Q/Q \leq 30\%$ $\Delta DCR \leq 10\%$ 	Temperature: 40+/-2 °C Humidity: 93+/-3% RH Time: 96+/-2 Hours Test not less than 1 hour and no more than 2 hours at 25 °C
Thermal shock Test Ref. Document: MIL-STD-202G Method 107G	<ol style="list-style-type: none"> No case deformation or change in appearance $\Delta L/L \leq 10\%$ or 15% $\Delta Q/Q \leq 30\%$ $\Delta DCR \leq 10\%$ For T: Weight $\leq 28g$; 15 Min. M: low temp. $28g \leq \text{weight} \leq 136g$: 30 min N high temperature	First M for T time, last N °C time as 1 cycle. GO through 20 cycles. (See Table 1- Fig. 3)

PHYSICAL CHARACTERISTICS TEST

Items	Required Characteristics	Test Method/Condition
Solderability Test Ref. Documents MIL-STD-202G Method 208H IPC-J-STD-002C	Terminate area must have 95% Min.	<ol style="list-style-type: none"> Dip pads in flux then dip in solder at 260 +/-5 °C for 5 second Solder: Lead free Flux: rosin flux
Heat endurance of Reflow Soldering Ref. Documents IPC-J-STD-020D	<ol style="list-style-type: none"> No case deformation or change in appearance $\Delta L/L \leq 10\%$ or 15% $\Delta Q/Q \leq 30\%$ $\Delta DCR/DCR \leq 10\%$ 	<ol style="list-style-type: none"> Refer to the mentioned Reflow Curve and go through 3 times The peak temperature: 260 +/-5 °C
Vibration Test Ref. Documents MIL-STD-202G Method 201A	<ol style="list-style-type: none"> No case deformation or change in appearance $\Delta L/L \leq 10\%$ or 15% $\Delta Q/Q \leq 30\%$ $\Delta DCR/DCR \leq 10\%$ 	Apply frequency 10-55Hz 1.5mm amplitude in each of perpendicular direction X, Y Z for 2 hours (total: 6 hours) (See Table 1-Fig. 4)
Drop Test Ref. Documents MIL-STD-202G Method 203C	<ol style="list-style-type: none"> No case deformation or change in appearance $\Delta L/L \leq 10\%$ or 15% $\Delta Q/Q \leq 30\%$ $\Delta DCR/DCR \leq 10\%$ 	Packaged & Drop down from 1m with $981m/s^2$ (100G) attitude in 1 angle and 2 surfaces orientations
Terminal strength push Test Ref. Documents JIS C 5321:1997	Pulling test: Define A: sectional area of terminal $0.5mm^2 < A \leq 1.2mm^2$; Force $\geq 20N$ time: 10 sec. $1.2mm^2 < A$; force $\geq 20N$ time: 10 sec. Bending Test: Soldering the product on PCB, after the pulling test and bending test, terminal should not pull off.	Bend the testing PCB at middle point the deflection shall be 2mm (See Table 1-Fig. 5)
Resistance to Solvent Test Ref. Document IEC 68-2-45: 1993	No case deformation or change in appearance or obliteration of marking	To dip parts IPA solvent for 5+/-0.5 minute then drying them at room temperature for 5 minute, at last to brushing marking 10 times

SMD POWER INDUCTORS MSA SERIES

ELECTRICAL CHARACTERISTIC TEST

Items	Required Characteristics	Test Method/Condition
Electronic Characteristic test of major products	Refer to catalogue of specific products	Refer to catalogue of specific products
Overload Test Ref. Document: JIS C5311-6.13	<ol style="list-style-type: none"> During the test no smoke, no peculiar, smell, no fire The characteristic is normal after tested 	Apply twice rated current for 5 minutes (It's not application to some special design)
Voltage resistance test Ref. Document: MIL-STD-202G Method 301	<ol style="list-style-type: none"> During the test no breakdown The characteristic is normal after tested 	<ol style="list-style-type: none"> For parts with no coils DC 100V; Current: 1 mA, 1 minute

CURVE OF HEAT ENDURANCE OF REFLOW SOLDERING TEST



- This peak temperature only applicable to some specific parts. The operating parameter may be different according to the pay type.
- A test made under the conditions mentioned above and it is left 1 hour in the normal temperature.
- The reflow condition is according to the machine used by own company.
- The above specification are only for reference, follow confirmation documents for the specific test condition.

Table 1

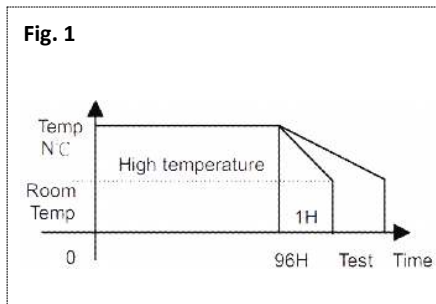
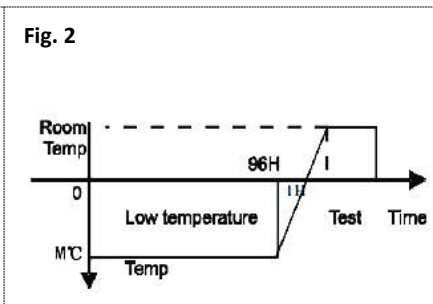
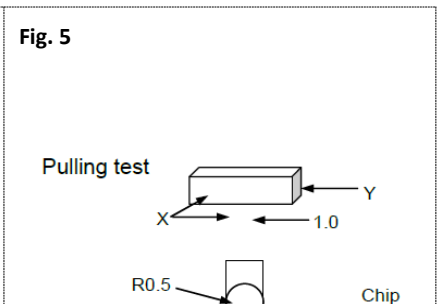
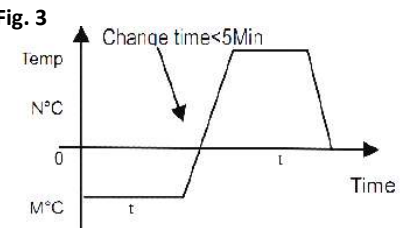
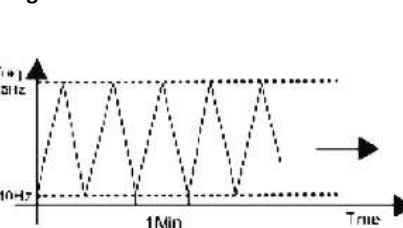
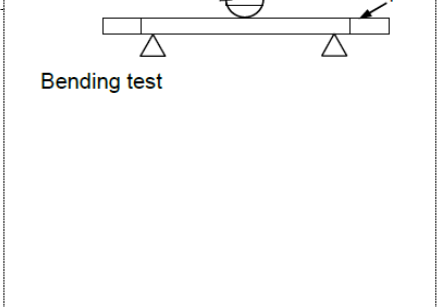
<p>Fig. 1</p> 	<p>Fig. 2</p> 	<p>Fig. 5</p> 
<p>Fig. 3</p> 	<p>Fig. 4</p> 	<p>Fig. 5</p> 

SMD POWER INDUCTORS MSA SERIES

Item	Application Notice
Storage Condition	To maintain the solderability of terminal electrodes <ol style="list-style-type: none"> 1. Temperature and humidity conditions: less than 30% and 60% RH. 2. Recommended ceramic chip inductors should be used within 6 month after delivery. 3. The package material should be kept where no chlorine or sulfur exists in the air.
Handling	<ol style="list-style-type: none"> 1. The use of tweezers or vacuum pick ups is strongly recommended for individual components. 2. Bulk handling should ensure that abrasion and mechanical shock are minimized. 3. Chip multilayer ceramic inductors should be handled with care to avoid damage or contamination from perspiration and skin oils.
Design of Land Pattern	<p>Component pads should be designed to achieve good solder fillets and minimize component movement during reflow soldering. Pads designs are given below for the most common sizes of multilayer ceramic inductors for both wave and reflow soldering. The basis of these designs are:</p> <ol style="list-style-type: none"> 1. Pad width equal to component width it is permissible to decrease this to as low 85% of components width but it is not advisable to go below this. 2. Pad overlap 0.5mm beneath component. 3. Pad extension 0.5mm beyond components for reflow and 1.0mm for wave soldering. 4. Example of good and band solder application.(see table 2) 5. Components space: For wave soldering component, must be spaced sufficiently far apart to avoid bridging or shadowing (inability of solder to penetrate properly into small space) and ensure space must be allowed to enable rework should it be required. (see table 2)
Preheat	<p>It is important to avoid possibility of thermal shock during soldering and carefully controlled preheat is therefore required. The rate of preheat should no exceed 4°C/sec. and a target figure 2°C/sec.is recommended. Although an 80°C to 120°C temperature differential is preferred, recent test result allow a temperature of 150°C Max. for components of 1.2*1.0mm size and below with a Max. thickness of 1.25mm. The users is cautioned that the risk thermal shock increases as chip size or temperature differential increases.</p>
Solderability	<p>Terminations to be well soldered after immersion in a Sn(96.5), Ag (3.5) tin/lead solder bath at 260+/-50°C for 5+/-1 seconds.</p>
Selection of Flux	<p>Since flus may have a signification effect on the performance of components, it is necessary to verify following conditions prior to use.</p> <ol style="list-style-type: none"> 1. Flux used should be with less than or equal to 0.1 wt% (equivalent to Chlorine) of halogenated content, Flux having a strong acidity content should not be applied. 2. When soldering component on the PCB, the amount of Flux applied should be controlled at optimum level 3. When using water should be flux, special care should be taken to properly clean the PCB.
Soldering	<p>Mildly activated rosin fluxes are preferred. The minimum amount of solder for give a good joint should be used excessive solder can lead to damage from the stresses caused by the difference in coefficients of expansion between solder, ship and substrate, 3L terminations are suitable for all wave and reflow soldering system. If hand soldering can't be avoided, the preferred technique is the utilization of hot air soldering tool. (see table 3)</p> <ol style="list-style-type: none"> 1. Solder Reflow: Recommended temperature profile. 2. Solder Wave: Wave soldering is perhaps the most rigorous of SMT soldering processes due to the steep rise in temperature seen by the circuit when immersed in the molten solder wave typically at 240°C. Wave soldering of ceramic chip inductors larger then 1.8*1.2mm size is discouraged due to the risk of thermal damage to the inductors Recommended temperature profile. 3. Soldering Iron: <ol style="list-style-type: none"> (1) Preheat circuit and inductor to 150°C. (2) Never contact the ceramic with the iron tip (3) Use a 20 watt soldering iron with tip diameter of 1.0mm. (4) 280 °C tip temperature Max. (5) 1.0mm tip temperature Max. (6) Limited soldering time is less than 3 seconds

SMD POWER INDUCTORS MSA SERIES

Table 2

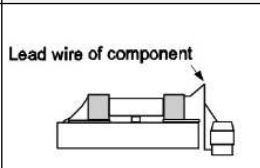
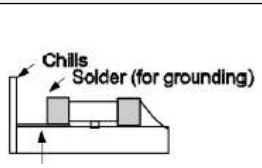
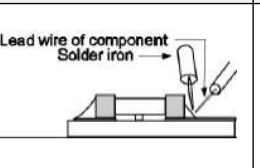
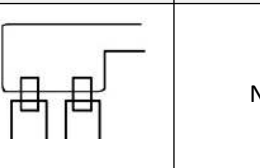
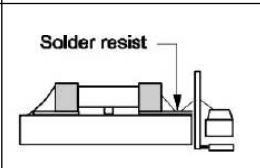
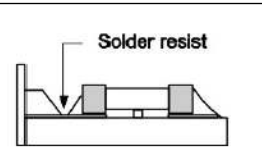
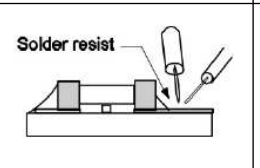
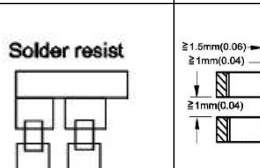
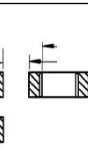
Item	Mixed mounting of SMD and leaded inductors	Inductors placement close to the chassis	Hand-soldering of leaded inductors near mounted components	Horizontal Inductors placement	Inductors space
Bad					N/A
Good					

Table 3

Recommended Temperature Profile for Reflow Soldering	Recommended Temperature Profile for Wave Soldering	Recommended Temperature Profile for Hand Soldering
