

Product Datasheet

DAC-Q28-S28-1M-C

Huawei® Compatible 100Gb/s QSFP28 to 4SFP28
Breakout Direct Attach Cable Copper, Passive, 1m

FEATURES

- Compatible with IEEE 802.3bj, IEEE 802.3by and InfiniBand EDR
- Supports aggregate data rates of 100Gbps
- Optimized construction to minimize insertion loss and cross talk
- Backward compatible with existing QSFP+ connectors and cages
- Pull-to-release slide latch design
- 26AWG through 30AWG cable
- Straight and break out assembly configurations available
- Customized cable braid termination limits EMI radiation
- Customizable EEPROM mapping for cable signature
- RoHS compliant

APPLICATIONS

- Switches, servers and routers
- Data Center networks

STORAGE AREA NETWORKS

- High performance computing
- Telecommunication and wireless infrastructure
- Medical diagnostics and networking
- Test and measurement equipment

INDUSTRIAL STANDARDS

- 100G Ethernet (IEEE 802.3bj)
- 25G Ethernet (IEEE 802.3by)
- InfiniBand EDR
- SFF-8665 QSFP+ 28G 4X Pluggable Transceiver Solution (QSFP28)
- SFF-8402 SFP+ 1X 28Gb/s Pluggable Transceiver Solution (SFP28)

Product Datasheet

DESCRIPTION

ATGBICS QSFP28 passive copper cable assembly feature eight differential copper pairs, providing four data transmission channels at speeds up to 28Gbps per channel, and meets 100G Ethernet, 25G Ethernet and InfiniBand Enhanced Data Rate (EDR) requirements. Available in a broad range of wire gages-from 26AWG through 30AWG-this 100G copper cable assembly features low insertion loss and low cross talk.

Designed for applications in the data center, networking and telecommunications markets that require a high speed, reliable cable assembly, this next generation product shares the same mating interface with QSFP+ form factor, making it backward compatible with existing QSFP ports. QSFP28 can be used with current 10G and 14G applications with substantial signal integrity margin.

High Speed Characteristics

Parameter	Symbol	Min	Typical	Max	Unit	Note
Differential Impedance	TDR	90	100	110	Ω	
Insertion loss	SDD21	-22.48			dB	At 12.8906 GHz
Differential Return Loss	SDD11			See 1	dB	At 0.05 to 4.1 GHz
	SDD22			See 2	dB	At 4.1 to 19 GHz
Common-mode to common-mode output return loss	SCC11			-2	dB	At 0.2 to 19 GHz
	SCC22					
Differential to common mode return loss	SCD11			See 3	dB	At 0.01 to 12.89 GHz
	SCD22			See 4		At 12.89 to 19 GHz
Differential to common Mode Conversion Loss	SCD21-IL			-10	dB	At 0.01 to 12.89 GHz
				See 5		At 12.89 to 15.7 GHz
				-6.3		At 15.7 to 19 GHz

Notes:

1. Reflection Coefficient given by equation $SDD11(dB) < -16.5 + 2 \times \text{SQRT}(f)$, with f in GHz
2. Reflection Coefficient given by equation $SDD11(dB) < -10.66 + 14 \times \log_{10}(f/5.5)$, with f in GHz
3. Reflection Coefficient given by equation $SCD11(dB) < -22 + (20/25.78) * f$, with f in GHz
4. Reflection Coefficient given by equation $SCD11(dB) < -15 + (6/25.78) * f$, with f in GHz
5. Reflection Coefficient given by equation $SCD21(dB) < -27 + (29/22) * f$, with f in GHz

Product Datasheet

QSF28 Pin Function Definition

Pin	Logic	Symbol	Description
1		GND	Ground
2	CML-I	Tx2n	Transmitter Inverted Data Input
3	CML-I	Tx2p	Transmitter Non-Inverted Data Input
4		GND	Ground
5	CML-I	Tx4n	Transmitter Inverted Data Input
6	CML-I	Tx4p	Transmitter Non-Inverted Data Input
7		GND	Ground
8	LVTTL-I	ModSelL	Module Select
9	LVTTL-I	ResetL	Module Reset
10		Vcc Rx	+3.3V Power Supply Receiver
11	LVCMOS-I/O	SCL	2-wire serial interface clock
	LVCMOS-I/O		
12		SDA	2-wire serial interface data
13		GND	Ground
14	CML-O	Rx3p	Receiver Non-Inverted Data Output
15	CML-O	Rx3n	Receiver Inverted Data Output
16		GND	Ground
17	CML-O	Rx1p	Receiver Non-Inverted Data Output
18	CML-O	Rx1n	Receiver Inverted Data Output
19		GND	Ground
20		GND	Ground
21	CML-O	Rx2n	Receiver Inverted Data Output
22	CML-O	Rx2p	Receiver Non-Inverted Data Output
23		GND	Ground
24	CML-O	Rx4n	Receiver Inverted Data Output
25	CML-O	Rx4p	Receiver Non-Inverted Data Output
26		GND	Ground
27	LVTTL-O	ModPrsL	Module Present
28	LVTTL-O	IntL	Interrupt
29		Vcc Tx	+3.3V Power supply transmitter
30		Vcc1	+3.3V Power supply
31	LVTTL-I	LPMode	Low Power Mode
32		GND	Ground
33	CML-I	Tx3p	Transmitter Non-Inverted Data Input
34	CML-I	Tx3n	Transmitter Inverted Data Input
35		GND	Ground
36	CML-I	Tx1p	Transmitter Non-Inverted Data Input
37	CML-I	Tx1n	Transmitter Inverted Data Input
38		GND	Ground

Product Datasheet

QSFP+ Pin Function Definition

Pin	Logic	Symbol	Description
1		GND	Ground
2	CML-I	Tx2n	Transmitter Inverted Data Input
3	CML-I	Tx2p	Transmitter Non-Inverted Data Input
4		GND	Ground
5	CML-I	Tx4n	Transmitter Inverted Data Input
6	CML-I	Tx4p	Transmitter Non-Inverted Data Input
7		GND	Ground
8	LVTTL-I	ModSelL	Module Select
9	LVTTL-I	ResetL	Module Reset
10		Vcc Rx	+3.3V Power Supply Receiver
11	LVC MOS-I/O	SCL	2-wire serial interface clock
12	LVC MOS-I/O	SDA	2-wire serial interface data
13		GND	Ground
14	CML-O	Rx3p	Receiver Non-Inverted Data Output
15	CML-O	Rx3n	Receiver Inverted Data Output
16		GND	Ground
17	CML-O	Rx1p	Receiver Non-Inverted Data Output
18	CML-O	Rx1n	Receiver Inverted Data Output
19		GND	Ground
20		GND	Ground
21	CML-O	Rx2n	Receiver Inverted Data Output
22	CML-O	Rx2p	Receiver Non-Inverted Data Output
23		GND	Ground
24	CML-O	Rx4n	Receiver Inverted Data Output
25	CML-O	Rx4p	Receiver Non-Inverted Data Output
26		GND	Ground
27	LVTTL-O	ModPrsL	Module Present
28	LVTTL-O	IntL	Interrupt
29		Vcc Tx	+3.3V Power supply transmitter
30		Vcc1	+3.3V Power supply

Product Datasheet

31	LVTTL-I	LPMode	Low Power Mode
32		GND	Ground
33	CML-I	Tx3p	Transmitter Non-Inverted Data Input
34	CML-I	Tx3n	Transmitter Inverted Data Input
35		GND	Ground
36	CML-I	Tx1p	Transmitter Non-Inverted Data Input
37	CML-I	Tx1n	Transmitter Inverted Data Input
38		GND	Ground

Mechanical Information

The connector is compatible with the SFF-8436 specification

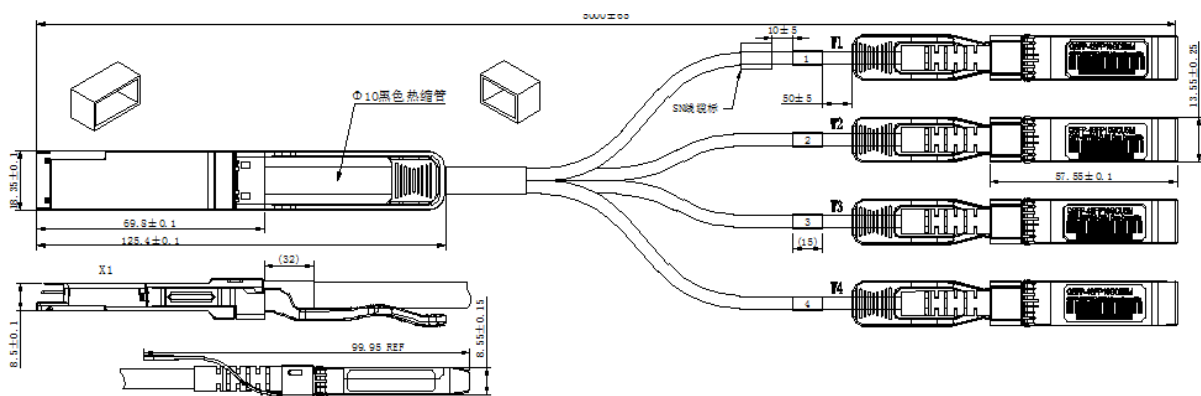

Length (m)	Cable AWG
1	30
2	30
3	26/30
4	26
5	26

General Product Characteristics

Q/4SFP+ DAC Specifications	
Number of Lanes	Tx & Rx
Channel Data Rate	10.3125 Gbps
Operating Temperature	0 to + 70°C
Storage Temperature	-40 to + 85°C
Supply Voltage	3.3 V nominal
Electrical Interface	38 pins edge connector (QSFP+) 20 pins edge connector (SFP+)
Management Interface	Serial, I2C

Product Datasheet

Regulatory Compliance

Feature	Test Method	Performance
Electrostatic Discharge (ESD) to the Electrical Pins	MIL-STD-883C Method 3015.7	Class 1 (>2000 Volts)
Electromagnetic Interference (EMI)	FCC Class B	Compliant with Standards
	CENELEC EN55022 Class B	
	CISPR22 ITE Class B	
RF Immunity (RFI)	IEC61000-4-3	Typically Show no Measurable Effect from a 10V/m Field Swept from 80 to 1000MHz
RoHS Compliance	RoHS Directive 2011/65/EU and it's Amendment Directives (EU) 2015/863	RoHS (EU) 2015/863 compliant
REACH Compliance	REACH Regulation (EC) No 1907/2006	REACH (EC) No 1907/2006 compliant