

## TINA3-OO

~60° + 40° oval beam. Assembly with holder, installation tape and location pins.

### SPECIFICATION:

Dimensions	Ø 16.1 mm
Height	6.9 mm
Fastening	tape, pin
ROHS compliant	yes ⓘ



### MATERIALS:

Component	Type	Material	Colour	Finish
TINA3-OO-XP	Single lens	PMMA	clear	
TINA3-HLD-PIN-TAPE	Holder	PC	white	
TINA-TAPE3	Tape	Acrylic foam	black	

### ORDERING INFORMATION:

Component		Qty in box	MOQ	MPQ	Box weight (kg)
CA12429_TINA3-OO	Single lens	5750	230	230	8.3
» Box size: 451 x 241 x 298 mm					

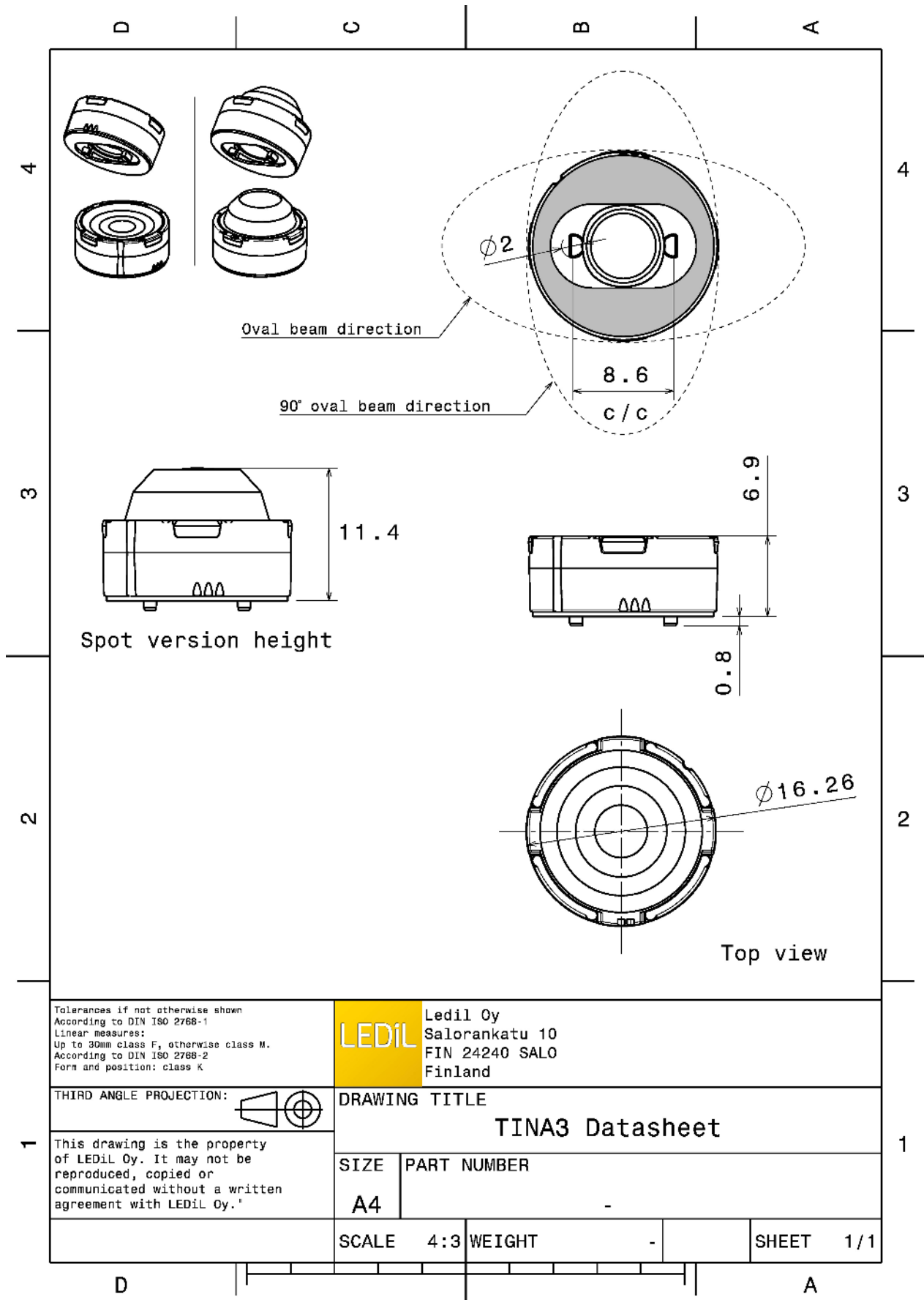

Tolerances if not otherwise shown  
According to DIN ISO 2768-1  
Linear measures:  
Up to 30mm class F, otherwise class M.  
According to DIN ISO 2768-2  
Form and position: class K



Ledil Oy  
Salorankatu 10  
FIN 24240 SALO  
Finland

THIRD ANGLE PROJECTION:

DRAWING TITLE

TINA3 Datasheet

This drawing is the property of LEDiL Oy. It may not be reproduced, copied or communicated without a written agreement with LEDiL Oy.

SIZE	PART NUMBER
A4	-

SCALE	4:3	WEIGHT	-	SHEET	1/1
-------	-----	--------	---	-------	-----

See also our general installation guide: [www.ledil.com/installation\\_guide](http://www.ledil.com/installation_guide)

#### OPTICAL RESULTS (MEASURED):

##### CREE LED

LED XP-G  
 FWHM / FWTM 51.0 + 35.0° / 82.0 + 70.0°  
 Efficiency 90 %  
 Peak intensity 1.4 cd/lm  
 LEDs/each optic 1  
 Light colour White  
 Required components:

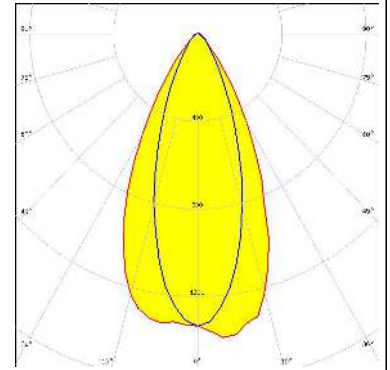

##### LUMILEDS

LED LUXEON A  
 FWHM / FWTM 57.0 + 29.0° / 86.0 + 74.0°  
 Efficiency 90 %  
 Peak intensity 1.2 cd/lm  
 LEDs/each optic 1  
 Light colour White  
 Required components:

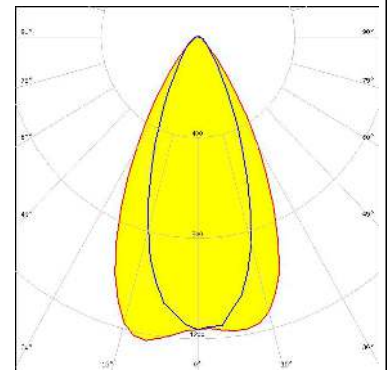

##### LUMILEDS

LED LUXEON T  
 FWHM / FWTM 58.0 + 40.0° / 85.0 + 72.0°  
 Efficiency 88 %  
 Peak intensity 1.2 cd/lm  
 LEDs/each optic 1  
 Light colour White  
 Required components:

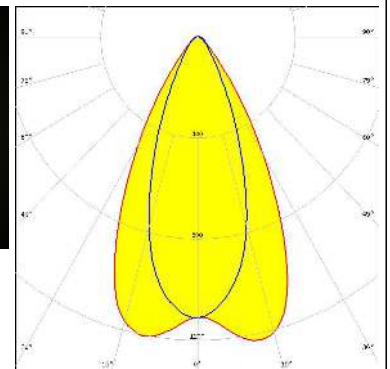
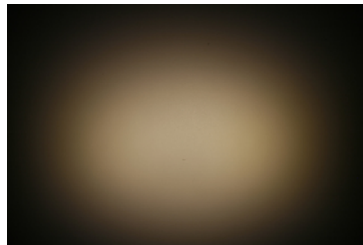

##### LUMILEDS

LED LUXEON TX  
 FWHM / FWTM 59.0 + 42.0° / 85.0 + 75.0°  
 Efficiency 88 %  
 Peak intensity 1.2 cd/lm  
 LEDs/each optic 1  
 Light colour White  
 Required components:

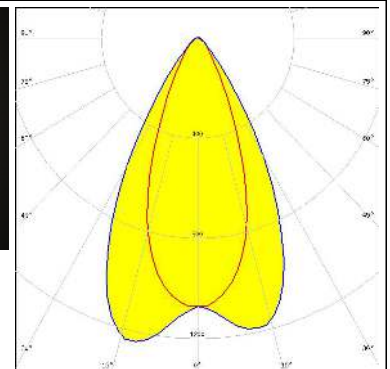
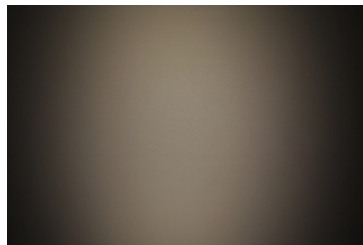

#### OPTICAL RESULTS (MEASURED):



LED NVSxx19A  
 FWHM / FWTM 61.0 + 45.0° / 91.0 + 81.0°  
 Efficiency 87 %  
 Peak intensity 1 cd/lm  
 LEDs/each optic 1  
 Light colour White  
 Required components:

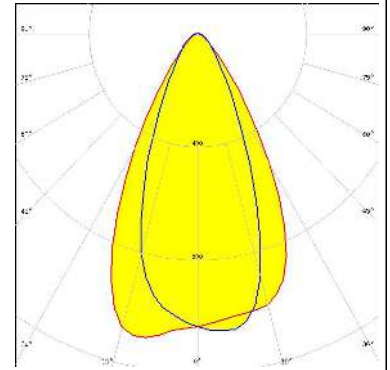

LED NVSxx19B/NVSxx19C  
 FWHM / FWTM 43.0° / 78.0°  
 Efficiency 86 %  
 Peak intensity 1.1 cd/lm  
 LEDs/each optic 1  
 Light colour White  
 Required components:

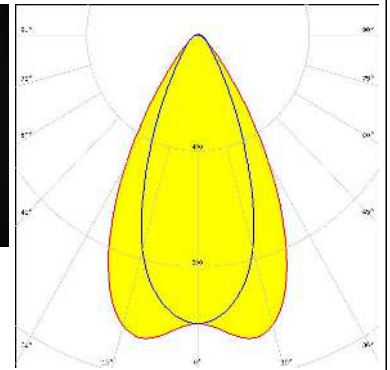
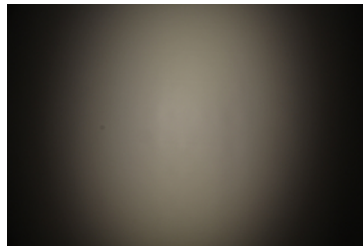

LED OSLOM Square EC  
 FWHM / FWTM 55.0 + 39.0° / 85.0 + 79.0°  
 Efficiency 88 %  
 Peak intensity 1.1 cd/lm  
 LEDs/each optic 1  
 Light colour White  
 Required components:

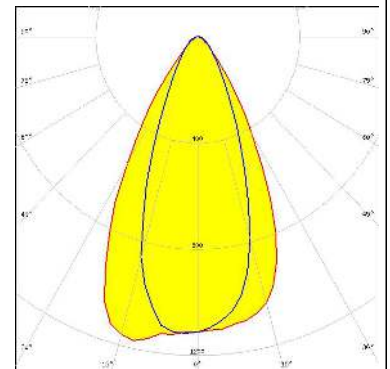

LED LH351Z  
 FWHM / FWTM 47.0 + 62.0° / 80.0 + 90.0°  
 Efficiency 88 %  
 Peak intensity 1.1 cd/lm  
 LEDs/each optic 1  
 Light colour White  
 Required components:

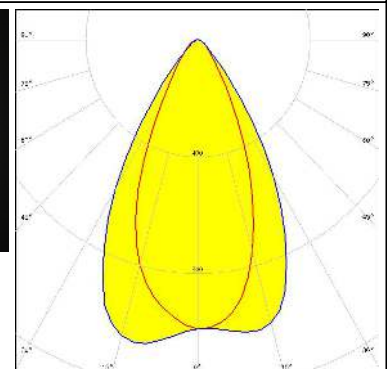
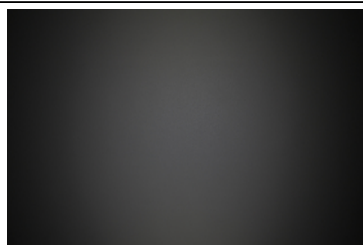

#### OPTICAL RESULTS (SIMULATED):

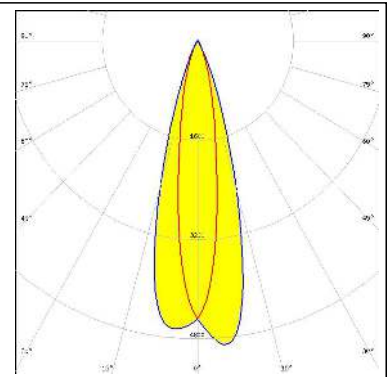
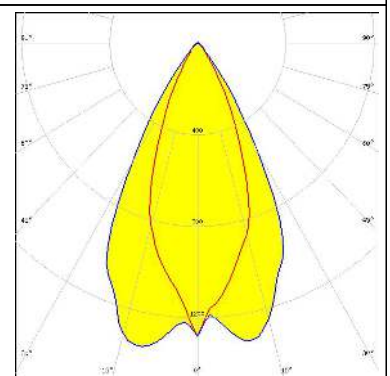
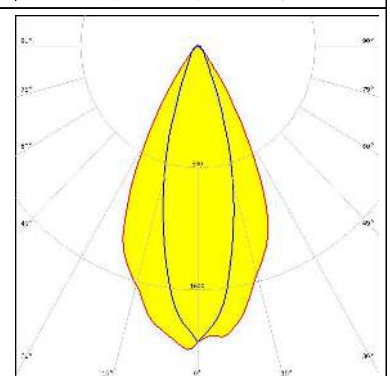
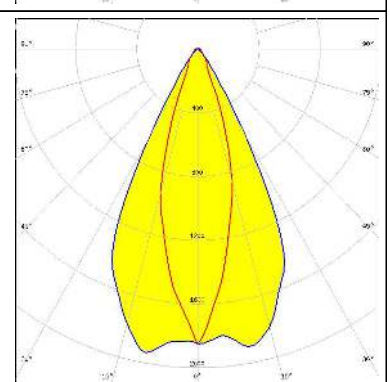
<p><b>LUMILEDS</b></p> <p>LED LUXEON 2835 Line</p> <p>FWHM / FWTM 16.0 + 30.0° / 40.0 + 48.0°</p> <p>Efficiency 99 %</p> <p>Peak intensity 4.9 cd/lm</p> <p>LEDs/each optic 1</p> <p>Light colour White</p> <p>Required components:</p>	
<p><b>LUMILEDS</b></p> <p>LED LUXEON H50-2</p> <p>FWHM / FWTM 37.0 + 57.0° / 68.0 + 80.0°</p> <p>Efficiency 87 %</p> <p>Peak intensity 1.3 cd/lm</p> <p>LEDs/each optic 1</p> <p>Light colour White</p> <p>Required components:</p>	
<p><b>OSRAM</b> Opto Semiconductors</p> <p>LED OSCONIQ P 3030</p> <p>FWHM / FWTM 52.0 + 29.0° / 76.0 + 53.0°</p> <p>Efficiency 94 %</p> <p>Peak intensity 2 cd/lm</p> <p>LEDs/each optic 1</p> <p>Light colour White</p> <p>Required components:</p>	
<p><b>OSRAM</b> Opto Semiconductors</p> <p>LED SYNIOS S2222</p> <p>FWHM / FWTM 29.0 + 54.0° / 52.0 + 72.0°</p> <p>Efficiency 95 %</p> <p>Peak intensity 1.9 cd/lm</p> <p>LEDs/each optic 1</p> <p>Light colour White</p> <p>Required components:</p>	

## OPTICAL RESULTS (SIMULATED):

### SAMSUNG

LED	LH351B
FWHM / FWTM	Asymmetric
Efficiency	93 %
Peak intensity	1.2 cd/lm
LEDs/each optic	1
Light colour	White
Required components:	

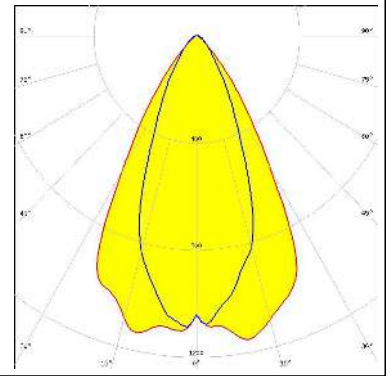

### GENERAL INFORMATION:

NOTE: The typical beam angle will be changed by different color, chip size and chip position tolerance. The typical total beam angle is the full angle measured where the luminous intensity is half of the peak value.

### MATERIALS:

As part of our continuous research and improvement processes, and to ensure the best possible quality and availability of our products, LEDiL reserves the right to change material grades without notice.

### PRODUCT DATA USER AGREEMENT AND DISCLAIMER:

The measured data in the provided downloadable LEDiL Product Datasheets and Mechanical 2D-Drawings is rounded and provided as reference for planning. LEDiL Oy's optical specifications have been verified by conducting performance testing of the products in accordance with the company's quality system. The reported data are averaged results of multiple measurements with typical variation. LEDiL Oy reserves the right to without prior notification make changes and improvements to its products.

LEDiL Oy assumes neither warranty, nor guarantee nor any other liability of any kind for the contents and correctness of the provided data. The provided data has been generated with highest diligence but the provided data may in reality not represent the complete possible variation range of all intrinsic parameters. Therefore, in certain cases a deviation from the provided data could occur.

LEDiL Oy reserves the right to undertake technical changes of its products without further notification which could lead to changes in the provided data. LEDiL Oy assumes no liability of any kind for the possible deviation from any provided data or any other damage resulting from the usage of the provided data.

The user agrees to this disclaimer and user agreement with the download or usage of the provided files.

#### LEDiL Oy

Joensuunkatu 13  
FI-24240 SALO  
Finland

#### LEDiL Inc.

228 West Page Street  
Suite D  
Sycamore IL 60178  
USA

#### Ledil Optics Technology (Shenzhen) Co., Ltd.

# 405 , Block B  
Casic Motor Building  
Shenzhen 518057  
P.R.CHINA

#### Local sales and technical support

[www.ledil.com/  
where\\_to\\_buy](http://www.ledil.com/where_to_buy)

#### Shipping locations

Salo, Finland  
Hong Kong, China

#### Distribution Partners

[www.ledil.com/  
where\\_to\\_buy](http://www.ledil.com/where_to_buy)