

SPECIFICATION

SPECIFICATION No.

To

DATE: 2017.11.10

CUSTOMER'S PRODUCT NAME :

TDK PRODUCT NAME:
TMR Angle Sensor
TAS4142-BAAC

RECEIPT CONFIRMATION

Sales :

APPROVED	
DATE	

Production :

APPROVED		
DATE		

QA :

APPROVED	Person in charge
DATE	DATE

Engineering :

APPROVED	CHECKED	Person in charge
DATE	DATE	DATE

DIVISION	PRODUCT NAME	DATE.	PAGE
TDK	TAS4142-BAAC	2017.11.10	- 1 -

【 Changes】

Date	Rev	changes
2016.06.8	00	New release
2017.09.25	01	Update package drawing
2017.11.10	02	Update "11. Recommended Operating Conditions" in page.7 Update "12. Characteristics" in page.7-8 Update "13. Package Dimension" in page.9

DIVISION	PRODUCT NAME	DATE.	PAGE
TDK	TAS4142-BAAC	2017.11.10	- 2 -

Contents

1. General description
2. Key Features
3. Typical Applications
4. Operation
5. Definition of Angle and Direction
6. Absolute Maximum Rating
7. Thermal Characteristics
8. Pin assignment
9. Internal circuit and Pin direction
10. Output Signal
11. Recommended Operating Conditions
12. Characteristics
13. Package dimension
14. Matters to be attended to

DIVISION	PRODUCT NAME	DATE.	PAGE
TDK	TAS4142-BAAC	2017.11.10	- 3 -

1. General description

The TAS4142-BAAC TDK Angle Sensor is Tunneling Magneto Resistance (TMR) sensor which consists of 4 Wheatstone bridges in TSSOP16 package, which output creates 3.0Vp-p @ Vcc 5V. The output can be configured to represent one pair of sine and cosine functions by applied magnetic field in x-y plane and its sensor can detect 360deg/ 1 rotation. Sine and cosine bridges are layout 90deg to one another. More than 20mT magnetic field is suitable for high precision angle measurement.

2. Key Features

- Magnetic field sensor, employing the TMR (Tunneling Magnet Resistance) effect.
- 2 x 2 full bridge (Sine and Cosine Outputs) in inside of TSSOP-16 package.
- Sine and Cosine Outputs.
- Good redundancy performance
- Very High Output Signal without Amplification.

3. Typical Applications

- Absolute Rotary Angle Sensor.
- EPS Motor-shaft Angle Sensor.
- Steering Wheel Angle Sensor.
- Pedal Position Sensor.
- Throttle Position Sensor.

DIVISION	PRODUCT NAME	DATE.	PAGE
TDK	TAS4142-BAAC	2017.11.10	- 4 -

4. Operation

Free layer aligns with Applied Magnetic Field.

Angle between Pin and Free layers determines resistance.

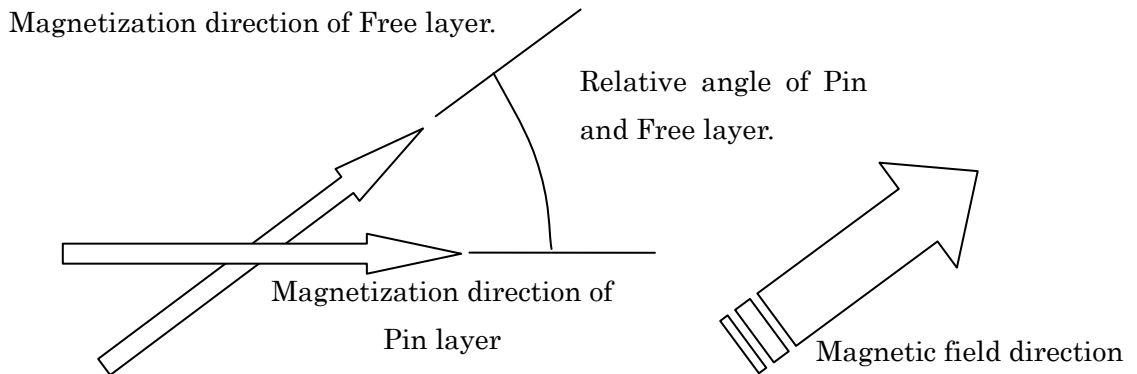

5. Definition of Angle and Direction

The definition of Direction of magnetic field detection is as follows.

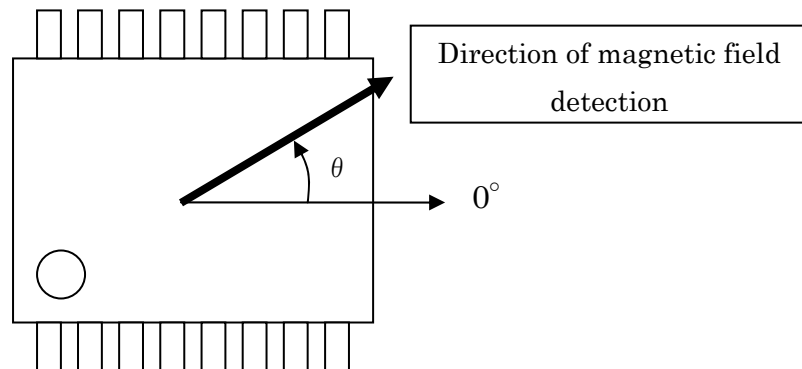

6. Absolute Maximum Ratings

Items	Parameter	Conditions	Min	Typ	Max	Unit	Remarks
Vcc	Supply Voltage				6.5	Volt	
Hex	External Magnetic field	Max. 5min @25degC			200	mT 1)	1)
ESD HBM	ESD tolerance : Human Body Model				4000	Volt	
ESD MM	ESD tolerance : Machine Model				400	Volt	
Topt	Operating Ambient Temperature		-40		150	deg C	
Tstg	Storage Temperature		-55		150	deg C	
Treflow	Reflow Temperature				260	deg C	

1) 1mT = 795.8A/m. in air

DIVISION	PRODUCT NAME	DATE.	PAGE
TDK	TAS4142-BAAC	2017.11.10	- 5 -

7. Thermal Characteristics

Items	Parameter	Conditions	Min	Typ	Max	Unit	Remarks
Rth(j-a)	Thermal Resistance from junction to ambient			91		K/W	

8. Pin assignment

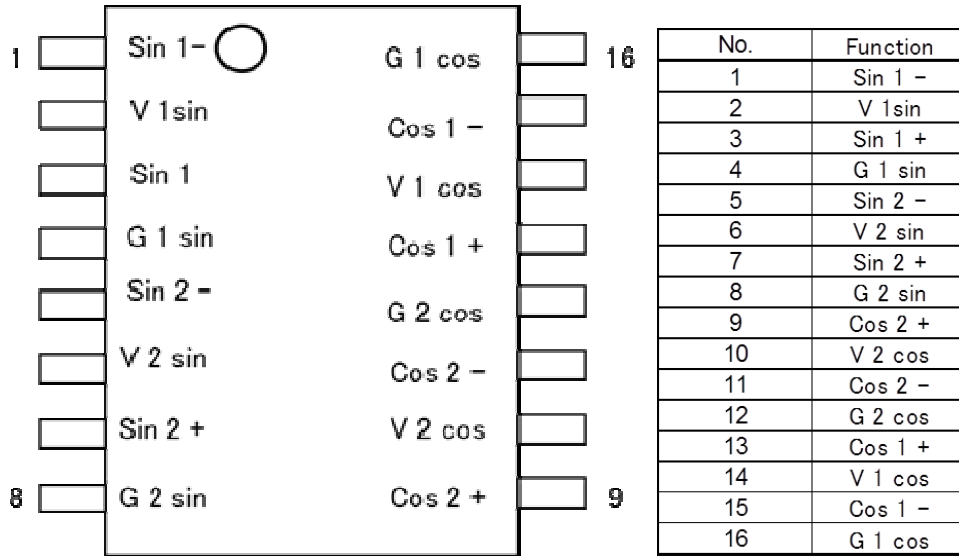

9. Internal circuit and Pin direction

White and gray arrows indicate magnetization direction of Pin layer.

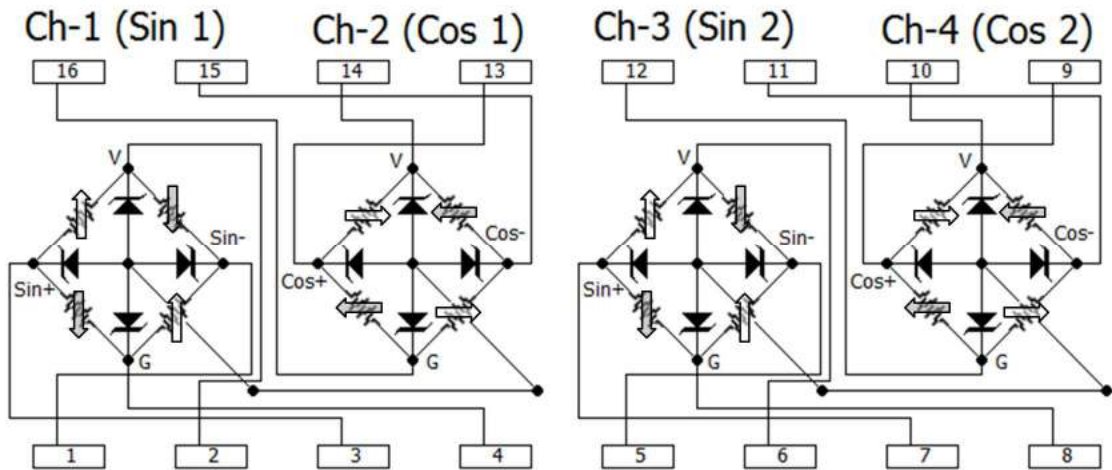

DIVISION	PRODUCT NAME	DATE.	PAGE
TDK	TAS4142-BAAC	2017.11.10	- 6 -

10. Output Signal(Differential Output Voltage)

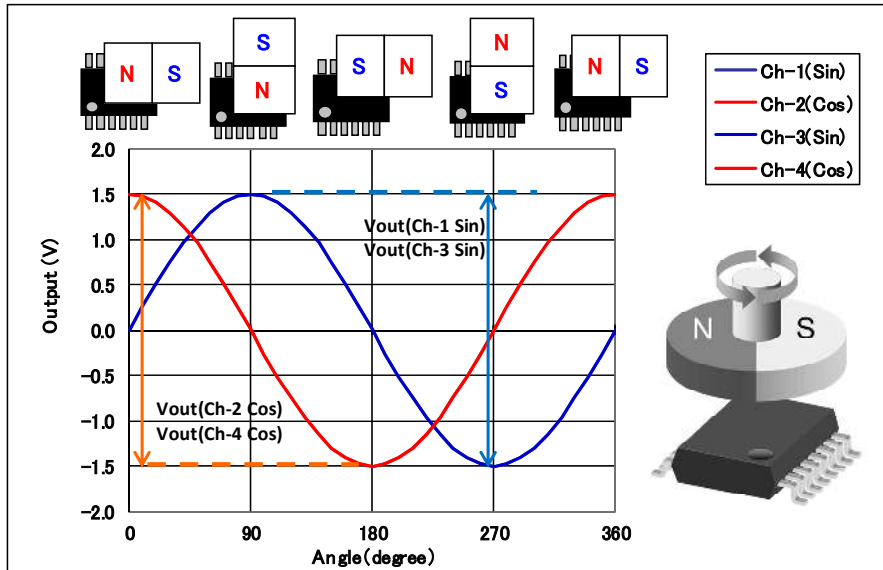

11. Recommended Operating Conditions

Items	Parameter	Conditions	Min	Typ	Max	Unit	Remarks
Vcc	Supply Voltage		3	5	5.5	Volt	
Topt	Operating Temperature		-40	25	150	degC	
Hex	External Magnetic Field	Recommended Range	20		80	mT	
		Extended Range	80		120	mT	1)

1) See possible angle error on Characteristics table.

12. Characteristics

TOPT=25° C, BEXT=30mT, VSIN=2.7 to 5.5V, VCOS=2.7 to 5.5V unless otherwise specified

Items	Parameter	Conditions	Min	Typ	Max	Unit	Remarks
Rbridge	Bridge Resistance	Topt=25degC, Hex=20mT	4	5	6	KΩ	
Vout	Differential output voltage peak to peak per Vcc	Topt=25degC, Hex=20mT	0.54	0.6	0.67	V/V	1)
Angle Error (After Compensation)		Topt=-40degC to 150degC Nominal magnetic Range: 20mT to 80mT 1000h			0.8	deg	2)
		Topt=-40degC to 150degC Extended magnetic Range 80mT to 120mT 1000h			1.2	deg	2), 9)
Orthogonality		Topt=-40degC to 150degC 20mT to 80mT 0h	87	90	93	deg	3)
Voffset	Differential Output Offset as an "initial offset"	per supply voltage 20mT to 80mT	-5	-	5	mV/V	
TCoutput	Temperature Coefficient of Differential Output	Topt=-40degC to 150degC 20mT to 80mT	-0.115	-0.095	-0.075	%/K	4)
TCRbridge	Temperature Coefficient of Bridge Resistance	Topt=-40degC to 150degC 20mT to 80mT	-0.070	-0.050	-0.030	%/K	5)
Off.TD	Offset Temperature Drift	Topt=-40degC to 150degC 20mT to 80mT	-0.5	0	0.5	mV/V	6)
Hyst	Hysteresis of Output Voltage	more than Hex=20mT	No Hysteresis				
k	Amplitude Synchronism ratio	Topt=25degC, Hex=20mT	97	100	103	%	7)
Tck	Temperature Coefficient of Amplitude Synchronism	Topt=-40degC to 150degC 20mT to 80mT	-0.015		0.015	%/K	8)

* LT=-40degC., RT=25degC., HT=150degC.

DIVISION	PRODUCT NAME	DATE.	PAGE
TDK	TAS4142-BAAC	2017.11.10	- 7 -

1) V_{p-p} =differential output voltage peak to peak

$$V_{out} = \frac{V_{p-p}}{V_{CC}}$$

2) Angle error is defined by zero-to-peak.

Angle error of either LT or HT is compensated using the correction factor at RT
(Offset, Gain and Phase compensation according TDK application note No. EAZ00011)

3) Orthogonality is defined by reference to the 90 deg.

$$TC_{output} = \frac{(V_{out}(150degC) - V_{out}(-40degC))}{V_{out}(25degC) * (150degC - (-40degC))} * 100$$

$$TC_{rbridge} = \frac{(R_{bridge}(150degC) - R_{bridge}(-40degC))}{R_{bridge}(25degC) * (150degC - (-40degC))} * 100$$

$$Off.TD = V_{offset@Ta} - V_{offset@25degC}$$

※ $T_a = -40, 150degC$

$$k = \frac{V_{cos\ peak}}{V_{sin\ peak}}$$

$$TC_k = \frac{k(150degC) - k(-40degC)}{150degC - (-40degC)}$$

9) This value is verified by design & characterization, not subject to production test.

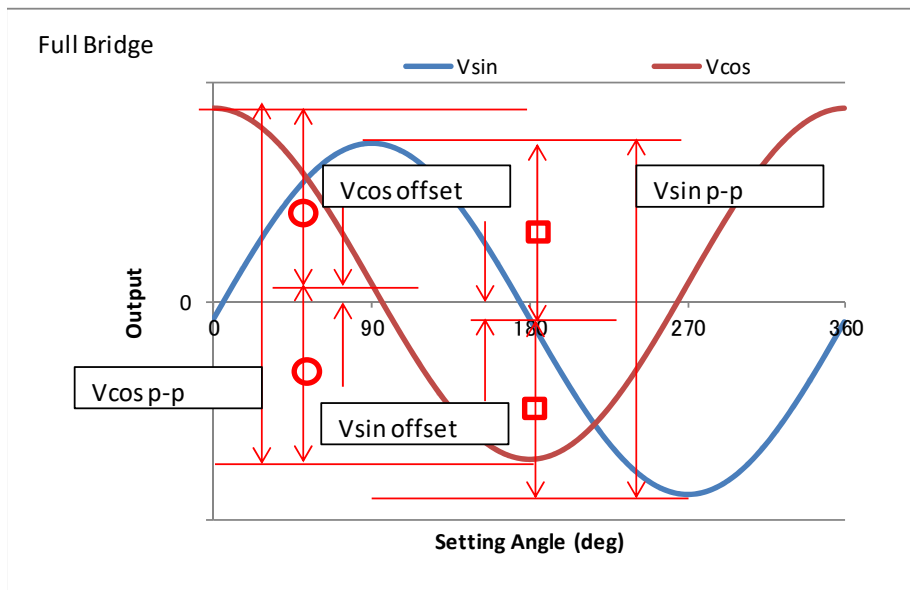

DIVISION	PRODUCT NAME	DATE.	PAGE
TDK	TAS4142-BAAC	2017.11.10	- 8 -

13. Package dimension unit: mm

2 x 2 full bridges / 1 package (TSSOP 16pin package 5.0mm x 4.4mm x 1.0mm)

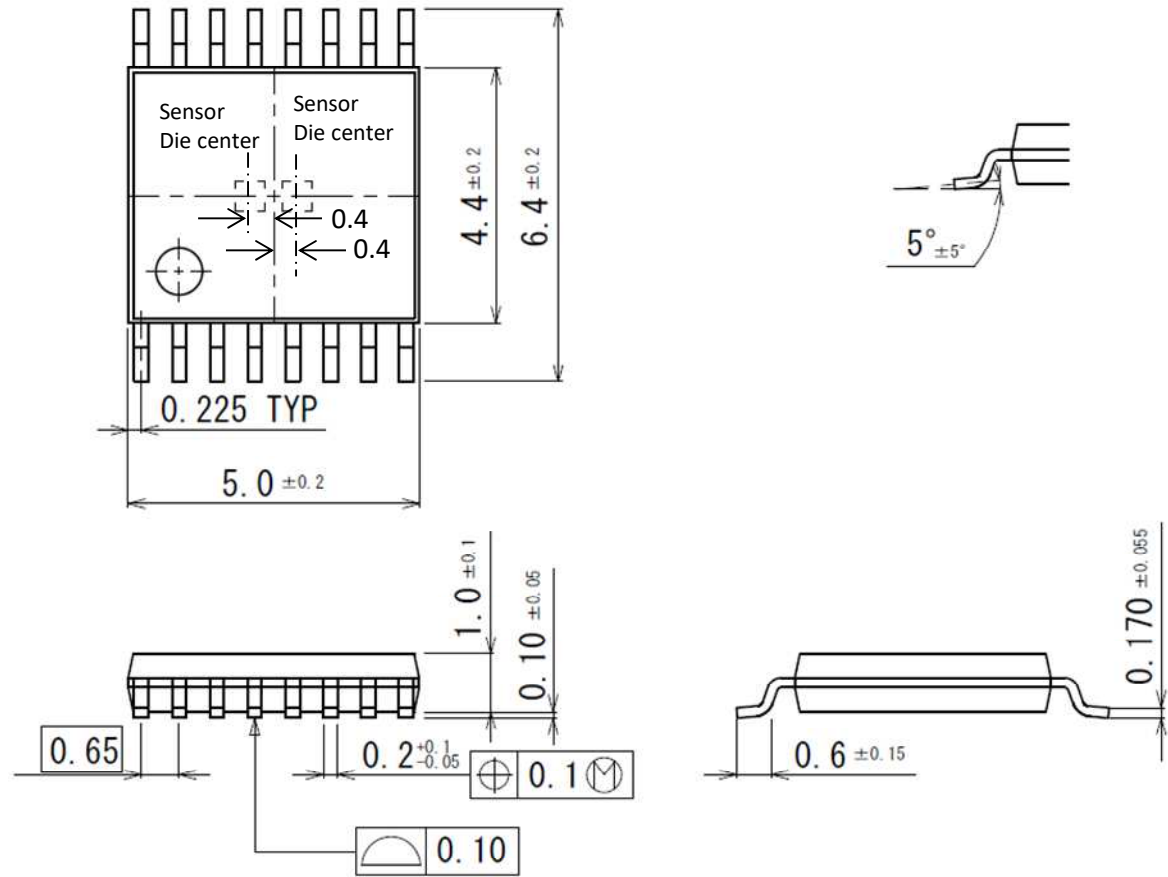

Sensor die layout (TAS4142, TSSOP-16)

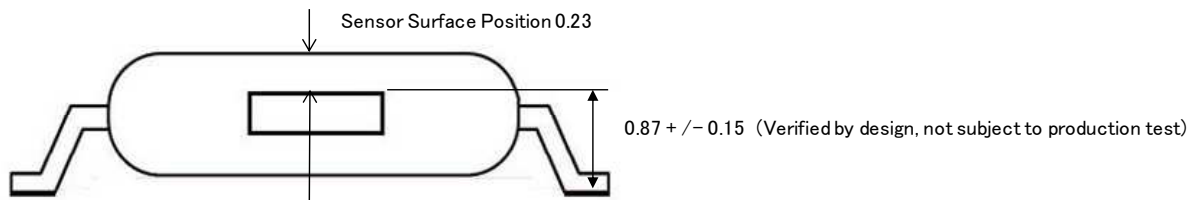

Sensor die location tolerance in package

	Min	Max	Unit
Position eccentricity	-100	100	um
Rotation	-2	2	degree
Tilt	-3	3	degree

Tilt value is verified by design & characterization, not subject to production test.

DIVISION	PRODUCT NAME	DATE.	PAGE
TDK	TAS4142-BAAC	2017.11.10	- 9 -

14. Matters to be attended to

- This material is under development product-information. All contents may change without notice.
- When you consider to use this product, please confirm to us that this material is up to date.
- We assume no responsibility that the infringement of third party rights caused by the information in this document.
- When you use this product to Equipment and equipment related to life purpose and potentially more serious damage, you must obtain agreement from us.
- Please note. We assume no responsibility If you have damage from its use without our agreement.

DIVISION	PRODUCT NAME	DATE.	PAGE
TDK	TAS4142-BAAC	2017.11.10	- 10 -