

Contact Code

540-Wire Wrap (w/ Wire Hole) .060x.025(1.52x0.64) - Tail
 LG.=.774(18.90)

THIS IS A C.A.D. GENERATED DRAWING
 DO NOT MAKE MANUAL REVISIONS TO MASTER.



ISSUE NUMBER

ORIGINAL ①

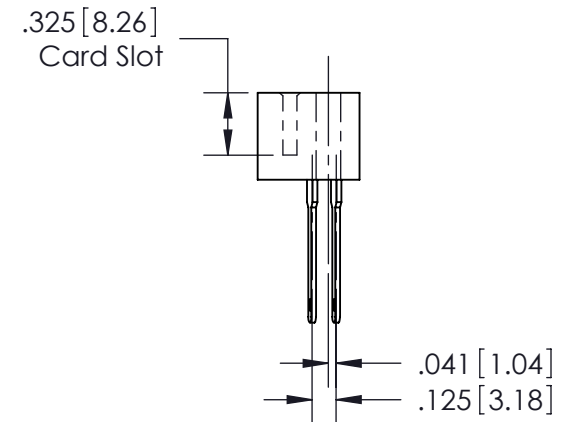
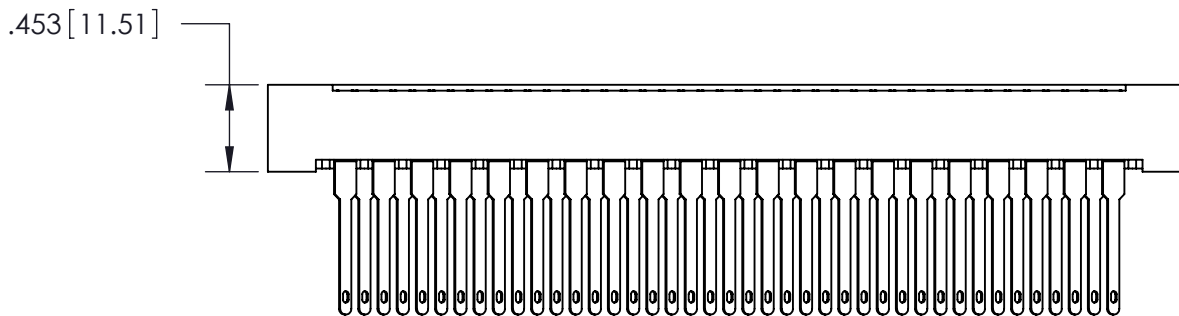
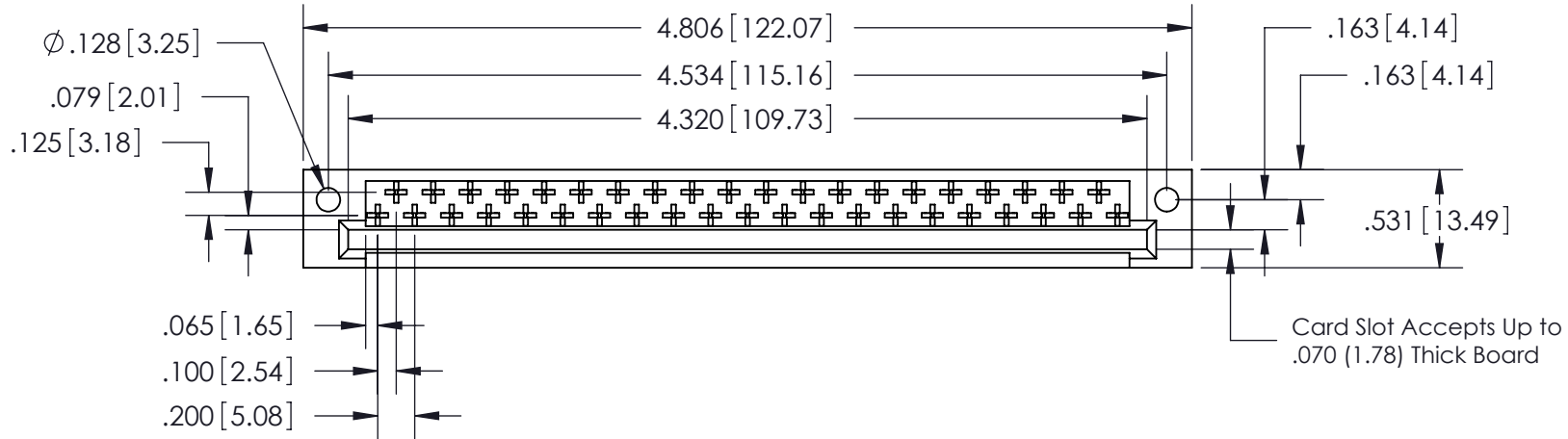

See Accompanying Pages for:
 • Features and Specifications

408/424 Series High Reliability Interlock Connector
 PART NUMBER: 408-041-540-122



EDAC INC
 TORONTO, ONTARIO
 CANADA

YOUR CONNECTION TO QUALITY & SERVICE

THESE DRAWINGS AND SPECIFICATIONS
 ARE THE PROPERTY OF EDAC INC. AND
 SHALL NOT BE REPRODUCED, OR COPIED
 OR USED AS THE BASIS FOR THE
 MANUFACTURE OR SALE OF APPARATUS
 WITHOUT WRITTEN PERMISSION.

ACAD REFERENCE NO. 408-ENG-MASTER	
DRAWN: J.LEE	DATE: SEPT. 16/09
CHECKED:	DATE:
SCALE: NTS	SHEET 1 OF 1
DRAWING NUMBER 408-ENG-MASTER	ISSUE 1