



Bridgelux® Vero® SE 10 Array

Product Data Sheet DS120



Introduction

Vero SE



Vero® SE Series is a revolutionary light source system that integrates Bridgelux's seventh generation COB technology with poke-in connectivity enabling solder-free installation. Vero SE LED light sources streamline assembly processes, lower manufacturing cost, simplify luminaire design, improve light quality and increase design flexibility.

Vero SE is available in four different light emitting surface (LES) configurations that operate reliably over a broad current range. With Vero SE, secondary connector and holder components are not required, allowing for rapid integration of arrays into fixtures and an efficient field replaceable solution. Vero SE arrays deliver increased lumen density for improved beam control and precision lighting with 2 and 3 SDCM color control standards for clean and consistent uniform lighting.

Bridgelux Décor Series is our state of the art color line designed specifically for premium applications, producing unmatched LED light quality with brilliant color-rendering options and offer pleasing and inspiring lighting palettes. Bridgelux Décor Series color points are available on Vero® SE Series, Vero® Series, V Series™ and V Series™ HD.

Décor Series™ Class A is based on human response testing, providing color points with a combined GAI and CRI metric.

Décor Series™ Ultra products provide a high CRI of 97 and a minimum Rg value of 93, which emphasizes the reds and color tones to which the human eye is most receptive - perfect for the most luxurious retail shops and world renowned museums. Décor Series Ultra is also a good replacement for halogen lamps.

Décor Series™ Street and Landmark is designed to be a direct replacement for high pressure sodium lamps.

Décor Series™ Showcase is the optimal solution for replacing ceramic metal halide lamps, incorporating the same pure white light with enhanced spectrum coverage and higher efficacy.

Features

- Poke-in connectivity
- Efficacy of 162 lm/W typical
- Broad range of CCT options from 2700K to 6500K
- CRI options: minimum 65, 70, 80, and 90
- Color control: 2 and 3 SDCM for 2700K-4000K CCT
- Reliable operation at up to 2X nominal drive current
- Radial die pattern and improved lumen density
- Top side part number markings
- No exposed solder pads or electrical connections
- V_f bin code backside marking

Benefits

- Poke-in connectivity enables solderless, connector free installation
- Broad application coverage for interior and exterior lighting
- Flexibility for application driven lighting design requirements
- High quality, true color reproduction
- Uniform consistent white light
- Flexibility in design optimization
- Enhanced ease of use and assembly
- Ability to configure multiple Vero SE arrays in series and parallel reduces customer driver cost
- Improved inventory management and quality control



Contents

Product Feature Map	2
Product Nomenclature	2
Product Selection Guide	3
European Product Registry for Energy Labeling	10
Performance at Commonly Used Drive Currents	13
Electrical Characteristics	22
Eye Safety	23
Absolute Maximum Ratings	24
Performance Curves	25
Typical Radiation Pattern	28
Typical Color Spectrum	29
Mechanical Dimensions	30
Color Binning Information	31
Packaging and Labeling	32
Design Resources	34
Precautions	34
Disclaimers	34
About Bridgelux	35

Product Feature Map

Vero SE 10 is the smallest form factor in the product family of next generation solid state light sources. In addition to delivering the performance and light quality required for many lighting applications,

Vero SE incorporates several features to simplify the design integration and manufacturing process, accelerate time to market and reduce system costs. Please visit www.bridgelux.com for more information on the Vero SE family of products.

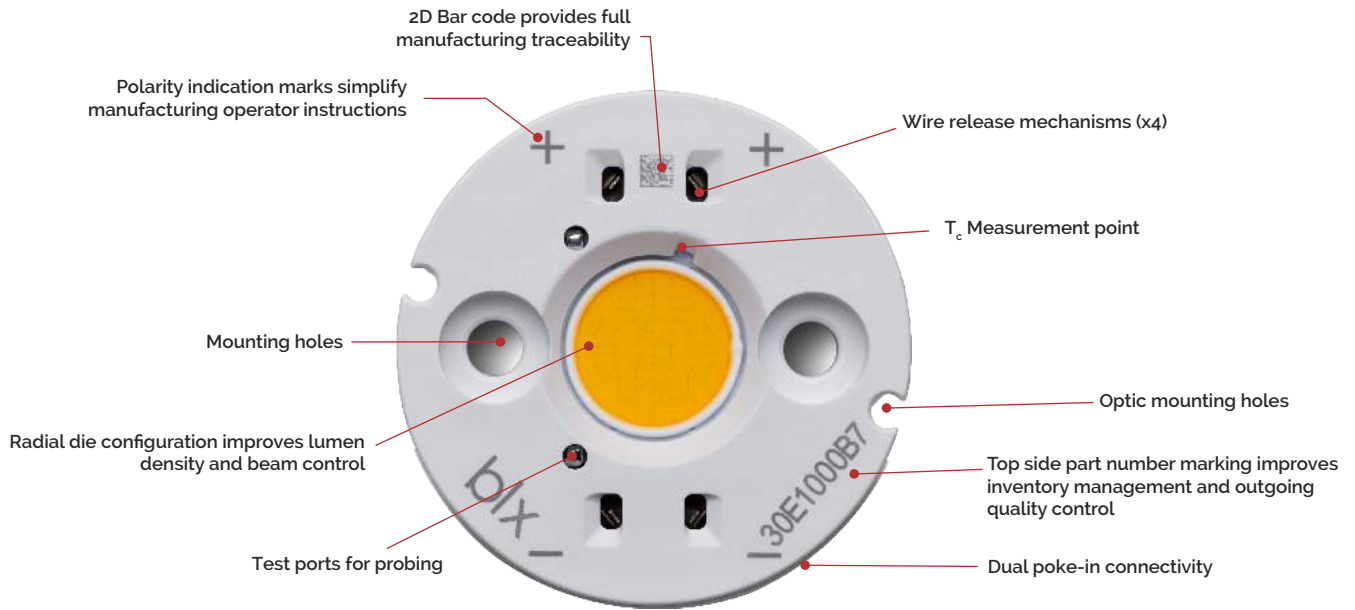

Product Nomenclature

The part number designation for Bridgelux Vero SE LED arrays is explained as follows:

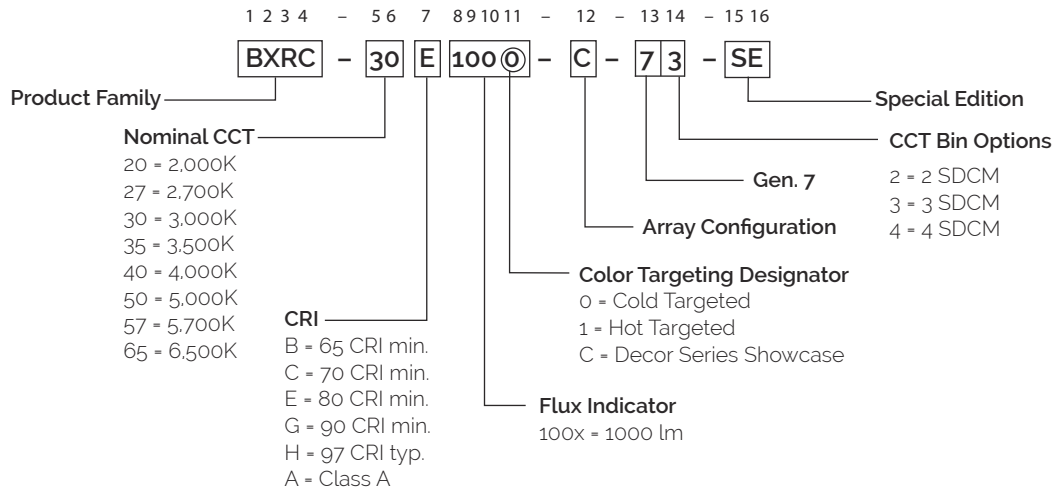

Product Selection Guide

The following product configurations are available:

Table 1: Selection Guide, Pulsed Measurement Data ($T_j = T_c = 25^\circ\text{C}$)

Part Number	Nominal CCT ¹ (K)	CRI ²	Nominal Drive Current ³ (mA)	Typical Pulsed Flux ^{4,5,6} $T_c = 25^\circ\text{C}$ (lm)	Minimum Pulsed Flux ^{6,7} $T_c = 25^\circ\text{C}$ (lm)	Typical V_f (V)	Typical Power (W)	Typical Efficacy (lm/W)
BXRC-20B1001-B-73-SE	2000	65	270	1391	1224	34.8	9.4	148
BXRC-20B1001-D-73-SE	2000	65	350	1347	1185	26.0	9.1	148
BXRC-27E1000-B-7x-SE	2700	80	270	1417	1247	34.8	9.4	151
BXRC-27E1000-C-7x-SE	2700	80	360	1890	1663	34.8	12.5	151
BXRC-27E1000-D-7x-SE	2700	80	350	1373	1208	26.0	9.1	151
BXRC-27G10H0-B-7x-SE	2700	90	270	1214	1068	34.8	9.4	129
BXRC-27G10H0-C-7x-SE	2700	90	360	1618	1424	34.8	12.5	129
BXRC-27G10H0-D-7x-SE	2700	90	350	1175	1034	26.0	9.1	129
BXRC-27G1000-B-7x-SE	2700	90	270	1169	1029	34.8	9.4	124
BXRC-27G1000-C-7x-SE	2700	90	360	1559	1372	34.8	12.5	124
BXRC-27G1000-D-7x-SE	2700	90	350	1133	997	26.0	9.1	124
BXRC-27H1000-B-7x-SE	2700	97	270	1036	912	34.8	9.4	110
BXRC-27H1000-C-7x-SE	2700	97	360	1382	1216	34.8	12.5	110
BXRC-27H1000-D-7x-SE	2700	97	350	1004	883	26.0	9.1	110
BXRC-30C1001-B-74-SE	3000	70	270	1577	1388	34.8	9.4	168
BXRC-30C1001-C-74-SE	3000	70	360	2103	1850	34.8	12.5	168
BXRC-30C1001-D-74-SE	3000	70	350	1527	1344	26.0	9.1	168
BXRC-30E1000-B-7x-SE	3000	80	270	1506	1325	34.8	9.4	160
BXRC-30E1000-C-7x-SE	3000	80	360	2008	1767	34.8	12.5	160
BXRC-30E1000-D-7x-SE	3000	80	350	1459	1284	26.0	9.1	160
BXRC-30G10H0-B-7x-SE	3000	90	270	1276	1123	34.8	9.4	136
BXRC-30G10H0-C-7x-SE	3000	90	360	1701	1497	34.8	12.5	136
BXRC-30G10H0-D-7x-SE	3000	90	350	1235	1087	26.0	9.1	136
BXRC-30G1000-B-7x-SE	3000	90	270	1223	1076	34.8	9.4	130
BXRC-30G1000-C-7x-SE	3000	90	360	1630	1434	34.8	12.5	130
BXRC-30G1000-D-7x-SE	3000	90	350	1184	1042	26.0	9.1	130
BXRC-30G100C-B-73-SE	3000	90	270	1178	1037	34.8	9.4	125
BXRC-30G100C-D-73-SE	3000	90	350	1141	1004	26.0	9.1	125
BXRC-30H1000-B-7x-SE	3000	97	270	1107	974	34.8	9.4	118
BXRC-30H1000-C-7x-SE	3000	97	360	1476	1299	34.8	12.5	118
BXRC-30H1000-D-7x-SE	3000	97	350	1072	944	26.0	9.1	118
BXRC-30A1001-B-73-SE ^{8,9}	3000	93	270	1099	967	34.8	9.4	117
BXRC-30A1001-C-73-SE ^{8,9}	3000	93	360	1465	1289	34.8	12.5	117
BXRC-30A1001-D-73-SE ^{8,9}	3000	93	350	1064	936	26.0	9.1	117

Notes for Table 1:

- Nominal CCT as defined by ANSI C78.377-2011. Products with a CCT of 5000K-6500K are hot targeted to $T_c = 85^\circ\text{C}$.
- CRI values are typical for Decor Series Ultra, Decor Series Street and Landmark and Decor Series Class A products. CRI values are minimums for all other products. Minimum R_g value for 80 CRI products is 0, the minimum R_g values for 90 CRI products is 50, the minimum R_g values for 97 CRI products is 93. Bridgelux maintains a ± 3 tolerance on CRI and R_g values.
- Drive current is referred to as nominal drive current.
- Products tested under pulsed condition (10ms pulse width) at nominal test current where T_j (junction temperature) - T_c (case temperature) = 25°C .
- Typical performance values are provided as a reference only and are not a guarantee of performance.
- Bridgelux maintains a $\pm 7\%$ tolerance on flux measurements.
- Minimum flux values at the nominal test current are guaranteed by 100% test.
- Nominal CCT is defined by the Lighting Research Center's Class A definition. The center of the Class A color bin is on the corresponding isothermal line.
- GAI value is 80. To help ensure optimal fixture level performance, GAI is measured at the fixture level, on axis, at a case temperature of 70°C . GAI may vary depending on fixture design and performance.

Product Selection Guide

Table 1: Selection Guide, Pulsed Measurement Data ($T_j = T_c = 25^\circ\text{C}$) (continued)

Part Number	Nominal CCT ¹ (K)	CRI ²	Nominal Drive Current ³ (mA)	Typical Pulsed Flux ^{4,5,6} $T_c = 25^\circ\text{C}$ (lm)	Minimum Pulsed Flux ^{6,7} $T_c = 25^\circ\text{C}$ (lm)	Typical V_f (V)	Typical Power (W)	Typical Efficacy (lm/W)
BXRC-35E1000-B-7x-SE	3500	80	270	1541	1356	34.8	9.4	164
BXRC-35E1000-C-7x-SE	3500	80	360	2055	1809	34.8	12.5	164
BXRC-35E1000-D-7x-SE	3500	80	350	1493	1314	26.0	9.1	164
BXRC-35G1000-B-7x-SE	3500	90	270	1267	1115	34.8	9.4	135
BXRC-35G1000-C-7x-SE	3500	90	360	1689	1486	34.8	12.5	135
BXRC-35G1000-D-7x-SE	3500	90	350	1227	1080	26.0	9.1	135
BXRC-35A1001-B-73-SE ^{8,9}	3500	93	270	1169	1029	34.8	9.4	124
BXRC-35A1001-C-73-SE ^{8,9}	3500	93	360	1559	1372	34.8	12.5	124
BXRC-35A1001-D-73-SE ^{8,9}	3500	93	350	1133	997	26.0	9.1	124
BXRC-40C1001-B-74-SE	4000	70	270	1621	1427	34.8	9.4	173
BXRC-40C1001-C-74-SE	4000	70	360	2162	1902	34.8	12.5	173
BXRC-40C1001-D-74-SE	4000	70	350	1570	1382	26.0	9.1	173
BXRC-40E1000-B-7x-SE	4000	80	270	1550	1364	34.8	9.4	165
BXRC-40E1000-C-7x-SE	4000	80	360	2067	1819	34.8	12.5	165
BXRC-40E1000-D-7x-SE	4000	80	350	1501	1321	26.0	9.1	165
BXRC-40G1000-B-7x-SE	4000	90	270	1293	1138	34.8	9.4	138
BXRC-40G1000-C-7x-SE	4000	90	360	1725	1518	34.8	12.5	138
BXRC-40G1000-D-7x-SE	4000	90	350	1253	1102	26.0	9.1	138
BXRC-40H1000-B-7x-SE	4000	97	270	1169	1029	34.8	9.4	124
BXRC-40H1000-C-7x-SE	4000	97	360	1559	1372	34.8	12.5	124
BXRC-40H1000-D-7x-SE	4000	97	350	1133	997	26.0	9.1	124
BXRC-40A1001-B-73-SE ^{8,9}	4000	93	270	1267	1115	34.8	9.4	135
BXRC-40A1001-C-73-SE ^{8,9}	4000	93	360	1689	1486	34.8	12.5	135
BXRC-40A1001-D-73-SE ^{8,9}	4000	93	350	1227	1080	26.0	9.1	135
BXRC-50C1001-B-7x-SE	5000	70	270	1630	1434	34.8	9.4	173
BXRC-50C1001-C-7x-SE	5000	70	360	2173	1913	34.8	12.5	173
BXRC-50C1001-D-7x-SE	5000	70	350	1579	1389	26.0	9.1	173
BXRC-50E1001-B-7x-SE	5000	80	270	1568	1380	34.8	9.4	167
BXRC-50E1001-C-7x-SE	5000	80	360	2091	1840	34.8	12.5	167
BXRC-50E1001-D-7x-SE	5000	80	350	1519	1336	26.0	9.1	167
BXRC-50G1001-B-7x-SE	5000	90	270	1355	1193	34.8	9.4	144
BXRC-50G1001-C-7x-SE	5000	90	360	1807	1590	34.8	12.5	144
BXRC-50G1001-D-7x-SE	5000	90	350	1313	1155	26.0	9.1	144

Notes for Table 1:

- Nominal CCT as defined by ANSI C78.377-2011. Products with a CCT of 5000K-6500K are hot targeted to $T_c = 85^\circ\text{C}$.
- CRI values are typical for Decor Series Ultra, Decor Series Street and Landmark and Decor Series Class A products. CRI values are minimums for all other products. Minimum R_g value for 80 CRI products is 0, the minimum R_g values for 90 CRI products is 50, the minimum R_g values for 97 CRI products is 93. Bridgelux maintains a ± 3 tolerance on CRI and R_g values.
- Drive current is referred to as nominal drive current.
- Products tested under pulsed condition (10ms pulse width) at nominal test current where T_j (junction temperature) - T_c (case temperature) = 25°C .
- Typical performance values are provided as a reference only and are not a guarantee of performance.
- Bridgelux maintains a $\pm 7\%$ tolerance on flux measurements.
- Minimum flux values at the nominal test current are guaranteed by 100% test.
- Nominal CCT is defined by the Lighting Research Center's Class A definition. The center of the Class A color bin is on the corresponding isothermal line.
- GAI value is 80. To help ensure optimal fixture level performance, GAI is measured at the fixture level, on axis, at a case temperature of 70°C . GAI may vary depending on fixture design and performance.

Product Selection Guide

Table 1: Selection Guide, Pulsed Measurement Data ($T_j = T_c = 25^\circ\text{C}$) (continued)

Part Number	Nominal CCT ¹ (K)	CRI ²	Nominal Drive Current ³ (mA)	Typical Pulsed Flux ^{4,5,6} $T_c = 25^\circ\text{C}$ (lm)	Minimum Pulsed Flux ^{6,7} $T_c = 25^\circ\text{C}$ (lm)	Typical V_f (V)	Typical Power (W)	Typical Efficacy (lm/W)
BXRC-57C1001-B-7x-SE	5700	70	270	1586	1395	34.8	9.4	169
BXRC-57C1001-C-7x-SE	5700	70	360	2114	1861	34.8	12.5	169
BXRC-57C1001-D-7x-SE	5700	70	350	1536	1351	26.0	9.1	169
BXRC-57E1001-B-7x-SE	5700	80	270	1506	1325	34.8	9.4	160
BXRC-57E1001-C-7x-SE	5700	80	360	2008	1767	34.8	12.5	160
BXRC-57E1001-D-7x-SE	5700	80	350	1459	1284	26.0	9.1	160
BXRC-65C1001-B-7x-SE	6500	70	270	1586	1395	34.8	9.4	169
BXRC-65C1001-C-7x-SE	6500	70	360	2114	1861	34.8	12.5	169
BXRC-65C1001-D-7x-SE	6500	70	350	1536	1351	26.0	9.1	169
BXRC-65E1001-B-7x-SE	6500	80	270	1524	1341	34.8	9.4	162
BXRC-65E1001-C-7x-SE	6500	80	360	2032	1788	34.8	12.5	162
BXRC-65E1001-D-7x-SE	6500	80	350	1476	1299	26.0	9.1	162

Notes for Table 1:

- Nominal CCT as defined by ANSI C78.377-2011. Products with a CCT of 5000K-6500K are hot targeted to $T_c = 85^\circ\text{C}$.
- CRI values are typical for Decor Series Ultra, Decor Series Street and Landmark and Decor Series Class A products. CRI values are minimums for all other products. Minimum Rg value for 80 CRI products is 0, the minimum Rg values for 90 CRI products is 50, the minimum Rg values for 97 CRI products is 93. Bridgelux maintains a ± 3 tolerance on CRI and Rg values.
- Drive current is referred to as nominal drive current.
- Products tested under pulsed condition (10ms pulse width) at nominal test current where T_j (junction temperature) - T_c (case temperature) = 25°C .
- Typical performance values are provided as a reference only and are not a guarantee of performance.
- Bridgelux maintains a $\pm 7\%$ tolerance on flux measurements.
- Minimum flux values at the nominal test current are guaranteed by 100% test.
- Nominal CCT is defined by the Lighting Research Center's Class A definition. The center of the Class A color bin is on the corresponding isothermal line.
- GAI value is 80. To help ensure optimal fixture level performance, GAI is measured at the fixture level, on axis, at a case temperature of 70°C . GAI may vary depending on fixture design and performance.

Product Selection Guide

Table 2: Selection Guide, Stabilized DC Performance ($T_c = 70^\circ\text{C}$) ^{7,8}

Part Number	Nominal CCT ¹ (K)	GAI ²	CRI ³	Nominal Drive Current ⁴ (mA)	Typical DC Flux ^{5,6} $T_c = 70^\circ\text{C}$ (lm)	Minimum DC Flux ^{6,9} $T_c = 70^\circ\text{C}$ (lm)	Typical V_f (V)	Typical Power (W)	Typical Efficacy (lm/W)
BXRC-30A1001-B-73	3000	80	93	270	1022	899	34.3	9.3	110
BXRC-30A1001-C-73	3000	80	93	360	1362	1199	34.3	12.3	110
BXRC-30A1001-D-73	3000	80	93	350	989	871	25.5	8.9	111
BXRC-35A1001-B-73	3500	80	93	270	1088	957	34.3	9.3	117
BXRC-35A1001-C-73	3500	80	93	360	1450	1276	34.3	12.3	117
BXRC-35A1001-D-73	3500	80	93	350	1053	927	25.5	8.9	118
BXRC-40A1001-B-73	4000	80	93	270	1178	1037	34.3	9.3	127
BXRC-40A1001-C-73	4000	80	93	360	1571	1382	34.3	12.3	127
BXRC-40A1001-D-73	4000	80	93	350	1141	1004	25.5	8.9	128

Notes for Table 2:

- Nominal CCT is defined by the Lighting Research Center's Class A definition. The center of the Class A color bin is on the corresponding isothermal line.
- To help ensure optimal fixture level performance, GAI is measured at the fixture level, on axis, at a case temperature of 70°C . GAI may vary depending on fixture design and performance.
- CRI Values are specified as typical.
- Drive current is referred to as nominal drive current.
- Typical performance values are provided as a reference only and are not a guarantee of performance.
- Bridgelux maintains a $\pm 7\%$ tolerance on flux measurements.
- Typical stabilized DC performance values are provided as reference only and are not a guarantee of performance.
- Typical performance is estimated based on operation under DC (direct current) with LED array mounted onto a heat sink with thermal interface material and the case temperature maintained at specified temperature. Based on Bridgelux test setup, values may vary depending on the thermal design of the luminaire and/or the exposed environment to which the product is subjected.
- Minimum flux values at elevated temperatures are provided for reference only and are not guaranteed by 100% production testing. Based on Bridgelux test setup, values may vary depending on the thermal design of the luminaire and/or the exposed environment to which the product is subjected.

Product Selection Guide

Table 3: Selection Guide, Stabilized DC Performance ($T_c = 85^\circ\text{C}$)^{4,5}

Part Number	Nominal CCT ¹ (K)	CRI ²	Nominal Drive Current ³ (mA)	Typical DC Flux ^{4,5} $T_c = 85^\circ\text{C}$ (lm)	Minimum DC Flux ⁶ $T_c = 85^\circ\text{C}$ (lm)	Typical V_f (V)	Typical Power (W)	Typical Efficacy (lm/W)
BXRC-20B1001-B-73-SE	2000	65	270	1252	1102	33.8	9.1	137
BXRC-20B1001-D-73-SE	2000	65	350	1212	1067	25.3	8.9	137
BXRC-27E1000-B-7x-SE	2700	80	270	1276	1123	33.8	9.1	140
BXRC-27E1000-C-7x-SE	2700	80	360	1701	1497	33.8	12.2	140
BXRC-27E1000-D-7x-SE	2700	80	350	1235	1087	25.3	8.9	140
BXRC-27G10H0-B-7x-SE	2700	90	270	1092	961	33.8	9.1	120
BXRC-27G10H0-C-7x-SE	2700	90	360	1456	1282	33.8	12.2	120
BXRC-27G10H0-D-7x-SE	2700	90	350	1058	931	25.3	8.9	120
BXRC-27G1000-B-7x-SE	2700	90	270	1052	926	33.8	9.1	115
BXRC-27G1000-C-7x-SE	2700	90	360	1403	1235	33.8	12.2	115
BXRC-27G1000-D-7x-SE	2700	90	350	1019	897	25.3	8.9	115
BXRC-27H1000-B-7x-SE	2700	97	270	933	821	33.8	9.1	102
BXRC-27H1000-C-7x-SE	2700	97	360	1244	1095	33.8	12.2	102
BXRC-27H1000-D-7x-SE	2700	97	350	903	795	25.3	8.9	102
BXRC-30C1001-B-74-SE	3000	70	270	1419	1249	33.8	9.1	155
BXRC-30C1001-C-74-SE	3000	70	360	1892	1665	33.8	12.2	155
BXRC-30C1001-D-74-SE	3000	70	350	1374	1210	25.3	8.9	155
BXRC-30E1000-B-7x-SE	3000	80	270	1355	1193	33.8	9.1	148
BXRC-30E1000-C-7x-SE	3000	80	360	1807	1590	33.8	12.2	148
BXRC-30E1000-D-7x-SE	3000	80	350	1313	1155	25.3	8.9	148
BXRC-30G10H0-B-7x-SE	3000	90	270	1148	1010	33.8	9.1	126
BXRC-30G10H0-C-7x-SE	3000	90	360	1531	1347	33.8	12.2	126
BXRC-30G10H0-D-7x-SE	3000	90	350	1112	979	25.3	8.9	126
BXRC-30G1000-B-7x-SE	3000	90	270	1100	968	33.8	9.1	120
BXRC-30G1000-C-7x-SE	3000	90	360	1467	1291	33.8	12.2	120
BXRC-30G1000-D-7x-SE	3000	90	350	1066	938	25.3	8.9	120
BXRC-30G100C-B-73-SE	3000	90	270	1060	933	34.0	9.2	115
BXRC-30G100C-D-73-SE	3000	90	350	1027	904	25.3	8.9	116
BXRC-30H1000-B-7x-SE	3000	97	270	997	877	33.8	9.1	109
BXRC-30H1000-C-7x-SE	3000	97	360	1329	1169	33.8	12.2	109
BXRC-30H1000-D-7x-SE	3000	97	350	965	849	25.3	8.9	109
BXRC-30A1001-B-73-SE ^{7,8}	3000	93	270	989	870	33.8	9.1	108
BXRC-30A1001-C-73-SE ^{7,8}	3000	93	360	1318	1160	33.8	12.2	108
BXRC-30A1001-D-73-SE ^{7,8}	3000	93	350	958	843	25.3	8.9	108

Notes for Table 3:

- Nominal CCT as defined by ANSI C78.377-2011. Products with a CCT of 5000K-6500K are hot targeted to $T_c = 85^\circ\text{C}$.
- All CRI values are measured at $T_j = T_c = 25^\circ\text{C}$. CRI values are typical for Decor Series Ultra, Decor Series Street and Landmark and Decor Series Class A products. CRI values are minimums for all other products. Minimum Rg value for 80 CRI products is 0, the minimum Rg values for 90 CRI products is 50, the minimum Rg values for 97 CRI products is 93. Bridgelux maintains a ± 3 tolerance on CRI and Rg values.
- Drive current is referred to as nominal drive current.
- Typical stabilized DC performance values are provided as reference only and are not a guarantee of performance.
- Typical performance is estimated based on operation under DC (direct current) with LED array mounted onto a heat sink with thermal interface material and the case temperature maintained at 85°C . Based on Bridgelux test setup, values may vary depending on the thermal design of the luminaire and/or the exposed environment to which the product is subjected.
- Minimum flux values at elevated temperatures are provided for reference only and are not guaranteed by 100% production testing. Based on Bridgelux test setup, values may vary depending on the thermal design of the luminaire and/or the exposed environment to which the product is subjected.
- Nominal CCT is defined by the Lighting Research Center's Class A definition. The center of the Class A color bin is on the corresponding isothermal line.
- GAI value is 80. To help ensure optimal fixture level performance, GAI is measured at the fixture level, on axis, at a case temperature of 70°C . GAI may vary depending on fixture design and performance.

Product Selection Guide

Table 3: Selection Guide, Stabilized DC Performance ($T_c = 85^\circ\text{C}$)^{4,5} (continued)

Part Number	Nominal CCT ¹ (K)	CRI ²	Nominal Drive Current ³ (mA)	Typical DC Flux ^{4,5} $T_c = 85^\circ\text{C}$ (lm)	Minimum DC Flux ⁶ $T_c = 85^\circ\text{C}$ (lm)	Typical V_f (V)	Typical Power (W)	Typical Efficacy (lm/W)
BXRC-35E1000-B-7x-SE	3500	80	270	1387	1221	33.8	9.1	152
BXRC-35E1000-C-7x-SE	3500	80	360	1850	1628	33.8	12.2	152
BXRC-35E1000-D-7x-SE	3500	80	350	1344	1182	25.3	8.9	152
BXRC-35G1000-B-7x-SE	3500	90	270	1140	1003	33.8	9.1	125
BXRC-35G1000-C-7x-SE	3500	90	360	1520	1338	33.8	12.2	125
BXRC-35G1000-D-7x-SE	3500	90	350	1104	972	25.3	8.9	125
BXRC-35A1001-B-73-SE ^{7,8}	3500	93	270	1052	926	33.8	9.1	115
BXRC-35A1001-C-73-SE ^{7,8}	3500	93	360	1403	1235	33.8	12.2	115
BXRC-35A1001-D-73-SE ^{7,8}	3500	93	350	1019	897	25.3	8.9	115
BXRC-40C1001-B-74-SE	4000	70	270	1459	1284	33.8	9.1	160
BXRC-40C1001-C-74-SE	4000	70	360	1945	1712	33.8	12.2	160
BXRC-40C1001-D-74-SE	4000	70	350	1413	1244	25.3	8.9	160
BXRC-40E1000-B-7x-SE	4000	80	270	1395	1228	33.8	9.1	153
BXRC-40E1000-C-7x-SE	4000	80	360	1860	1637	33.8	12.2	153
BXRC-40E1000-D-7x-SE	4000	80	350	1351	1189	25.3	8.9	153
BXRC-40G1000-B-7x-SE	4000	90	270	1164	1024	33.8	9.1	127
BXRC-40G1000-C-7x-SE	4000	90	360	1552	1366	33.8	12.2	127
BXRC-40G1000-D-7x-SE	4000	90	350	1127	992	25.3	8.9	127
BXRC-40H1000-B-7x-SE	4000	97	270	1052	926	33.8	9.1	115
BXRC-40H1000-C-7x-SE	4000	97	360	1403	1235	33.8	12.2	115
BXRC-40H1000-D-7x-SE	4000	97	350	1019	897	25.3	8.9	115
BXRC-40A1001-B-73-SE ^{7,8}	4000	93	270	1140	1003	33.8	9.1	125
BXRC-40A1001-C-73-SE ^{7,8}	4000	93	360	1520	1338	33.8	12.2	125
BXRC-40A1001-D-73-SE ^{7,8}	4000	93	350	1104	972	25.3	8.9	125
BXRC-50C1001-B-7x-SE	5000	70	270	1467	1291	33.8	9.1	161
BXRC-50C1001-C-7x-SE	5000	70	360	1956	1721	33.8	12.2	161
BXRC-50C1001-D-7x-SE	5000	70	350	1421	1250	25.3	8.9	161
BXRC-50E1001-B-7x-SE	5000	80	270	1411	1242	33.8	9.1	154
BXRC-50E1001-C-7x-SE	5000	80	360	1882	1656	33.8	12.2	154
BXRC-50E1001-D-7x-SE	5000	80	350	1367	1203	25.3	8.9	154
BXRC-50G1001-B-7x-SE	5000	90	270	1220	1073	33.8	9.1	134
BXRC-50G1001-C-7x-SE	5000	90	360	1626	1431	33.8	12.2	134
BXRC-50G1001-D-7x-SE	5000	90	350	1181	1040	25.3	8.9	133

Notes for Table 3:

- Nominal CCT as defined by ANSI C78.377-2011. Products with a CCT of 5000K-6500K are hot targeted to $T_c = 85^\circ\text{C}$.
- All CRI values are measured at $T_s = T_c = 25^\circ\text{C}$. CRI values are typical for Decor Series Ultra, Decor Series Street and Landmark and Decor Series Class A products. CRI values are minimums for all other products. Minimum R_g value for 80 CRI products is 0, the minimum R_g values for 90 CRI products is 50, the minimum R_g values for 97 CRI products is 93. Bridgelux maintains a ± 3 tolerance on CRI and R_g values.
- Drive current is referred to as nominal drive current.
- Typical stabilized DC performance values are provided as reference only and are not a guarantee of performance.
- Typical performance is estimated based on operation under DC (direct current) with LED array mounted onto a heat sink with thermal interface material and the case temperature maintained at 85°C . Based on Bridgelux test setup, values may vary depending on the thermal design of the luminaire and/or the exposed environment to which the product is subjected.
- Minimum flux values at elevated temperatures are provided for reference only and are not guaranteed by 100% production testing. Based on Bridgelux test setup, values may vary depending on the thermal design of the luminaire and/or the exposed environment to which the product is subjected.
- Nominal CCT is defined by the Lighting Research Center's Class A definition. The center of the Class A color bin is on the corresponding isothermal line.
- GAI value is 80. To help ensure optimal fixture level performance, GAI is measured at the fixture level, on axis, at a case temperature of 70°C . GAI may vary depending on fixture design and performance.

Product Selection Guide

Table 3: Selection Guide, Stabilized DC Performance ($T_c = 85^\circ\text{C}$)^{4,5} (continued)

Part Number	Nominal CCT ¹ (K)	CRI ²	Nominal Drive Current ³ (mA)	Typical DC Flux ^{4,5} $T_c = 85^\circ\text{C}$ (lm)	Minimum DC Flux ⁶ $T_c = 85^\circ\text{C}$ (lm)	Typical V_f (V)	Typical Power (W)	Typical Efficacy (lm/W)
BXRC-57C1001-B-7x-SE	5700	70	270	1427	1256	33.8	9.1	156
BXRC-57C1001-C-7x-SE	5700	70	360	1903	1675	33.8	12.2	156
BXRC-57C1001-D-7x-SE	5700	70	350	1382	1216	25.3	8.9	156
BXRC-57E1001-B-7x-SE	5700	80	270	1355	1193	33.8	9.1	148
BXRC-57E1001-C-7x-SE	5700	80	360	1807	1590	33.8	12.2	148
BXRC-57E1001-D-7x-SE	5700	80	350	1313	1155	25.3	8.9	148
BXRC-65C1001-B-7x-SE	6500	70	270	1427	1256	33.8	9.1	156
BXRC-65C1001-C-7x-SE	6500	70	360	1903	1675	33.8	12.2	156
BXRC-65C1001-D-7x-SE	6500	70	350	1382	1216	25.3	8.9	156
BXRC-65E1001-B-7x-SE	6500	80	270	1371	1207	33.8	9.1	150
BXRC-65E1001-C-7x-SE	6500	80	360	1828	1609	33.8	12.2	150
BXRC-65E1001-D-7x-SE	6500	80	350	1328	1169	25.3	8.9	150

Notes for Table 3:

- Nominal CCT as defined by ANSI C78.377-2011. Products with a CCT of 5000K-6500K are hot targeted to $T_c = 85^\circ\text{C}$.
- All CRI values are measured at $T_c = T_a = 25^\circ\text{C}$. CRI values are typical for Decor Series Ultra, Decor Series Street and Landmark and Decor Series Class A products. CRI values are minimums for all other products. Minimum Rg value for 80 CRI products is 0, the minimum Rg values for 90 CRI products is 50, the minimum Rg values for 97 CRI products is 93. Bridgelux maintains a ± 3 tolerance on CRI and Rg values.
- Drive current is referred to as nominal drive current.
- Typical stabilized DC performance values are provided as reference only and are not a guarantee of performance.
- Typical performance is estimated based on operation under DC (direct current) with LED array mounted onto a heat sink with thermal interface material and the case temperature maintained at 85°C . Based on Bridgelux test setup, values may vary depending on the thermal design of the luminaire and/or the exposed environment to which the product is subjected.
- Minimum flux values at elevated temperatures are provided for reference only and are not guaranteed by 100% production testing. Based on Bridgelux test setup, values may vary depending on the thermal design of the luminaire and/or the exposed environment to which the product is subjected.
- Nominal CCT is defined by the Lighting Research Center's Class A definition. The center of the Class A color bin is on the corresponding isothermal line.
- GAI value is 80. To help ensure optimal fixture level performance, GAI is measured at the fixture level, on axis, at a case temperature of 70°C . GAI may vary depending on fixture design and performance.

European Product Registry for Energy Labeling

The European Product Registry for Energy Labeling (EPREL) is defined in the EU Regulation 2017/1369 to provide important energy efficiency information to consumers. Together with Energy Labeling Regulation ELR (EU) 2019/2015 which was amended by regulation (EU) 2021/340 for energy labelling of light sources, manufacturers are required to declare an energy class based on key technical specifications from each of their product and register it in an open data base managed by EPREL. It is now a legal requirement for a vendor of light sources to upload information about their products into the EPREL database before placing these products on the market in the EU.

Table 4 below provides a list of part numbers that are in compliance with ELR and are currently listed in the EPREL database.

At Bridgelux, we are fully committed to supplying products that are compliant with pertinent laws, rules, and obligation imposed by relevant government bodies including the European Energy Labeling regulation. Customers can use these products with full confidence for any projects that fall under the ELR.

Table 4: Part numbers registered in European Product Registry for Energy Labeling

PART NUMBER ¹	CCT (K)	CRI	Current ² (mA)	Vf (V)	Useful flux ³ (Φ_{use}) at 85C (lm)	Power (W)	Efficacy (lm/W)	Energy efficiency class ⁴	Registration No	URL to Product Information Sheet in EPREL Database
BXRC-20B1001-B-7x-SE	2000	65	540	35.1	1995	19.0	105	F	872440	https://eprelec.europa.eu/qr/872440
BXRC-20B1001-D-7x-SE	2000	65	700	27.7	1954	19.4	101	F	872442	https://eprelec.europa.eu/qr/872442
BXRC-27E1000-B-7x-SE	2700	80	540	35.1	2033	19.0	107	F	872459	https://eprelec.europa.eu/qr/872459
BXRC-27E1000-C-7x-SE	2700	80	720	35.1	2708	25.3	107	F	872464	https://eprelec.europa.eu/qr/872464
BXRC-27E1000-D-7x-SE	2700	80	700	27.7	1991	19.4	103	F	872469	https://eprelec.europa.eu/qr/872469
BXRC-27G10H0-B-7x-SE	2700	90	540	35.1	1741	19.0	92	G	872537	https://eprelec.europa.eu/qr/872537
BXRC-27G10H0-C-7x-SE	2700	90	720	35.1	2319	25.3	92	G	872541	https://eprelec.europa.eu/qr/872541
BXRC-27G10H0-D-7x-SE	2700	90	700	27.7	1705	19.4	88	G	872545	https://eprelec.europa.eu/qr/872545
BXRC-27G1000-B-7x-SE	2700	90	540	35.1	1677	19.0	88	G	872521	https://eprelec.europa.eu/qr/872521
BXRC-27G1000-C-7x-SE	2700	90	720	35.1	2234	25.3	88	G	872526	https://eprelec.europa.eu/qr/872526
BXRC-27G1000-D-7x-SE	2700	90	700	27.7	1643	19.4	85	G	872531	https://eprelec.europa.eu/qr/872531
BXRC-27H1000-B-7x-SE	2700	95	540	35.1	1487	19.0	78	G	872630	https://eprelec.europa.eu/qr/872630
BXRC-27H1000-C-7x-SE	2700	95	720	35.1	1980	25.3	78	G	872634	https://eprelec.europa.eu/qr/872634
BXRC-27H1000-D-7x-SE	2700	95	700	27.7	1456	19.4	75	G	872638	https://eprelec.europa.eu/qr/872638
BXRC-30C1001-B-7x-SE	3000	70	540	35.1	2262	19.0	119	E	872693	https://eprelec.europa.eu/qr/872693
BXRC-30C1001-C-7x-SE	3000	70	720	35.1	3012	25.3	119	E	872699	https://eprelec.europa.eu/qr/872699
BXRC-30C1001-D-7x-SE	3000	70	700	27.7	2215	19.4	114	F	872705	https://eprelec.europa.eu/qr/872705

Notes for Table 4:

1. All device listed here must be disposed as e-waste upon its end of life according to local country guideline in each country.
2. For information on performance values at alternative drive conditions, please refer to the Product Selection Guide, Absolute Maximum Rating Table and Performance Curves in this data sheet.
3. For a definition of useful luminous flux (Φ_{use}), please see the ELR regulations at <https://tinyurl.com/4b6zvt4m>.
4. EPREL requires an arrow symbol containing the letter of the energy efficiency class to be displayed, on technical promotional material. Refer to this energy efficiency class column for specific energy efficiency class on each part number.

European Product Registry for Energy Labeling

Table 4: Part numbers registered in European Product Registry for Energy Labeling (Continued)

PART NUMBER ¹	CCT (K)	CRI	Current ² (mA)	Vf (V)	Useful flux ³ (Φ_{use}) at 85°C (lm)	Power (W)	Efficacy (lm/W)	Energy efficiency class ⁴	Registration No	URL to Product Information Sheet in EPREL Database
BXRC-30E1000-B-7x-SE	3000	80	540	35.1	2160	19.0	114	F	872765	https://eprelec.europa.eu/qr/872765
BXRC-30E1000-C-7x-SE	3000	80	720	35.1	2877	25.3	114	F	872770	https://eprelec.europa.eu/qr/872770
BXRC-30E1000-D-7x-SE	3000	80	700	27.7	2116	19.4	109	F	872775	https://eprelec.europa.eu/qr/872775
BXRC-30G10H0-B-7x-SE	3000	90	540	35.1	1830	19.0	96	F	872847	https://eprelec.europa.eu/qr/872847
BXRC-30G10H0-C-7x-SE	3000	90	720	35.1	2437	25.3	96	F	872851	https://eprelec.europa.eu/qr/872851
BXRC-30G10H0-D-7x-SE	3000	90	700	27.7	1792	19.4	92	F	872855	https://eprelec.europa.eu/qr/872855
BXRC-30G1000-B-7x-SE	3000	90	540	35.1	1754	19.0	92	F	872827	https://eprelec.europa.eu/qr/872827
BXRC-30G1000-C-7x-SE	3000	90	720	35.1	2336	25.3	92	F	872832	https://eprelec.europa.eu/qr/872832
BXRC-30G1000-D-7x-SE	3000	90	700	27.7	1717	19.4	89	G	872837	https://eprelec.europa.eu/qr/872837
BXRC-30G100C-B-7x-SE	3000	90	540	35.1	1754	19.0	92	F	872843	https://eprelec.europa.eu/qr/872843
BXRC-30G100C-D-7x-SE	3000	90	700	27.7	1717	19.4	89	G	872845	https://eprelec.europa.eu/qr/872845
BXRC-30H1000-B-7x-SE	3000	95	540	35.1	1589	19.0	84	G	872953	https://eprelec.europa.eu/qr/872953
BXRC-30H1000-C-7x-SE	3000	95	720	35.1	2116	25.3	84	G	872957	https://eprelec.europa.eu/qr/872957
BXRC-30H1000-D-7x-SE	3000	95	700	27.7	1556	19.4	80	G	872961	https://eprelec.europa.eu/qr/872961
BXRC-30A1001-B-7x-SE	3000	90	540	35.1	1576	19.0	83	G	872679	https://eprelec.europa.eu/qr/872679
BXRC-30A1001-C-7x-SE	3000	90	720	35.1	2099	25.3	83	G	872680	https://eprelec.europa.eu/qr/872680
BXRC-30A1001-D-7x-SE	3000	90	700	27.7	1543	19.4	80	G	872681	https://eprelec.europa.eu/qr/872681
BXRC-35E1000-B-7x-SE	3500	80	540	35.1	2211	19.0	117	F	873012	https://eprelec.europa.eu/qr/873012
BXRC-35E1000-C-7x-SE	3500	80	720	35.1	2945	25.3	116	F	873017	https://eprelec.europa.eu/qr/873017
BXRC-35E1000-D-7x-SE	3500	80	700	27.7	2165	19.4	112	F	873022	https://eprelec.europa.eu/qr/873022
BXRC-35G1000-B-7x-SE	3500	90	540	35.1	1817	19.0	96	F	873074	https://eprelec.europa.eu/qr/873074
BXRC-35G1000-C-7x-SE	3500	90	720	35.1	2420	25.3	96	F	873079	https://eprelec.europa.eu/qr/873079
BXRC-35G1000-D-7x-SE	3500	90	700	27.7	1780	19.4	92	F	873084	https://eprelec.europa.eu/qr/873084
BXRC-35A1001-B-7x-SE	3500	90	540	35.1	1677	19.0	88	G	872998	https://eprelec.europa.eu/qr/872998
BXRC-35A1001-C-7x-SE	3500	90	720	35.1	2234	25.3	88	G	872999	https://eprelec.europa.eu/qr/872999
BXRC-35A1001-D-7x-SE	3500	90	700	27.7	1643	19.4	85	G	873000	https://eprelec.europa.eu/qr/873000
BXRC-40C1001-B-7x-SE	4000	70	540	35.1	2326	19.0	123	E	873156	https://eprelec.europa.eu/qr/873156
BXRC-40C1001-C-7x-SE	4000	70	720	35.1	3097	25.3	122	E	873162	https://eprelec.europa.eu/qr/873162
BXRC-40C1001-D-7x-SE	4000	70	700	27.7	2277	19.4	117	F	873168	https://eprelec.europa.eu/qr/873168
BXRC-40E1000-B-7x-SE	4000	80	540	35.1	2224	19.0	117	F	873228	https://eprelec.europa.eu/qr/873228
BXRC-40E1000-C-7x-SE	4000	80	720	35.1	2962	25.3	117	F	873233	https://eprelec.europa.eu/qr/873233
BXRC-40E1000-D-7x-SE	4000	80	700	27.7	2178	19.4	112	F	873238	https://eprelec.europa.eu/qr/873238
BXRC-40G1000-B-7x-SE	4000	90	540	35.1	1855	19.0	98	F	873290	https://eprelec.europa.eu/qr/873290
BXRC-40G1000-C-7x-SE	4000	90	720	35.1	2471	25.3	98	F	873295	https://eprelec.europa.eu/qr/873295
BXRC-40G1000-D-7x-SE	4000	90	700	27.7	1817	19.4	94	F	873300	https://eprelec.europa.eu/qr/873300

Notes for Table 4:

- All device listed here must be disposed as e-waste upon its end of life according to local country guideline in each country.
- For information on performance values at alternative drive conditions, please refer to the Product Selection Guide, Absolute Maximum Rating Table and Performance Curves in this data sheet.
- For a definition of useful luminous flux (Φ_{use}), please see the ELR regulations at <https://tinyurl.com/4b6zvt4m>.
- EPREL requires an arrow symbol containing the letter of the energy efficiency class to be displayed, on technical promotional material. Refer to this energy efficiency class column for specific energy efficiency class on each part number.

European Product Registry for Energy Labeling

Table 4: Part numbers registered in European Product Registry for Energy Labeling (Continued)

PART NUMBER ¹	CCT (K)	CRI	Current ² (mA)	Vf (V)	Useful flux ³ (Φ_{use}) at 85C (lm)	Power (W)	Efficacy (lm/W)	Energy efficiency class ⁴ 	Registration No	URL to Product Information Sheet in EPREL Database
BXRC-40H1000-B-7X-SE	4000	95	540	35.1	1677	19.0	88	G	873351	https://eprelec.europa.eu/qr/873351
BXRC-40H1000-C-7X-SE	4000	95	720	35.1	2234	25.3	88	G	873353	https://eprelec.europa.eu/qr/873353
BXRC-40H1000-D-7X-SE	4000	95	700	27.7	1643	19.4	85	G	873355	https://eprelec.europa.eu/qr/873355
BXRC-40A1001-B-7X-SE	4000	90	540	35.1	1817	19.0	96	F	873142	https://eprelec.europa.eu/qr/873142
BXRC-40A1001-C-7X-SE	4000	90	720	35.1	2420	25.3	96	F	873143	https://eprelec.europa.eu/qr/873143
BXRC-40A1001-D-7X-SE	4000	90	700	27.7	1780	19.4	92	F	873144	https://eprelec.europa.eu/qr/873144
BXRC-50C1001-B-7X-SE	5000	70	540	35.1	2338	19.0	123	E	873372	https://eprelec.europa.eu/qr/873372
BXRC-50C1001-C-7X-SE	5000	70	720	35.1	3114	25.3	123	E	873376	https://eprelec.europa.eu/qr/873376
BXRC-50C1001-D-7X-SE	5000	70	700	27.7	2290	19.4	118	F	873380	https://eprelec.europa.eu/qr/873380
BXRC-50E1001-B-7X-SE	5000	80	540	35.1	2249	19.0	119	F	873420	https://eprelec.europa.eu/qr/873420
BXRC-50E1001-C-7X-SE	5000	80	720	35.1	2996	25.3	118	F	873424	https://eprelec.europa.eu/qr/873424
BXRC-50E1001-D-7X-SE	5000	80	700	27.7	2203	19.4	114	F	873428	https://eprelec.europa.eu/qr/873428
BXRC-50G1001-B-7X-SE	5000	90	540	35.1	1944	19.0	102	F	873468	https://eprelec.europa.eu/qr/873468
BXRC-50G1001-C-7X-SE	5000	90	720	35.1	2589	25.3	102	F	873472	https://eprelec.europa.eu/qr/873472
BXRC-50G1001-D-7X-SE	5000	90	700	27.7	1904	19.4	98	F	873476	https://eprelec.europa.eu/qr/873476
BXRC-57C1001-B-7X-SE	5700	70	540	35.1	2275	19.0	120	E	873554	https://eprelec.europa.eu/qr/873554
BXRC-57C1001-C-7X-SE	5700	70	720	35.1	3029	25.3	120	E	873558	https://eprelec.europa.eu/qr/873558
BXRC-57C1001-D-7X-SE	5700	70	700	27.7	2228	19.4	115	F	873562	https://eprelec.europa.eu/qr/873562
BXRC-57E1001-B-7X-SE	5700	80	540	35.1	2160	19.0	114	F	873602	https://eprelec.europa.eu/qr/873602
BXRC-57E1001-C-7X-SE	5700	80	720	35.1	2877	25.3	114	F	873606	https://eprelec.europa.eu/qr/873606
BXRC-57E1001-D-7X-SE	5700	80	700	27.7	2116	19.4	109	F	873610	https://eprelec.europa.eu/qr/873610
BXRC-65C1001-B-7X-SE	6500	70	540	35.1	2275	19.0	120	E	873650	https://eprelec.europa.eu/qr/873650
BXRC-65C1001-C-7X-SE	6500	70	720	35.1	3029	25.3	120	E	873654	https://eprelec.europa.eu/qr/873654
BXRC-65C1001-D-7X-SE	6500	70	700	27.7	2228	19.4	115	F	873658	https://eprelec.europa.eu/qr/873658
BXRC-65E1001-B-7X-SE	6500	80	540	35.1	2186	19.0	115	F	873698	https://eprelec.europa.eu/qr/873698
BXRC-65E1001-C-7X-SE	6500	80	720	35.1	2911	25.3	115	F	873702	https://eprelec.europa.eu/qr/873702
BXRC-65E1001-D-7X-SE	6500	80	700	27.7	2140	19.4	110	F	873706	https://eprelec.europa.eu/qr/873706

Notes for Table 4:

1. All device listed here must be disposed as e-waste upon its end of life according to local country guideline in each country.
2. For information on performance values at alternative drive conditions, please refer to the Product Selection Guide, Absolute Maximum Rating Table and Performance Curves in this data sheet.
3. For a definition of useful luminous flux (Φ_{use}), please see the ELR regulations at <https://tinyurl.com/4b6zvt4m>.
4. EPREL requires an arrow symbol containing the letter of the energy efficiency class to be displayed, on technical promotional material. Refer to this energy efficiency class column for specific energy efficiency class on each part number.

Performance at Commonly Used Drive Currents

Vero SE LED arrays are tested to the specifications shown using the nominal drive currents in Table 1. Vero SE may also be driven at other drive currents dependent on specific application design requirements. The performance at any drive current can be derived from the current vs. voltage characteristics shown in Figures 1, 2 & 3 and the flux vs. current characteristics shown in Figures 4, 5 & 6. The performance at commonly used drive currents is summarized in Table 5.

Table 5: Product Performance at Commonly Used Drive Currents

Part Number	CRI	Drive Current ¹ (mA)	Typical V_f $T_c = 25^\circ\text{C}$ (V)	Typical Power $T_c = 25^\circ\text{C}$ (W)	Typical Flux ² $T_c = 25^\circ\text{C}$ (lm)	Typical DC Flux ³ $T_c = 85^\circ\text{C}$ (lm)	Typical Efficacy $T_c = 25^\circ\text{C}$ (lm/W)
BXRC-20B1001-B-7x-SE	65	135	33.1	4.5	728	660	163
		180	33.6	6.1	958	866	158
		270	34.8	9.4	1391	1252	148
		405	36.2	14.7	2007	1789	137
		540	37.5	20.3	2588	2282	128
BXRC-20B1001-D-73-SE	65	175	24.9	4.4	711	645	163
		233	25.4	5.9	936	847	158
		350	26.0	9.1	1347	1212	148
		525	27.4	14.4	1986	1770	138
		700	28.4	19.9	2534	2234	127
BXRC-27E1000-B-7x-SE	80	135	33.1	4.5	742	672	166
		180	33.6	6.1	976	883	161
		270	34.8	9.4	1417	1276	151
		405	36.2	14.7	2045	1823	139
		540	37.5	20.3	2637	2325	130
BXRC-27E1000-C-7x-SE	80	180	33.1	6.0	990	897	166
		240	33.6	8.1	1301	1177	161
		360	34.8	12.5	1890	1701	151
		540	36.2	19.5	2725	2429	139
		720	37.5	27.0	3512	3097	130
BXRC-27E1000-D-7x-SE	80	175	24.9	4.4	725	657	166
		233	25.4	5.9	954	863	161
		350	26.0	9.1	1373	1235	151
		525	27.4	14.4	2024	1804	141
		700	28.4	19.9	2582	2277	130
BXRC-27G10H0-B-7x-SE	90	135	33.1	4.5	635	576	142
		180	33.6	6.1	836	756	138
		270	34.8	9.4	1214	1355	129
		405	36.2	14.7	1751	1561	119
		540	37.5	20.3	2258	1991	111
BXRC-27G10H0-C-7x-SE	90	180	33.1	6.0	847	768	142
		240	33.6	8.1	1114	1008	138
		360	34.8	12.5	1618	1807	129
		540	36.2	19.5	2333	2080	119
		720	37.5	27.0	3007	2651	111
BXRC-27G10H0-D-7x-SE	90	175	24.9	4.4	620	563	142
		233	25.4	5.9	817	739	138
		350	26.0	9.1	1175	1313	129
		525	27.4	14.4	1733	1545	121
		700	28.4	19.9	2211	1950	111

Notes for Table 5:

1. Alternate drive currents are provided for reference only and are not a guarantee of performance.
2. Bridgelux maintains a $\pm 7\%$ tolerance on flux measurements.
3. Typical stabilized DC performance values are provided as reference only and are not a guarantee of performance.

Performance at Commonly Used Drive Currents

Table 5: Product Performance at Commonly Used Drive Currents (Continued)

Part Number	CRI	Drive Current ¹ (mA)	Typical V_f $T_c = 25^\circ\text{C}$ (V)	Typical Power $T_c = 25^\circ\text{C}$ (W)	Typical Flux ² $T_c = 25^\circ\text{C}$ (lm)	Typical DC Flux ³ $T_c = 85^\circ\text{C}$ (lm)	Typical Efficacy $T_c = 25^\circ\text{C}$ (lm/W)
BXRC-27G1000-B-7x-SE	90	135	33.1	4.5	612	555	137
		180	33.6	6.1	805	728	133
		270	34.8	9.4	1169	1052	124
		405	36.2	14.7	1687	1504	115
		540	37.5	20.3	2176	1918	107
BXRC-27G1000-C-7x-SE	90	180	33.1	6.0	817	740	137
		240	33.6	8.1	1073	971	133
		360	34.8	12.5	1559	1403	124
		540	36.2	19.5	2248	2004	115
		720	37.5	27.0	2897	2555	107
BXRC-27G1000-D-7x-SE	90	175	24.9	4.4	598	542	137
		233	25.4	5.9	787	712	133
		350	26.0	9.1	1133	1019	124
		525	27.4	14.4	1669	1488	116
		700	28.4	19.9	2130	1878	107
BXRC-27H1000-B-7x-SE	97	135	33.1	4.5	542	492	121
		180	33.6	6.1	714	646	118
		270	34.8	9.4	1036	933	110
		405	36.2	14.7	1496	1333	102
		540	37.5	20.3	1928	1700	95
BXRC-27H1000-C-7x-SE	97	180	33.1	6.0	724	656	121
		240	33.6	8.1	952	861	118
		360	34.8	12.5	1382	1244	110
		540	36.2	19.5	1992	1776	102
		720	37.5	27.0	2568	2264	95
BXRC-27H1000-D-7x-SE	97	175	24.9	4.4	530	480	121
		233	25.4	5.9	698	631	118
		350	26.0	9.1	1004	903	110
		525	27.4	14.4	1480	1319	103
		700	28.4	19.9	1888	1665	95
BXRC-30C1001-B-7x-SE	70	135	33.1	4.5	825	748	185
		180	33.6	6.1	1086	982	179
		270	34.8	9.4	1577	1419	168
		405	36.2	14.7	2275	2028	155
		540	37.5	20.3	2934	2587	145
BXRC-30C1001-C-7x-SE	70	180	33.1	6.0	1101	998	185
		240	33.6	8.1	1448	1309	179
		360	34.8	12.5	2103	1892	168
		540	36.2	19.5	3031	2702	155
		720	37.5	27.0	3907	3445	145
BXRC-30C1001-D-7x-SE	70	175	24.9	4.4	806	731	185
		233	25.4	5.9	1061	960	179
		350	26.0	9.1	1527	1374	168
		525	27.4	14.4	2251	2007	157
		700	28.4	19.9	2873	2533	144

Notes for Table 5:

1. Alternate drive currents are provided for reference only and are not a guarantee of performance.
2. Bridgelux maintains a $\pm 7\%$ tolerance on flux measurements.
3. Typical stabilized DC performance values are provided as reference only and are not a guarantee of performance.

Performance at Commonly Used Drive Currents

Table 5: Product Performance at Commonly Used Drive Currents (Continued)

Part Number	CRI	Drive Current ¹ (mA)	Typical V _f T _c = 25°C (V)	Typical Power T _c = 25°C (W)	Typical Flux ² T _c = 25°C (lm)	Typical DC Flux ³ T _c = 85°C (lm)	Typical Efficacy T _c = 25°C (lm/W)
BXRC-30E1000-B-7x-SE	80	135	33.1	4.5	788	714	177
		180	33.6	6.1	1037	938	171
		270	34.8	9.4	1506	1355	160
		405	36.2	14.7	2173	1937	148
		540	37.5	20.3	2802	2470	138
BXRC-30E1000-C-7x-SE	80	180	33.1	6.0	1052	953	177
		240	33.6	8.1	1383	1250	171
		360	34.8	12.5	2008	1807	160
		540	36.2	19.5	2895	2581	148
BXRC-30E1000-D-7x-SE	80	720	37.5	27.0	3732	3290	138
		175	24.9	4.4	770	698	177
		233	25.4	5.9	1014	917	171
		350	26.0	9.1	1459	1313	160
BXRC-30E1000-D-7x-SE	80	525	27.4	14.4	2150	1917	150
		700	28.4	19.9	2744	2419	138
		135	33.1	4.5	667	605	150
		180	33.6	6.1	878	795	145
BXRC-30G10H0-B-7x-SE	90	270	34.8	9.4	1276	1148	136
		405	36.2	14.7	1841	1641	125
		540	37.5	20.3	2373	2093	117
		180	33.1	6.0	891	808	150
		240	33.6	8.1	1171	1059	145
BXRC-30G10H0-C-7x-SE	90	360	34.8	12.5	1701	1531	136
		540	36.2	19.5	2452	2186	125
		720	37.5	27.0	3161	2787	117
		175	24.9	4.4	652	591	150
BXRC-30G10H0-D-7x-SE	90	233	25.4	5.9	859	777	145
		350	26.0	9.1	1235	1112	136
		525	27.4	14.4	1821	1623	127
		700	28.4	19.9	2324	2049	117
BXRC-30G1000-B-7x-SE	90	135	33.1	4.5	640	580	143
		180	33.6	6.1	842	761	139
		270	34.8	9.4	1223	1100	130
		405	36.2	14.7	1764	1573	120
		540	37.5	20.3	2275	2005	112
BXRC-30G1000-C-7x-SE	90	180	33.1	6.0	854	774	143
		240	33.6	8.1	1122	1015	139
		360	34.8	12.5	1630	1467	130
		540	36.2	19.5	2350	2095	120
BXRC-30G1000-D-7x-SE	90	720	37.5	27.0	3029	2671	112
		175	24.9	4.4	625	567	143
		233	25.4	5.9	823	744	139
		350	26.0	9.1	1184	1066	130
BXRC-30G1000-D-7x-SE	90	525	27.4	14.4	1745	1556	121
		700	28.4	19.9	2227	1964	112

Notes for Table 5:

1. Alternate drive currents are provided for reference only and are not a guarantee of performance.
2. Bridgelux maintains a ± 7% tolerance on flux measurements.
3. Typical stabilized DC performance values are provided as reference only and are not a guarantee of performance.

Performance at Commonly Used Drive Currents

Table 5: Product Performance at Commonly Used Drive Currents (Continued)

Part Number	CRI	Drive Current ¹ (mA)	Typical V _f T _c = 25°C (V)	Typical Power T _c = 25°C (W)	Typical Flux ² T _c = 25°C (lm)	Typical DC Flux ³ T _c = 85°C (lm)	Typical Efficacy T _c = 25°C (lm/W)
BXRC-30G100C-B-7x-SE	90	135	33.1	4.5	616	559	138
		180	33.6	6.1	811	734	134
		270	34.8	9.4	1178	1060	125
		405	36.2	14.7	1700	1516	116
		540	37.5	20.3	2192	1933	108
BXRC-30G100C-D-7x-SE	90	175	24.9	4.4	602	546	138
		233	25.4	5.9	793	717	134
		350	26.0	9.1	1141	1027	125
		525	27.4	14.4	1682	1499	117
		700	28.4	19.9	2147	1893	108
BXRC-30H1000-B-7x-SE	97	135	33.1	4.5	579	525	130
		180	33.6	6.1	763	690	126
		270	34.8	9.4	1107	997	118
		405	36.2	14.7	1598	1425	109
		540	37.5	20.3	2060	1817	102
BXRC-30H1000-C-7x-SE	97	180	33.1	6.0	773	701	130
		240	33.6	8.1	1017	919	126
		360	34.8	12.5	1476	1329	118
		540	36.2	19.5	2129	1898	109
		720	37.5	27.0	2744	2419	102
BXRC-30H1000-D-7x-SE	97	175	24.9	4.4	566	513	130
		233	25.4	5.9	745	674	126
		350	26.0	9.1	1072	965	118
		525	27.4	14.4	1581	1409	110
		700	28.4	19.9	2017	1779	101
BXRC-30A1001-B-7x-SE	93	135	33.1	4.5	575	521	129
		180	33.6	6.1	756	684	125
		270	34.8	9.4	1099	989	117
		405	36.2	14.7	1585	1413	108
		540	37.5	20.3	2044	1802	101
BXRC-30A1001-C-7x-SE	93	180	33.1	6.0	767	695	129
		240	33.6	8.1	1008	912	125
		360	34.8	12.5	1465	1318	117
		540	36.2	19.5	2112	1882	108
		720	37.5	27.0	2722	2400	101
BXRC-30A1001-D-7x-SE	93	175	24.9	4.4	562	509	129
		233	25.4	5.9	739	669	125
		350	26.0	9.1	1064	958	117
		525	27.4	14.4	1568	1398	109
		700	28.4	19.9	2001	1765	101
BXRC-35E1000-B-7x-SE	80	135	33.1	4.5	806	731	181
		180	33.6	6.1	1061	960	175
		270	34.8	9.4	1541	1387	164
		405	36.2	14.7	2224	1983	152
		540	37.5	20.3	2868	2529	141

Notes for Table 5:

1. Alternate drive currents are provided for reference only and are not a guarantee of performance.
2. Bridgelux maintains a ± 7% tolerance on flux measurements.
3. Typical stabilized DC performance values are provided as reference only and are not a guarantee of performance.

Performance at Commonly Used Drive Currents

Table 5: Product Performance at Commonly Used Drive Currents (Continued)

Part Number	CRI	Drive Current ¹ (mA)	Typical V _f T _c = 25°C (V)	Typical Power T _c = 25°C (W)	Typical Flux ² T _c = 25°C (lm)	Typical DC Flux ³ T _c = 85°C (lm)	Typical Efficacy T _c = 25°C (lm/W)
BXRC-35E1000-C-7x-SE	80	180	33.1	6.0	1076	976	181
		240	33.6	8.1	1415	1280	175
		360	34.8	12.5	2055	1850	164
		540	36.2	19.5	2963	2642	152
		720	37.5	27.0	3819	3367	141
BXRC-35E1000-D-7x-SE	80	175	24.9	4.4	788	714	181
		233	25.4	5.9	1037	938	175
		350	26.0	9.1	1493	1344	164
		525	27.4	14.4	2201	1962	153
		700	28.4	19.9	2808	2476	141
BXRC-35G1000-B-7x-SE	90	135	33.1	4.5	663	601	148
		180	33.6	6.1	872	789	144
		270	34.8	9.4	1267	1140	135
		405	36.2	14.7	1828	1630	125
		540	37.5	20.3	2357	2078	116
BXRC-35G1000-C-7x-SE	90	180	33.1	6.0	885	802	148
		240	33.6	8.1	1163	1052	144
		360	34.8	12.5	1689	1520	135
		540	36.2	19.5	2435	2171	125
		720	37.5	27.0	3139	2768	116
BXRC-35G1000-D-7x-SE	90	175	24.9	4.4	648	587	148
		233	25.4	5.9	853	771	144
		350	26.0	9.1	1227	1104	135
		525	27.4	14.4	1809	1612	126
		700	28.4	19.9	2308	2035	116
BXRC-35A1001-B-73-SE	93	135	33.1	4.5	612	555	137
		180	33.6	6.1	805	728	133
		270	34.8	9.4	1169	1052	124
		405	36.2	14.7	1687	1504	115
		540	37.5	20.3	2176	1918	107
BXRC-35A1001-C-73-SE	93	180	33.1	6.0	817	740	137
		240	33.6	8.1	1073	971	133
		360	34.8	12.5	1559	1403	124
		540	36.2	19.5	2248	2004	115
		720	37.5	27.0	2897	2555	107
BXRC-35A1001-D-73-SE	93	175	24.9	4.4	598	542	137
		233	25.4	5.9	787	712	133
		350	26.0	9.1	1133	1019	124
		525	27.4	14.4	1669	1488	116
		700	28.4	19.9	2130	1878	107
BXRC-40C1001-B-7x-SE	70	135	33.1	4.5	848	769	190
		180	33.6	6.1	1116	1010	184
		270	34.8	9.4	1621	1459	173
		405	36.2	14.7	2339	2085	159
		540	37.5	20.3	3016	2659	149

Notes for Table 5:

1. Alternate drive currents are provided for reference only and are not a guarantee of performance.
2. Bridgelux maintains a ± 7% tolerance on flux measurements.
3. Typical stabilized DC performance values are provided as reference only and are not a guarantee of performance.

Performance at Commonly Used Drive Currents

Table 5: Product Performance at Commonly Used Drive Currents (Continued)

Part Number	CRI	Drive Current ¹ (mA)	Typical V_f $T_c = 25^\circ\text{C}$ (V)	Typical Power $T_c = 25^\circ\text{C}$ (W)	Typical Flux ² $T_c = 25^\circ\text{C}$ (lm)	Typical DC Flux ³ $T_c = 85^\circ\text{C}$ (lm)	Typical Efficacy $T_c = 25^\circ\text{C}$ (lm/W)
BXRC-40C1001-C-7X-SE	70	180	33.1	6.0	1132	1026	190
		240	33.6	8.1	1488	1346	184
		360	34.8	12.5	2162	1945	173
		540	36.2	19.5	3116	2778	159
BXRC-40C1001-D-7X-SE	70	720	37.5	27.0	4017	3542	149
		175	24.9	4.4	829	751	190
		233	25.4	5.9	1091	987	184
		350	26.0	9.1	1570	1413	173
BXRC-40E1000-B-7X-SE	80	525	27.4	14.4	2314	2063	161
		700	28.4	19.9	2954	2604	148
		135	33.1	4.5	811	735	182
		180	33.6	6.1	1068	966	176
BXRC-40E1000-C-7X-SE	70	270	34.8	9.4	1550	1395	165
		405	36.2	14.7	2237	1994	152
		540	37.5	20.3	2884	2543	142
		180	33.1	6.0	1083	981	182
BXRC-40E1000-D-7X-SE	70	240	33.6	8.1	1423	1287	176
		360	34.8	12.5	2067	1860	165
		540	36.2	19.5	2980	2657	152
		720	37.5	27.0	3841	3387	142
BXRC-40G1000-B-7X-SE	80	175	24.9	4.4	793	719	182
		233	25.4	5.9	1043	944	176
		350	26.0	9.1	1501	1351	165
		525	27.4	14.4	2213	1973	154
BXRC-40G1000-C-7X-SE	70	700	28.4	19.9	2824	2490	142
		135	33.1	4.5	677	613	152
		180	33.6	6.1	891	806	147
		270	34.8	9.4	1293	1164	138
BXRC-40G1000-D-7X-SE	80	405	36.2	14.7	1866	1664	127
		540	37.5	20.3	2406	2122	119
		180	33.1	6.0	903	819	152
		240	33.6	8.1	1187	1074	147
BXRC-40H1000-B-7X-SE	97	360	34.8	12.5	1725	1552	138
		540	36.2	19.5	2486	2216	127
		720	37.5	27.0	3205	2826	119
		175	24.9	4.4	661	599	152
BXRC-40H1000-D-7X-SE	80	233	25.4	5.9	871	787	147
		350	26.0	9.1	1253	1127	138
		525	27.4	14.4	1846	1646	128
		700	28.4	19.9	2356	2078	118
BXRC-40H1000-B-7X-SE	97	135	33.1	4.5	612	555	137
		180	33.6	6.1	805	728	133
		270	34.8	9.4	1169	1052	124
		405	36.2	14.7	1687	1504	115
BXRC-40H1000-B-7X-SE	97	540	37.5	20.3	2176	1918	107

Notes for Table 5:

1. Alternate drive currents are provided for reference only and are not a guarantee of performance.
2. Bridgelux maintains a $\pm 7\%$ tolerance on flux measurements.
3. Typical stabilized DC performance values are provided as reference only and are not a guarantee of performance.

Performance at Commonly Used Drive Currents

Table 5: Product Performance at Commonly Used Drive Currents (Continued)

Part Number	CRI	Drive Current ¹ (mA)	Typical V_f $T_c = 25^\circ\text{C}$ (V)	Typical Power $T_c = 25^\circ\text{C}$ (W)	Typical Flux ² $T_c = 25^\circ\text{C}$ (lm)	Typical DC Flux ³ $T_c = 85^\circ\text{C}$ (lm)	Typical Efficacy $T_c = 25^\circ\text{C}$ (lm/W)
BXRC-40H1000-C-7x-SE	97	180	33.1	6.0	817	740	137
		240	33.6	8.1	1073	971	133
		360	34.8	12.5	1559	1403	124
		540	36.2	19.5	2248	2004	115
BXRC-40H1000-D-7x-SE	97	720	37.5	27.0	2897	2555	107
		175	24.9	4.4	598	542	137
		233	25.4	5.9	787	712	133
		350	26.0	9.1	1133	1019	124
BXRC-40A1001-B-7x-SE	93	525	27.4	14.4	1669	1488	116
		700	28.4	19.9	2130	1878	107
		135	33.1	4.5	663	601	148
		180	33.6	6.1	872	789	144
BXRC-40A1001-C-7x-SE	93	270	34.8	9.4	1267	1140	135
		405	36.2	14.7	1828	1630	125
		540	37.5	20.3	2357	2078	116
		180	33.1	6.0	885	802	148
BXRC-40A1001-D-7x-SE	93	240	33.6	8.1	1163	1052	144
		350	26.0	9.1	1227	1104	135
		525	27.4	14.4	1809	1612	126
		700	28.4	19.9	2308	2035	116
BXRC-50C1001-B-7x-SE	70	135	33.1	4.5	853	773	191
		180	33.6	6.1	1122	1015	185
		270	34.8	9.4	1630	1467	173
		405	36.2	14.7	2352	2097	160
BXRC-50C1001-C-7x-SE	70	540	37.5	20.3	3033	2674	150
		180	33.1	6.0	1138	1032	191
		240	33.6	8.1	1496	1353	185
		360	34.8	12.5	2173	1956	173
BXRC-50C1001-D-7x-SE	70	540	36.2	19.5	3133	2793	160
		720	37.5	27.0	4039	3561	150
		175	24.9	4.4	833	755	191
		233	25.4	5.9	1097	992	185
BXRC-50E1001-B-7x-SE	80	350	26.0	9.1	1579	1421	173
		525	27.4	14.4	2327	2074	162
		700	28.4	19.9	2970	2618	149
		135	33.1	4.5	820	744	184
BXRC-50E1001-C-7x-SE	80	180	33.6	6.1	1080	977	178
		270	34.8	9.4	1568	1411	167
		405	36.2	14.7	2263	2017	154
		540	37.5	20.3	2917	2572	144

Notes for Table 5:

1. Alternate drive currents are provided for reference only and are not a guarantee of performance.
2. Bridgelux maintains a $\pm 7\%$ tolerance on flux measurements.
3. Typical stabilized DC performance values are provided as reference only and are not a guarantee of performance.

Performance at Commonly Used Drive Currents

Table 5: Product Performance at Commonly Used Drive Currents (Continued)

Part Number	CRI	Drive Current ¹ (mA)	Typical V_f $T_c = 25^\circ\text{C}$ (V)	Typical Power $T_c = 25^\circ\text{C}$ (W)	Typical Flux ² $T_c = 25^\circ\text{C}$ (lm)	Typical DC Flux ³ $T_c = 85^\circ\text{C}$ (lm)	Typical Efficacy $T_c = 25^\circ\text{C}$ (lm/W)
BXRC-50E1001-C-7x-SE	80	180	33.1	6.0	1095	993	184
		240	33.6	8.1	1439	1302	178
		360	34.8	12.5	2091	1882	167
		540	36.2	19.5	3014	2687	154
BXRC-50E1001-D-7x-SE	80	720	37.5	27.0	3885	3426	144
		175	24.9	4.4	802	727	184
		233	25.4	5.9	1055	955	178
		350	26.0	9.1	1519	1367	167
BXRC-50G1001-B-7x-SE	90	525	27.4	14.4	2239	1996	156
		700	28.4	19.9	2857	2519	144
		135	33.1	4.5	709	643	159
		180	33.6	6.1	933	844	154
BXRC-50G1001-C-7x-SE	90	270	34.8	9.4	1355	1220	144
		405	36.2	14.7	1956	1744	133
		540	37.5	20.3	2522	2223	124
		180	33.1	6.0	946	858	159
BXRC-50G1001-D-7x-SE	90	240	33.6	8.1	1244	1125	154
		350	26.0	9.1	1313	1181	144
		525	27.4	14.4	1935	1725	135
		700	28.4	19.9	2469	2177	124
BXRC-57C1001-B-7x-SE	70	135	33.1	4.5	830	752	186
		180	33.6	6.1	1092	988	180
		270	34.8	9.4	1586	1427	169
		405	36.2	14.7	2288	2040	156
BXRC-57C1001-C-7x-SE	70	540	37.5	20.3	2950	2601	146
		180	33.1	6.0	1107	1004	186
		240	33.6	8.1	1456	1317	180
		360	34.8	12.5	2114	1903	169
BXRC-57C1001-D-7x-SE	70	540	36.2	19.5	3048	2717	156
		720	37.5	27.0	3929	3464	146
		175	24.9	4.4	811	735	186
		233	25.4	5.9	1067	965	180
BXRC-57E1001-B-7x-SE	80	350	26.0	9.1	1536	1382	169
		525	27.4	14.4	2264	2018	158
		700	28.4	19.9	2889	2547	145
		135	33.1	4.5	788	714	177
BXRC-57E1001-C-7x-SE	80	180	33.6	6.1	1037	938	171
		270	34.8	9.4	1506	1355	160
		405	36.2	14.7	2173	1937	148
		540	37.5	20.3	2802	2470	138

Notes for Table 5:

1. Alternate drive currents are provided for reference only and are not a guarantee of performance.
2. Bridgelux maintains a $\pm 7\%$ tolerance on flux measurements.
3. Typical stabilized DC performance values are provided as reference only and are not a guarantee of performance.

Performance at Commonly Used Drive Currents

Table 5: Product Performance at Commonly Used Drive Currents (Continued)

Part Number	CRI	Drive Current ¹ (mA)	Typical V_f $T_c = 25^\circ\text{C}$ (V)	Typical Power $T_c = 25^\circ\text{C}$ (W)	Typical Flux ² $T_c = 25^\circ\text{C}$ (lm)	Typical DC Flux ³ $T_c = 85^\circ\text{C}$ (lm)	Typical Efficacy $T_c = 25^\circ\text{C}$ (lm/W)
BXRC-57E1001-C-7x-SE	80	180	33.1	6.0	1052	953	177
		240	33.6	8.1	1383	1250	171
		360	34.8	12.5	2008	1807	160
		540	36.2	19.5	2895	2581	148
		720	37.5	27.0	3732	3290	138
BXRC-57E1001-D-7x-SE	80	175	24.9	4.4	770	698	177
		233	25.4	5.9	1014	917	171
		350	26.0	9.1	1459	1313	160
		525	27.4	14.4	2150	1917	150
		700	28.4	19.9	2744	2419	138
BXRC-65C1001-B-7x-SE	70	135	33.1	4.5	830	752	186
		180	33.6	6.1	1092	988	180
		270	34.8	9.4	1586	1427	169
		405	36.2	14.7	2288	2040	156
		540	37.5	20.3	2950	2601	146
BXRC-65C1001-C-7x-SE	70	180	33.1	6.0	1107	1004	186
		240	33.6	8.1	1456	1317	180
		360	34.8	12.5	2114	1903	169
		540	36.2	19.5	3048	2717	156
		720	37.5	27.0	3929	3464	146
BXRC-65C1001-D-7x-SE	70	175	24.9	4.4	811	735	186
		233	25.4	5.9	1067	965	180
		350	26.0	9.1	1536	1382	169
		525	27.4	14.4	2264	2018	158
		700	28.4	19.9	2889	2547	145
BXRC-65E1001-B-7x-SE	80	135	33.1	4.5	797	723	179
		180	33.6	6.1	1049	949	173
		270	34.8	9.4	1524	1371	162
		405	36.2	14.7	2199	1960	150
		540	37.5	20.3	2835	2500	140
BXRC-65E1001-C-7x-SE	80	180	33.1	6.0	1064	965	179
		240	33.6	8.1	1399	1265	173
		360	34.8	12.5	2032	1828	162
		540	36.2	19.5	2929	2611	150
		720	37.5	27.0	3775	3329	140
BXRC-65E1001-D-7x-SE	80	175	24.9	4.4	779	706	179
		233	25.4	5.9	1026	928	173
		350	26.0	9.1	1476	1328	162
		525	27.4	14.4	2175	1939	151
		700	28.4	19.9	2776	2448	140

Notes for Table 5:

1. Alternate drive currents are provided for reference only and are not a guarantee of performance.
2. Bridgelux maintains a $\pm 7\%$ tolerance on flux measurements.
3. Typical stabilized DC performance values are provided as reference only and are not a guarantee of performance.

Electrical Characteristics

Table 6: Electrical Characteristics

Part Number	Drive Current (mA)	Forward Voltage Pulsed, $T_c = 25^\circ\text{C}$ (V) ^{1, 2, 3, 8}			Typical Coefficient of Forward Voltage ⁴ $\Delta V_f / \Delta T_c$ (mV/ $^\circ\text{C}$)	Typical Thermal Resistance Junction to Case ^{5,6} R_{j-c} ($^\circ\text{C}/\text{W}$)	Driver Selection Voltages ⁷ (V)	
		Minimum	Typical	Maximum			V_f Min. Hot $T_c = 105^\circ\text{C}$ (V)	V_f Max. Cold $T_c = -40^\circ\text{C}$ (V)
BXRC-xxx100x-B-7x-SE	270	32.2	34.8	37.4	-16.1	0.49	30.9	38.5
	540	34.7	37.5	40.3	-16.1	0.56	33.4	41.4
BXRC-xxx100x-C-7x-SE	360	32.2	34.8	37.4	-16.1	0.37	30.9	38.5
	720	34.7	37.5	40.3	-16.1	0.45	33.4	41.4
BXRC-xxx100x-D-7x-SE	350	24.1	26.0	28.0	-11.8	0.49	23.1	28.7
	700	26.3	28.4	30.5	-11.8	0.57	25.3	31.3

Notes for Table 6:

- Parts are tested in pulsed conditions, $T_c = 25^\circ\text{C}$. Pulse width is 10ms.
- Voltage minimum and maximum are provided for reference only and are not a guarantee of performance.
- Bridgelux maintains a tester tolerance of $\pm 0.10\text{V}$ on forward voltage measurements.
- Typical coefficient of forward voltage tolerance is $\pm 0.1\text{mV}$ for nominal current.
- Thermal resistance values are based from test data of a 3000K 80 CRI product.
- Thermal resistance value was calculated using total electrical input power; optical power was not subtracted from input power. The thermal interface material used during testing is not included in the thermal resistance value.
- V_f min hot and max cold values are provided as reference only and are not guaranteed by test. These values are provided to aid in driver design and selection over the operating range of the product.
- This product has been designed and manufactured per IEC 62031:2014. This product has passed dielectric withstand voltage testing at 1160 V. The working voltage designated for the insulation is 80V d.c. The maximum allowable voltage across the array must be determined in the end product application.

Eye Safety

Table 7: Eye Safety Risk Group (RG) Classifications

Part Number	Drive Current ⁵ (mA)	CCT ⁵			
		2700K/3000K	4000K ²	5000K ³	6500K ⁴
BXRC-xxx100x-B-7x-SE	270	RG1	RG1	RG1	RG1
	405	RG1	RG1	RG1	RG2
	540	RG1	RG1	RG2	RG2
BXRC-xxx100x-C-7x-SE	360	RG1	RG1	RG1	RG2
	540	RG1	RG1	RG2	RG2
	720	RG1	RG2	RG2	RG2
BXRC-xxx100x-D-7x-SE	350	RG1	RG1	RG1	RG1
	525	RG1	RG1	RG1	RG2
	700	RG1	RG1	RG2	RG2

Notes for Table 7:

1. Eye safety classification for the use of Bridgelux Vero SE Series LED arrays is in accordance with specification IEC/TR 62778: Application of IEC 62471 for the assessment of blue light hazard to light sources and luminaires.
2. For products classified as RG2 at 4000K, $E_{thr} = 1847.5$ lx.
3. For products classified as RG2 at 5000K, $E_{thr} = 1315.8$ lx.
4. For products classified as RG2 at 6500K, $E_{thr} = 1124.5$ lx.
5. Please contact your Bridgelux sales representative for E_{thr} values at specific drive currents and CCTs not listed.

Absolute Maximum Ratings

Table 8: Maximum Ratings

Parameter	Maximum Rating		
LED Junction Temperature (T_j)	150°C		
Storage Temperature	-40°C to +105°C		
Operating Case Temperature ¹ (T_c)	105°C		
	BXRC-xxx100x-B-7x-SE	BXRC-xxx100x-C-7x-SE	BXRC-xxx100x-D-7x-SE
Maximum Drive Current ³	540mA	720mA	700mA
Maximum Peak Pulsed Drive Current ⁴	770mA	1030mA	1000mA
Maximum Reverse Voltage ⁵	-60V	-60V	-45V

Notes for Table 8:

1. For IEC 62717 requirement, please consult your Bridgelux sales representative.
2. Refer to Bridgelux Application Note AN120: Assembly Considerations for Bridgelux Vero SE LED Arrays.
3. Arrays may be driven at higher currents however lumen maintenance may be reduced.
4. Bridgelux recommends a maximum duty cycle of 10% and pulse width of 20 ms when operating LED Arrays at maximum peak pulsed current specified. Maximum peak pulsed currents indicate values where LED Arrays can be driven without catastrophic failures.
5. Light emitting diodes are not designed to be driven in reverse voltage and will not produce light under this condition. Maximum rating provided for reference only.

Performance Curves

Figure 1: Vero SE 10B Drive Current vs. Voltage

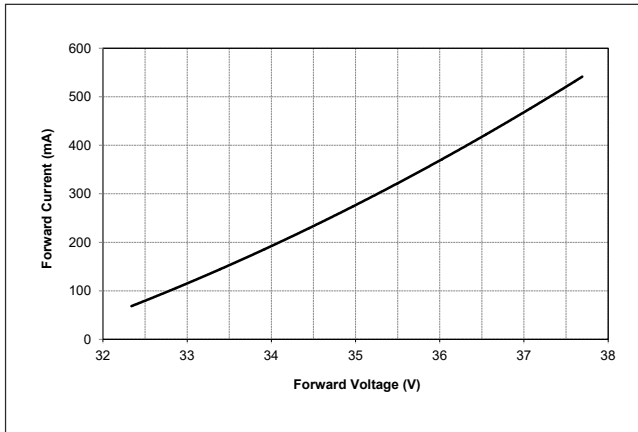

Figure 2: Vero SE 10C Drive Current vs. Voltage

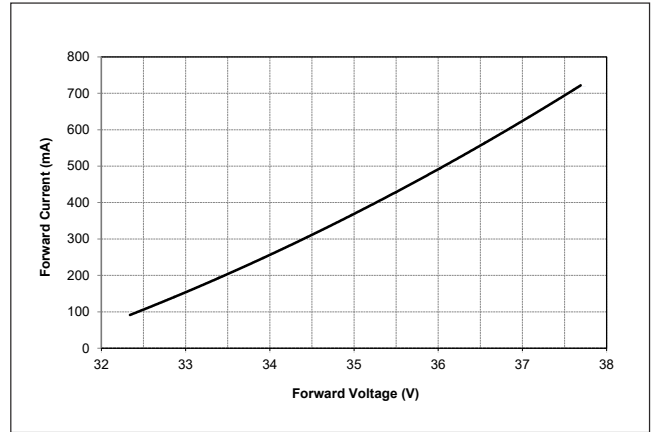

Figure 3: Vero SE 10D Drive Current vs. Voltage

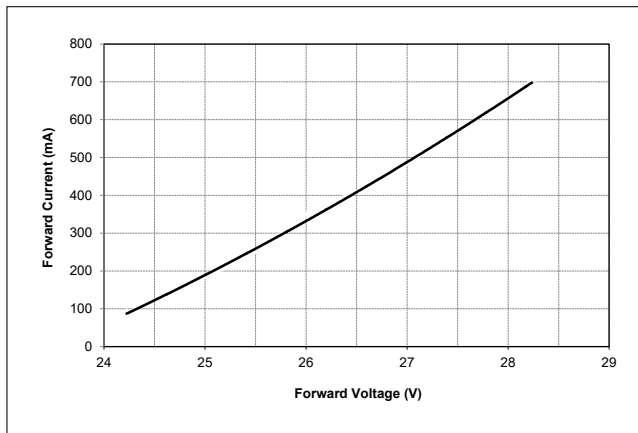

Figure 4: Vero 10B SE Typical Relative Flux vs. Current

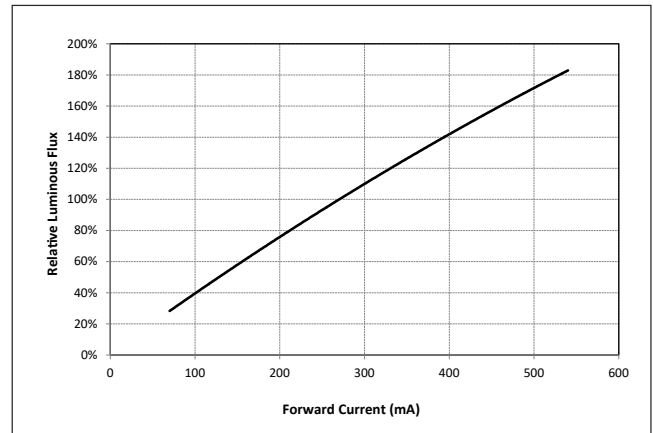

Figure 5: Vero 10C SE Typical Relative Flux vs. Current

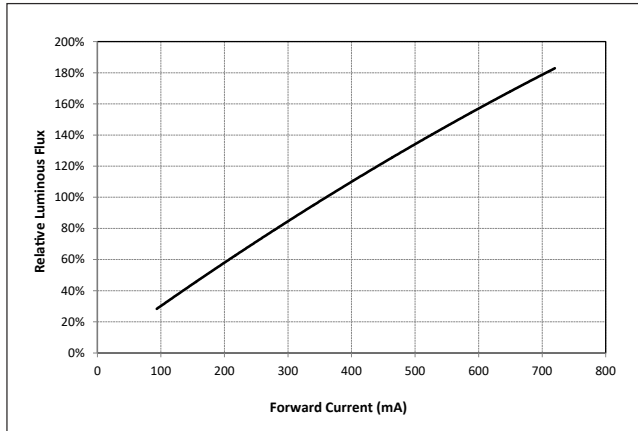
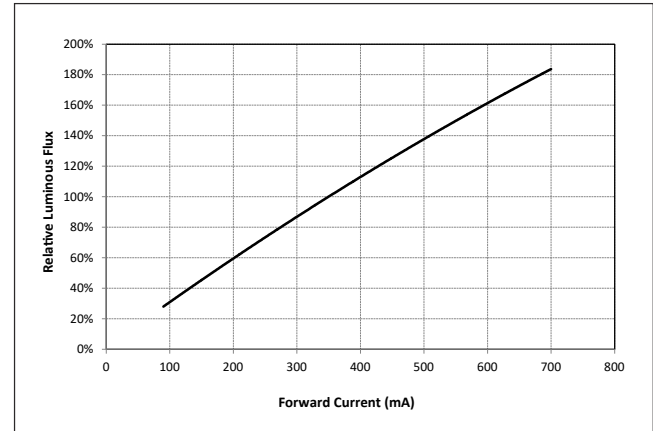

Figure 6 Vero 10D SE Typical Relative Flux vs. Current



Notes for Figure 1-6:

1. Bridgelux does not recommend driving high power LEDs at low currents. Doing so may produce unpredictable results. Pulse width modulation (PWM) is recommended for dimming effects.
2. Products tested under pulsed condition (10ms pulse width) at nominal test current where T_j (junction temperature) = T_c (case temperature) = 25°C.

Performance Curves

Figure 7: Typical DC Flux vs. Case Temperature

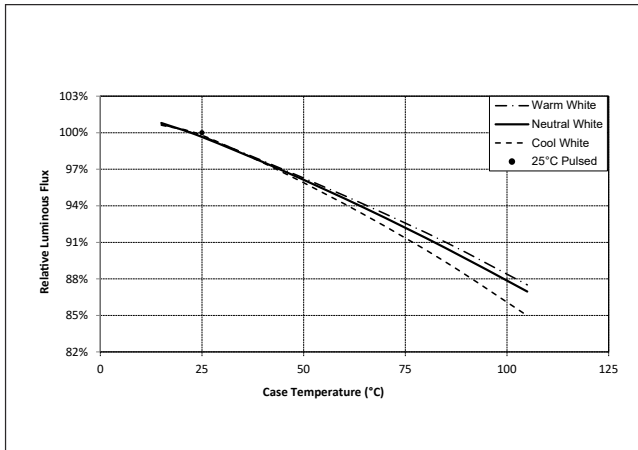

Figure 8: Typical DC ccy Shift vs. Case Temperature

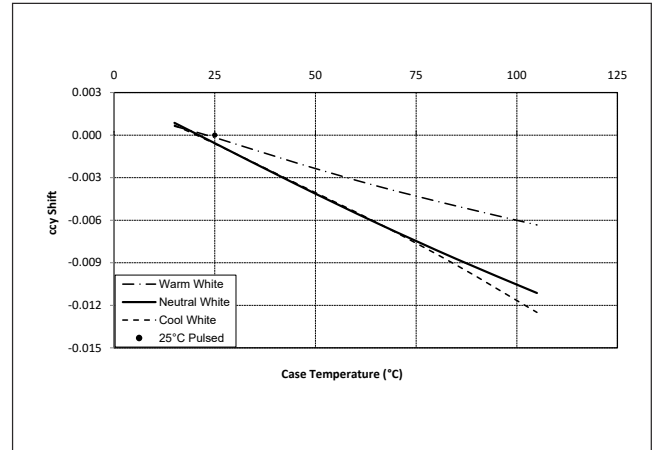

Figure 9: Typical DC ccx Shift vs. Case Temperature

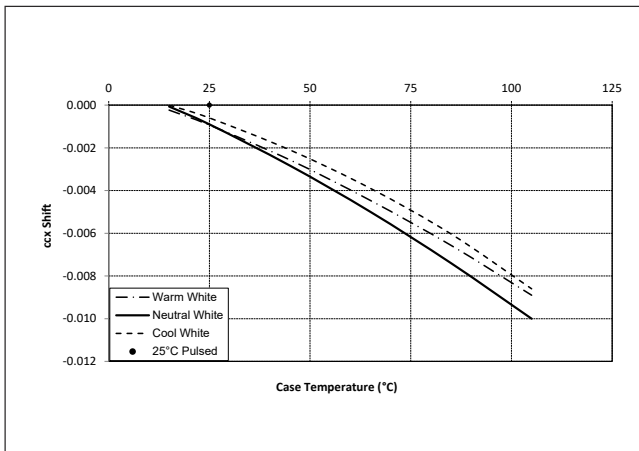
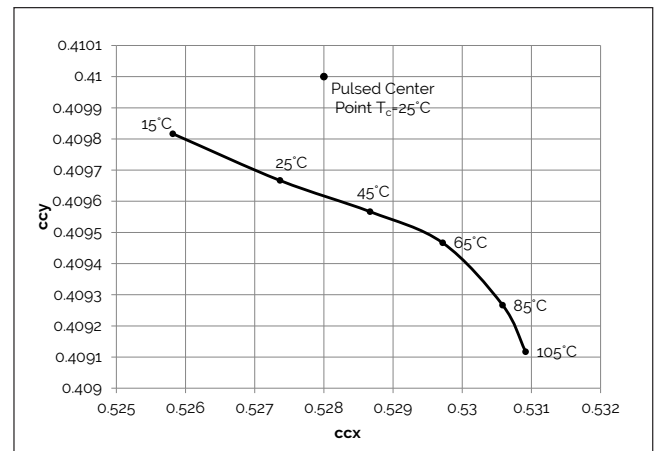

Figure 10: 2000K, 65 CRI Color Shift vs. Case Temperature



Notes for Figures 7 - 9:

1. Characteristics shown for warm white based on 3000K and 80 CRI.
2. Characteristics shown for neutral white based on 4000K and 80 CRI.
3. Characteristics shown for cool white based on 5000K and 70 CRI.
4. For other color SKUs, the shift in color will vary. Please contact your Bridgelux Sales Representative for more information.

Performance Curves

Figure 11: 2700K, 97 CRI Color Shift vs. Case Temperature¹

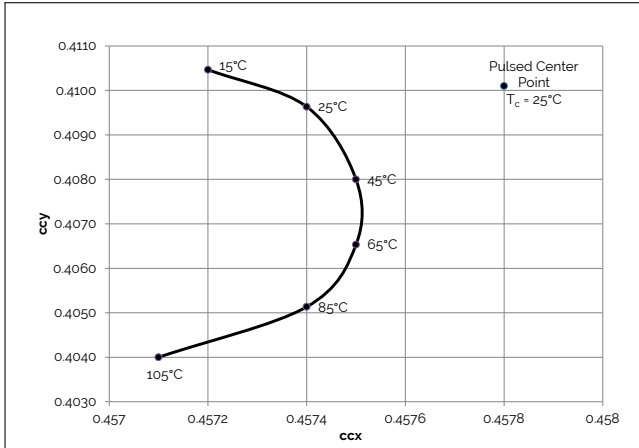

Figure 12: 3000K, 97 CRI Color Shift vs. Case Temperature¹

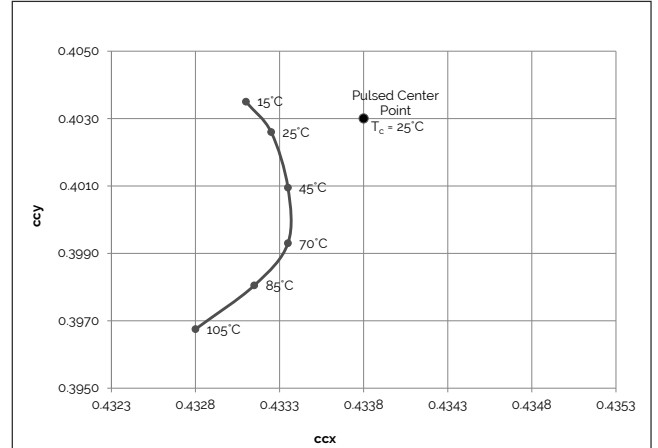

Figure 13: 3000K, 90 CRI Color Shift vs. Case Temperature^{1,3}

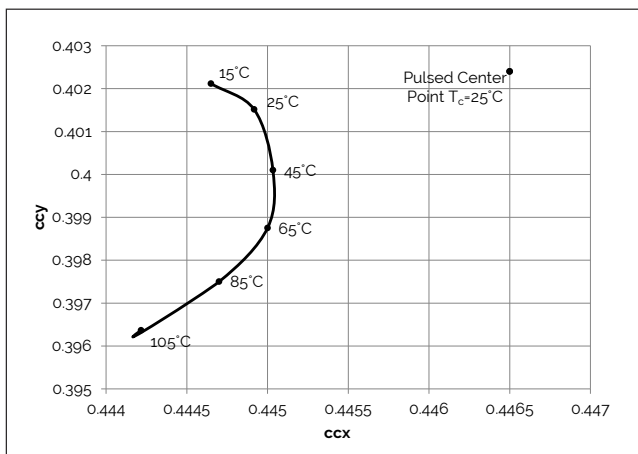

Figure 14: 3000K Class A Color Shift vs. Case Temperature¹

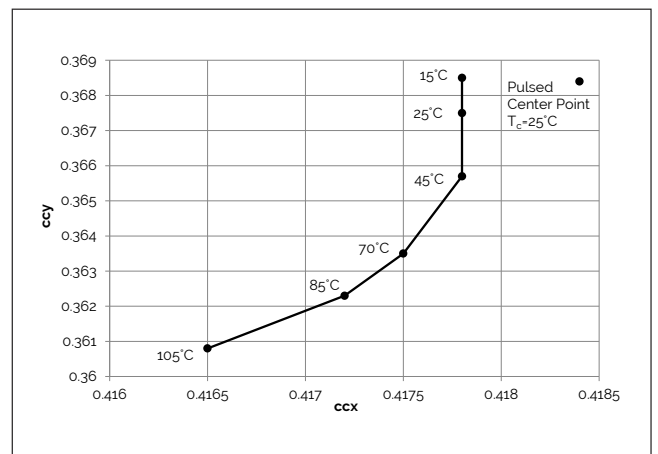

Figure 15: 3500K Class A Color Shift vs. Case Temperature¹

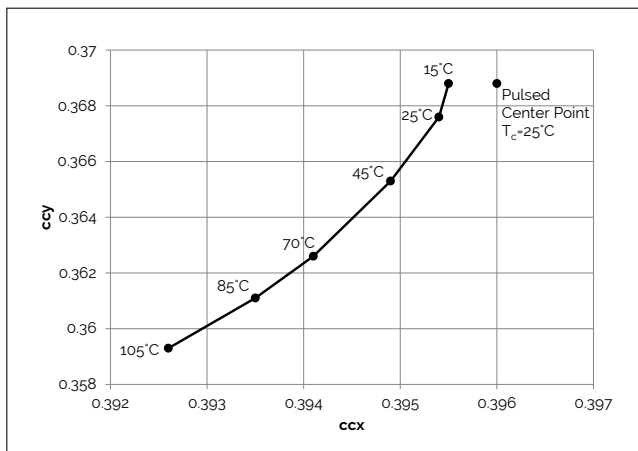
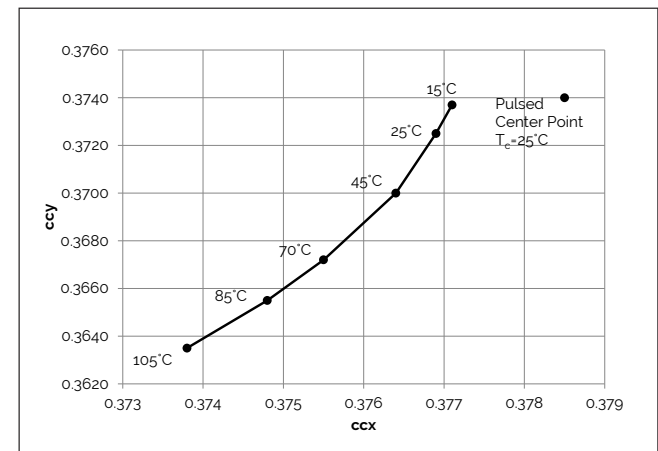

Figure 16: 4000K Class A Color Shift vs. Case Temperature¹



Notes for Figures 10-16:

1. Measurements made under DC test conditions at the nominal drive current.
2. Typical color shift is shown with a tolerance of ± 0.002 .
3. Characteristics shown for Decor Series Showcase products, BXRC-30G100C-x-73-SE

Typical Radiation Pattern

Figure 17: Typical Spatial Radiation Pattern

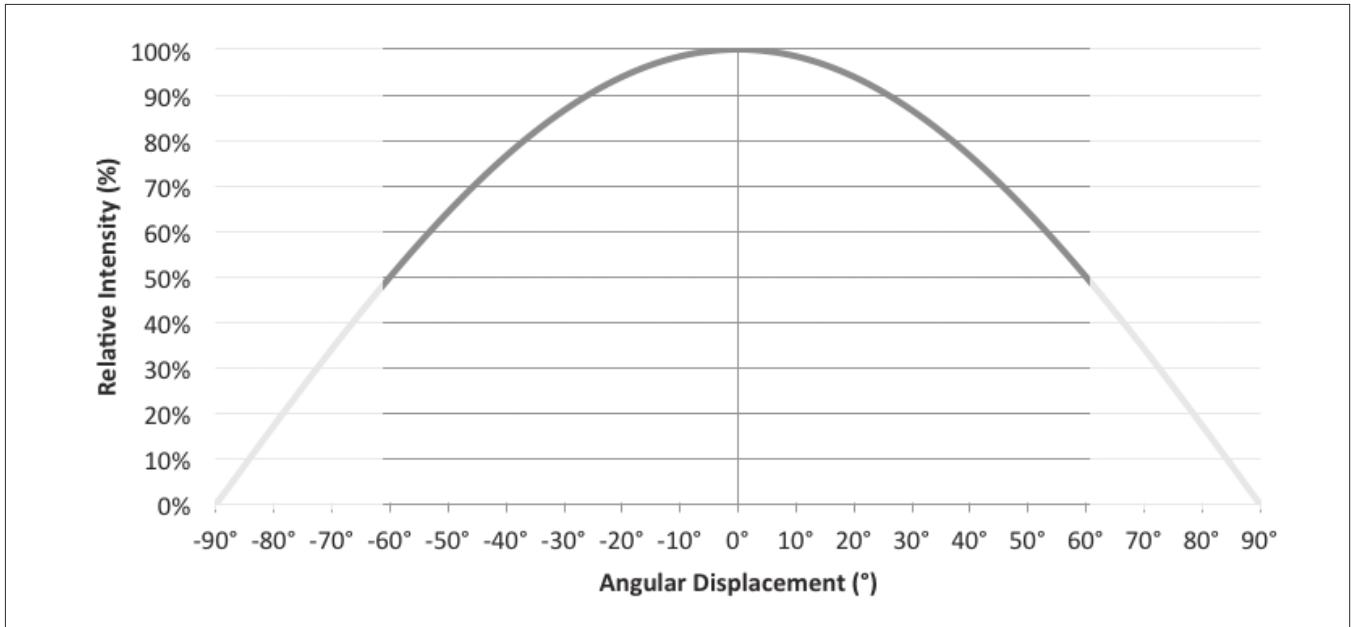

Notes for Figure 17:

1. Typical viewing angle is 120°.
2. The viewing angle is defined as the off axis angle from the centerline where intensity is ½ of the peak value.

Figure 18: Typical Polar Radiation Pattern

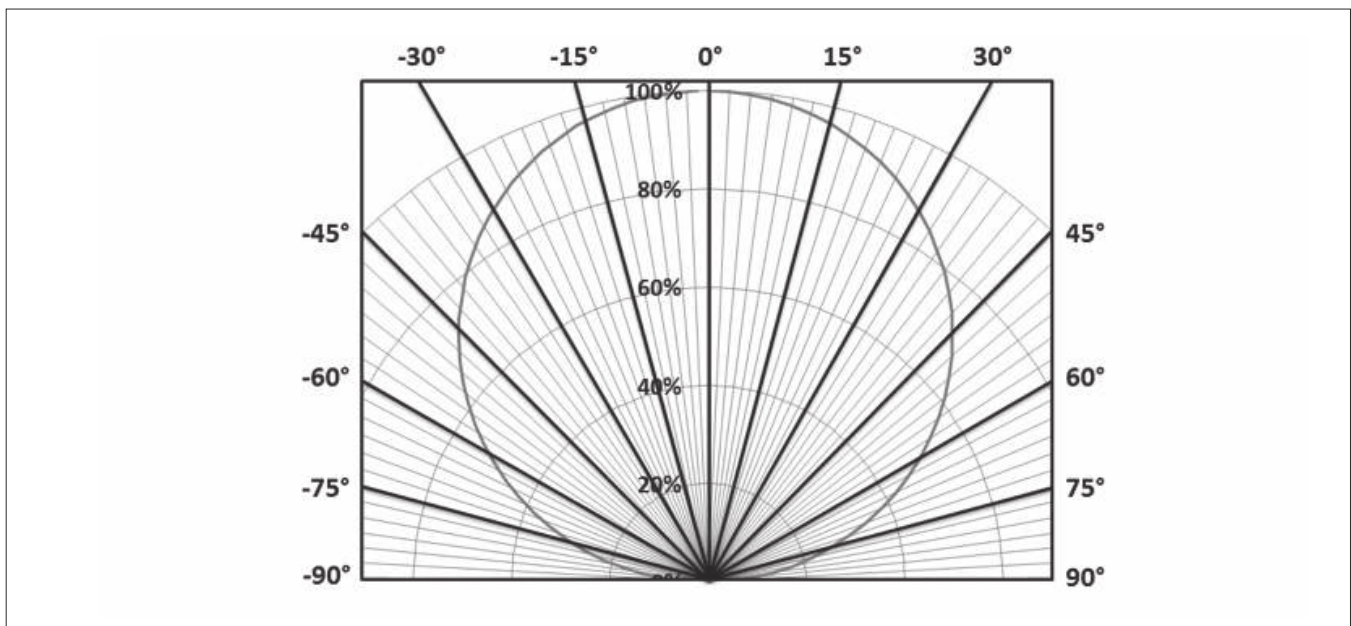

Typical Color Spectrum

Figure 19: Typical Color Spectrum

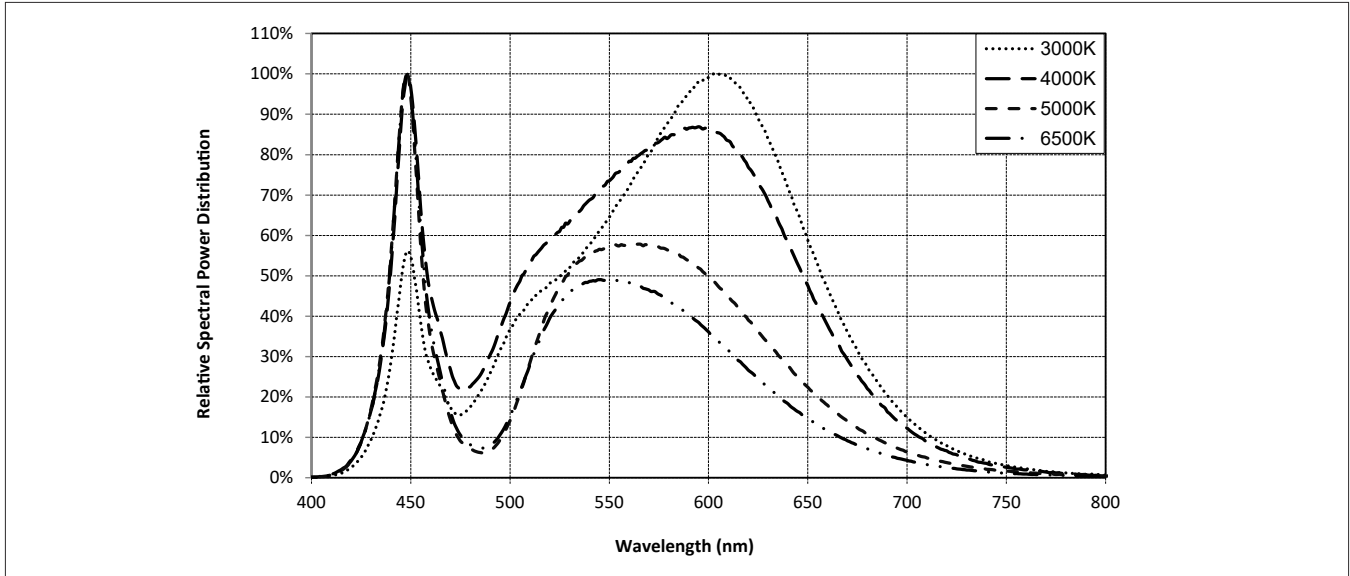

Notes for Figure 19:

1. Color spectra measured at nominal current for $T_j = T_c = 25^\circ\text{C}$.
2. Color spectra shown is 3000K and 80 CRI.
3. Color spectra shown is 4000K and 80 CRI.
4. Color spectra shown is 5000K and 70 CRI.
4. Color spectra shown is 6500K and 70 CRI.

Figure 20: Typical Color Spectrum for Vero SE 10 with Décor Series

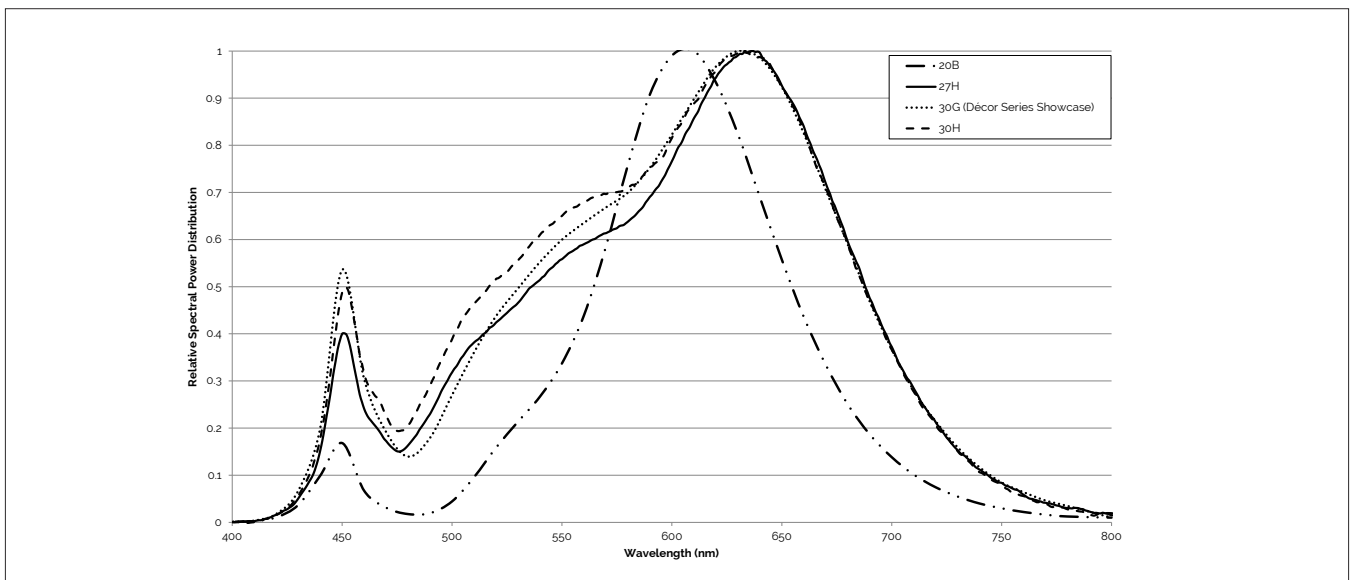

Note for Figure 20:

1. Color spectra measured at nominal current for $T_j = T_c = 25^\circ\text{C}$.

Mechanical Dimensions

Figure 21: Drawing for Vero SE 10 LED Array

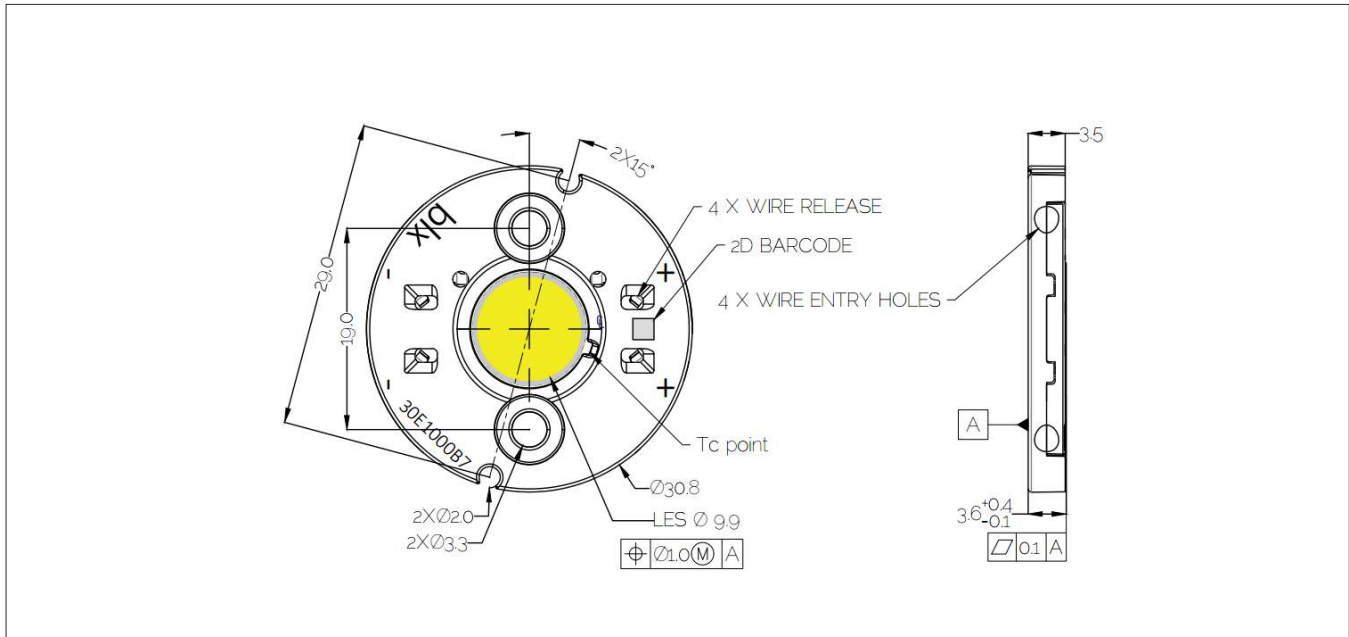

Notes for Figure 21:

1. Drawings are not to scale.
2. Dimensions are in mm.
3. Unless otherwise specified, tolerances are $\pm 0.10\text{mm}$.
4. Mounting holes (2X) are for M3 screws.
5. Bridgelux recommends two tapped holes for mounting screws with $19.0 \pm 0.10\text{mm}$ center-to-center spacing.
6. Screws with flat shoulders (pan, dome, button, round, truss, mushroom) provide optimal torque control. Do NOT use flat, countersink, or raised head screws.
7. The optical center of the LED Array is nominally defined by the mechanical center of the array to a tolerance of $\pm 0.2\text{mm}$.
8. Bridgelux maintains a flatness of 0.10mm across the mounting surface of the array.

Color Binning Information

Figure 22: Warm and Neutral White Test Bins in xy Color Space

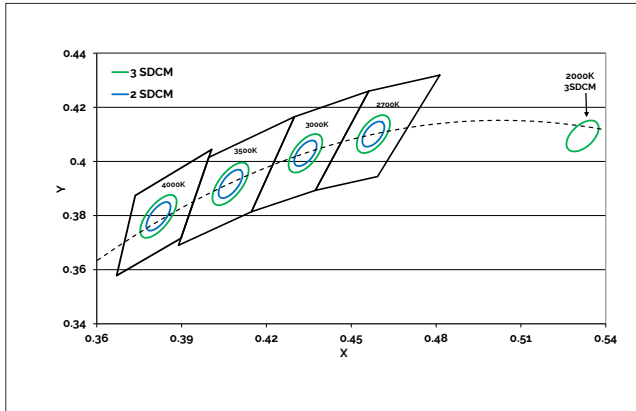

Note: Pulsed Test Conditions, $T_c = 25^\circ\text{C}$

Figure 23: Cool White Test Bins in xy Color Space

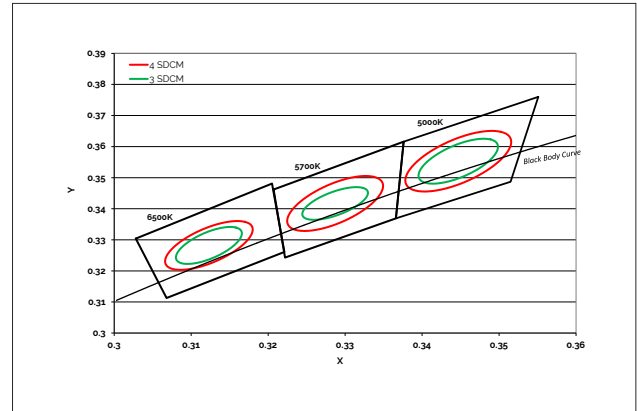

Note: Pulsed Test Conditions, $T_c = 25^\circ\text{C}$

Table 9: Warm and Neutral White xy Bin Coordinates and Associated Typical CCT

Bin Code ^a	2000K	2700K	3000K ^a	3500K ^a	4000K ^a
ANSI Bin (for reference only)	-	(2580K - 2870K)	(2870K - 3220K)	(3220K - 3710K)	(3710K - 4260K)
73 (3 SDCM)	-	(2651K - 2794K)	(2968K - 3136K)	(3369K - 3586K)	(3851K - 4130K)
72 (2 SDCM)	-	(2674K - 2769K)	(2995K - 3107K)	(3404K - 3548K)	(3895K - 4081K)
Center Point (x,y)	(0.5280, 0.4100)	(0.4578, 0.4101)	(0.4338, 0.403) (0.4465, 0.4024) ²	(0.4073, 0.3917)	(0.3818, 0.3797)

Notes for Table 9:

1. Color Binning information excludes Decor Series Class A products. Please contact your Bridgelux Sales Representative for more information.
2. Center Point for Decor Series Showcase.
3. Bridgelux maintains a tolerance of +/- 0.007 on x and y color coordinates in the CIE 1931 color Space.

Table 10: Cool White xy Bin Coordinates and Associated Typical CCT (product is hot targeted to $T_c = 85^\circ\text{C}$)

Bin Code	5000K	5700K	6500K
ANSI Bin (for reference only)	(4745K - 5311K)	(5312K - 6022K)	(6022K - 7042K)
74 (4 SDCM)	(4801K - 5282K)	(5395K - 5970K)	(6200K - 6910K)
73 (3 SDCM)	(4835K - 5215K)	(5460K - 5891K)	(6279K - 6811K)
Center Point (x,y)	(0.3447, 0.3553)	(0.3287, 0.3417)	(0.3123, 0.3282)

Note for Table 10:

1. Bridgelux maintains a tolerance of +/- 0.007 on x and y color coordinates in the CIE 1931 color Space.

Packaging and Labeling

Figure 24: Drawing for Vero SE 10 Packaging Tray

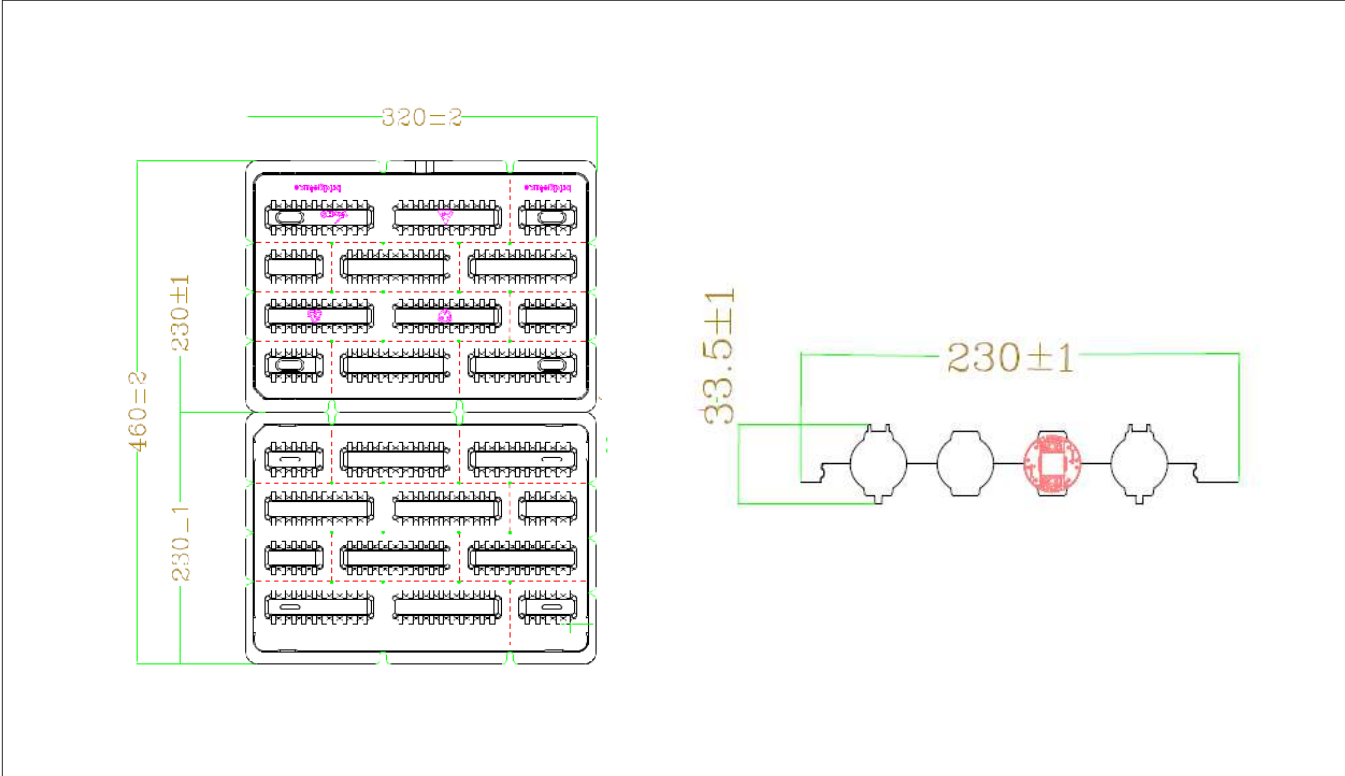

- Notes for Figure 24:
- 1. Dimensions are in millimeters.
 - 2. Drawings are not to scale.

Packaging and Labeling

Figure 25: Vero SE Series Packaging and Labeling

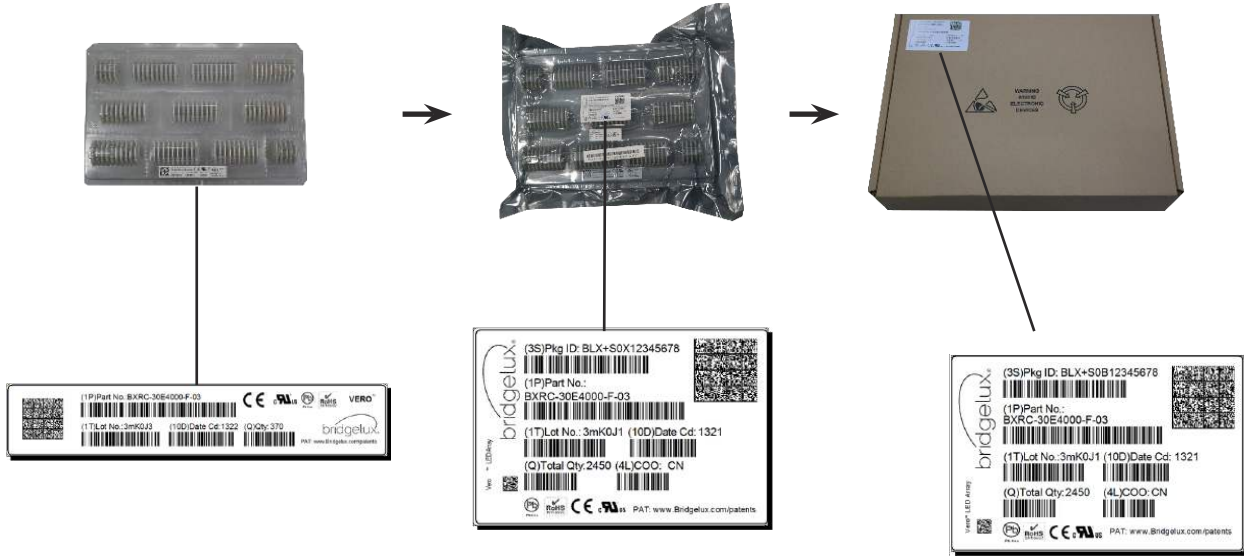

Notes for Figure 25:

1. Each tray holds 200 COBs.
2. Each tray is vacuum sealed in an anti-static bag and placed in its own box.
3. Each tray, bag and box is to be labeled as shown above.

Figure 26: Vero SE Product Labeling

Bridgelux COB arrays have laser markings on the back side of the substrate to help with product identification. In addition to the product identification markings, Bridgelux COB arrays also contain markings for internal Bridgelux manufacturing use only. The image below shows which markings are for customer use and which ones are for Bridgelux internal use only. The Bridgelux internal manufacturing markings are subject to change without notice, however these will not impact the form, function or performance of the COB array.



Customer Use- 2D Barcode
Scannable barcode provides product part number, V_r bin and other Bridgelux internal production information.

Customer Use- Product part number

30E1000C 72 2F

Customer Use- V_r Bin Code included to enable greater luminaire design flexibility. Refer to ANg2 for bin code definitions.

Design Resources

Application Notes

Bridgelux has developed a comprehensive set of application notes and design resources to assist customers in successfully designing with the Vero product family of LED array products. For all available application notes visit www.bridgelux.com.

Optical Source Models

Optical source models and ray set files are available for all Bridgelux products. For a list of available formats, visit www.bridgelux.com.

3D CAD Models

Three dimensional CAD models depicting the product outline of all Bridgelux Vero LED arrays are available in both IGS and STEP formats. Please contact your Bridgelux sales representative for assistance.

LM80

LM80 testing has been completed and the LM80 report is now available. Please contact your Bridgelux sales representative for LM-80 report.

Precautions

CAUTION: CHEMICAL EXPOSURE HAZARD

Exposure to some chemicals commonly used in luminaire manufacturing and assembly can cause damage to the LED array. Please consult Bridgelux Application Note AN121 for additional information.

CAUTION: RISK OF BURN

Do not touch the Vero LED array during operation. Allow the array to cool for a sufficient period of time before handling. The Vero LED array may reach elevated temperatures such that could burn skin when touched.

CAUTION

CONTACT WITH LIGHT EMITTING SURFACE (LES)

Avoid any contact with the LES. Do not touch the LES of the LED array or apply stress to the LES (yellow phosphor resin area). Contact may cause damage to the LED array.

Optics and reflectors must not be mounted in contact with the LES (yellow phosphor resin area). Optical devices may be mounted on the top surface of the plastic housing of the Vero LED array. Use the mechanical features of the LED array housing, edges and/or mounting holes to locate and secure optical devices as needed.

Disclaimers

MINOR PRODUCT CHANGE POLICY

The rigorous qualification testing on products offered by Bridgelux provides performance assurance. Slight cosmetic changes that do not affect form, fit, or function may occur as Bridgelux continues product optimization.

STANDARD TEST CONDITIONS

Unless otherwise stated, array testing is performed at the nominal drive current.

About Bridgelux: Bridging Light and Life™

At Bridgelux, we help companies, industries and people experience the power and possibility of light. Since 2002, we've designed LED solutions that are high performing, energy efficient, cost effective and easy to integrate. Our focus is on light's impact on human behavior, delivering products that create better environments, experiences and returns—both experiential and financial. And our patented technology drives new platforms for commercial and industrial luminaires.

For more information about the company, please visit
bridgelux.com
twitter.com/Bridgelux
facebook.com/Bridgelux
youtube.com/user/Bridgelux
linkedin.com/company/bridgelux-inc-_2
WeChat ID: BridgeluxInChina



46410 Fremont Boulevard
Fremont, CA 94538 U.S.A.
Tel (925) 583-8400
www.bridgelux.com

© 2021 Bridgelux, Inc. All rights reserved. Product specifications are subject to change without notice. Bridgelux, the Bridgelux stylized logo design, Vero, V Series, V Series HD and are registered trademarks, and Decor Series is a trademark of Bridgelux, Inc. All other trademarks are the property of their respective owners.

Bridgelux Vero SE 10 Array Series Product Data Sheet DS120 Rev. N (09/2021)