

# TMR4M02BG/3BG/4BG/5BG/8BG

## TMR Geartooth Sensor

### Description

The TMR4M02BG/3BG/4BG/5BG/8BG geartooth sensors are composed of a dual-channel push-pull Wheatstone full bridge including eight high-sensitivity tunneling magnetoresistance (TMR) sensing elements. The placement of TMR sensing elements is designed for specific gear pitches in different gear modules. The dual-channel Wheatstone full bridge outputs two orthogonal sine and cosine signals with the rotation of the gears. The period of this signal equals to the gear pitch to measure the rotation position and direction of the gear.

The TMR4M02BG/3BG/4BG/5BG/8BG series are available in the compact LGA6L(3 mm × 6 mm × 0.9 mm) packages, with different configurations of gear pitches in following gear modules:

- TMR4M02BG: module 0.2
- TMR4M03BG: module 0.3
- TMR4M04BG: module 0.4
- TMR4M05BG: module 0.5
- TMR4M08BG: module 0.8

### Features and benefits

- Tunneling magnetoresistance (TMR) technology
- Adapt to gears of different modules
- High saturation field
- DC (zero speed) operation
- Sine/cosine signal output with accurate phase difference
- Excellent thermal stability
- Excellent resistance to external magnetic field interference
- RoHS and REACH Compliant

### Applications

- Gear speed and direction measurement
- Linear and angular speed sensing
- Linear and angular displacement sensing

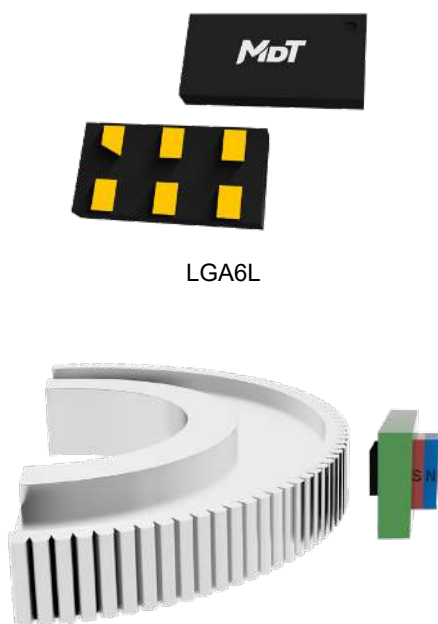

LGA6L

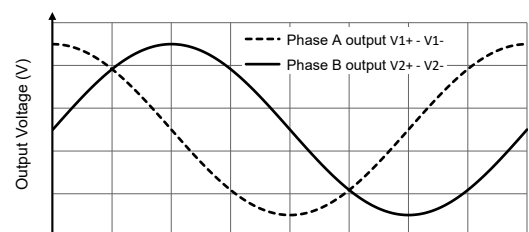

## Selection Guide

Part Number	Gear Module	Operating Ambient Temperature	Package	Packing Form
TMR4M02BG	0.2	-40 to 125°C	LGA6L	Tape & Reel
TMR4M03BG	0.3	-40 to 125°C	LGA6L	Tape & Reel
TMR4M04BG	0.4	-40 to 125°C	LGA6L	Tape & Reel
TMR4M05BG	0.5	-40 to 125°C	LGA6L	Tape & Reel
TMR4M08BG	0.8	-40 to 125°C	LGA6L	Tape & Reel

## Catalogue

1. Functional Block Diagram.....	03
2. Operating Principle .....	03
3. Pin Configuration .....	03
4. Absolute Maximum Ratings .....	04
5. Electrical Specifications.....	04
6. Dimensions.....	05

## 1. Functional Block Diagram

The TMR4M02BG/3BG/4BG/5BG/8BG geartooth sensors use dual Wheatstone bridges of high sensitivity TMR sensing elements to increase the sensors' output signal amplitude with enhanced temperature characteristic and anti-interference performance as shown in Figure 1.

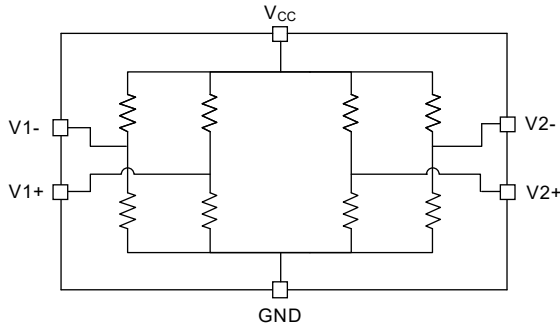

Figure 1. Block diagram

## 2. Operating Principle

The resistance value of the sensing elements changes with the target magnetic field, and the sensing direction is parallel to the chip surface as shown in Figure 2.

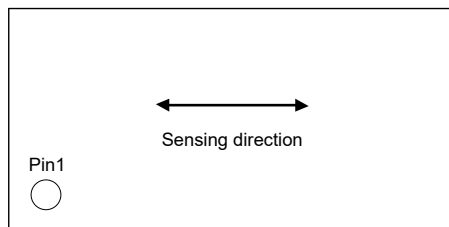

Figure 2. Sensing direction

The two bridges each output a sine wave signal with a phase difference of 90 degrees. The rotary position and direction of the gear can be calculated from the two output waveforms as shown in Figure 3.

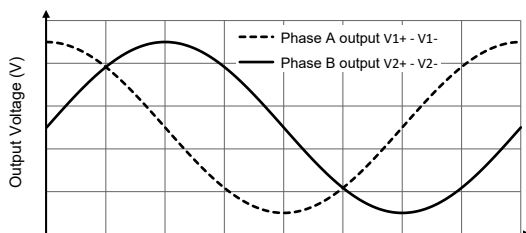

Figure 3. Gear tooth rotational displacement

## 3. Pin Configuration

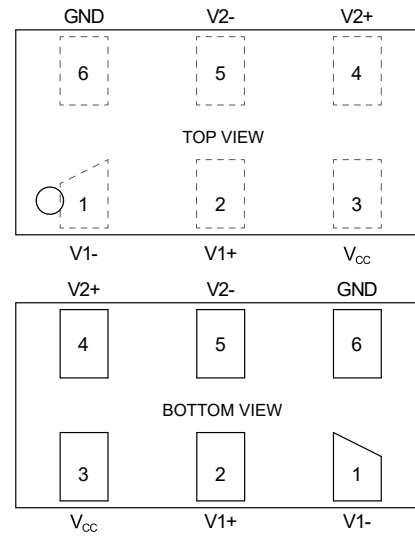

Figure 4. Pin configuration (LGA6L)

Number	Name	Function
1	V1-	Phase A negative output
2	V1+	Phase A positive output
3	V <sub>CC</sub>	Power supply
4	V2+	Phase B positive output
5	V2-	Phase B negative output
6	GND	Ground

## 4. Absolute Maximum Ratings

Parameters	Symbol	Min.	Max.	Unit
Supply voltage	$V_{CC}$	-7	7	V
Magnetic flux density	$B$	-	1500	Gs <sup>1)</sup>
ESD performance (HBM)	$V_{ESD}$	-	4000	V
Operating ambient temperature	$T_A$	-40	125	°C
Storage ambient temperature	$T_{STG}$	-50	150	°C

## 5. Electrical Specifications

$V_{CC} = 5\text{ V}$ ,  $T_A = 25\text{ °C}$ , a  $0.1\text{ }\mu\text{F}$  capacitor is connected between  $V_{CC}$  and GND

Parameter	Symbol	Condition	Min.	Typ.	Max.	Unit
Supply voltage	$V_{CC}$	operating	-	3	7	V
Bridge resistance	$R_B$	-	-	2 <sup>2)</sup>	-	k $\Omega$
Resistance temperature coefficient	$TCR_B$	$B = 0\text{ Gs}$	-	-0.10	-	%/°C
Offset	$V_{OFFSET}$	-	-20	-	20	mV/V

Notes:

- 1) 1 Oe (Oersted) = 1 Gauss in air = 0.1 millitesla = 79.8 A/m.
- 2) Bridge resistance (resistance between  $V_{CC}$  and GND at zero field) can be custom designed. Please contact MultiDimension Technology for details.

## 6. Dimensions

### LGA6L Package

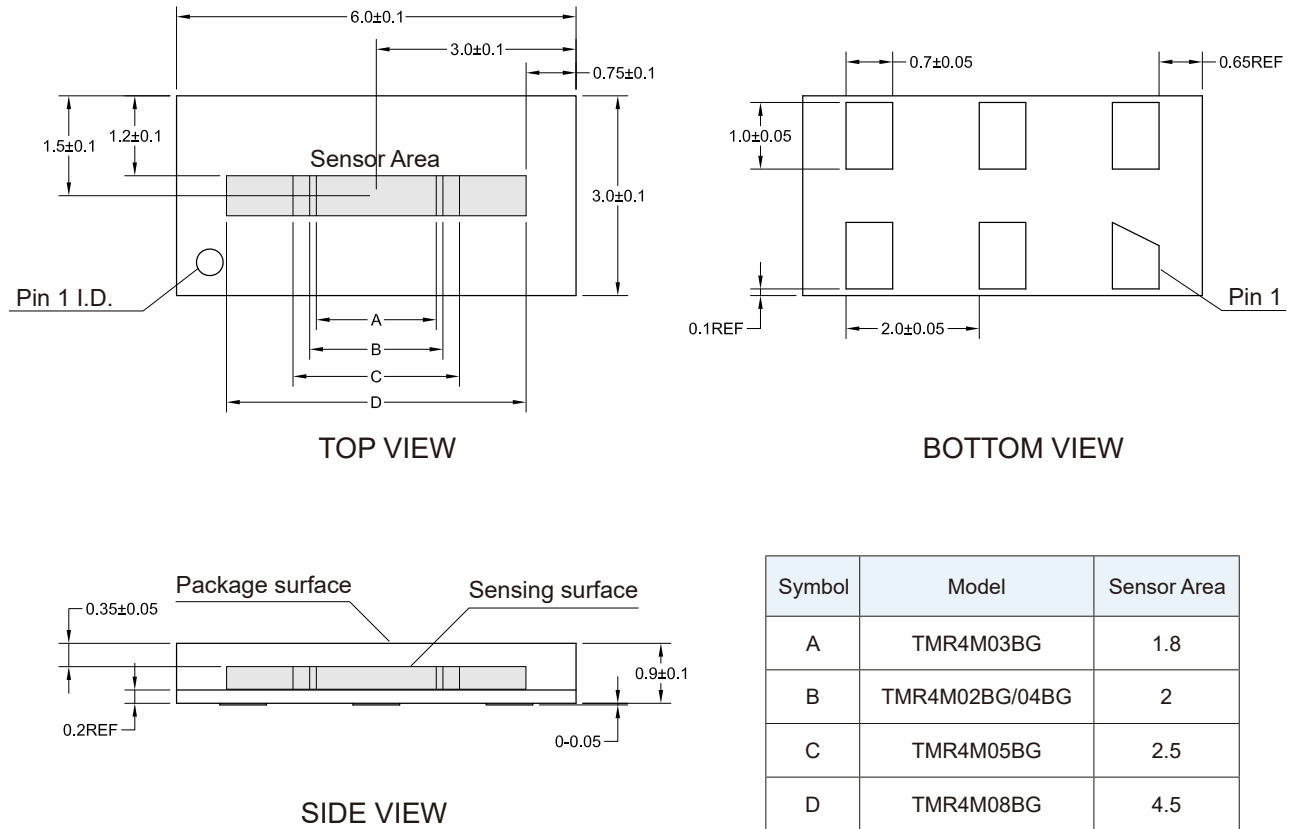

Figure 5. Package outline of LGA6L (unit: mm)

## Copyright © 2022 by MultiDimension Technology Co., Ltd.

Information furnished herein by MultiDimension Technology Co., Ltd. (hereinafter MDT) is believed to be accurate and reliable. However, MDT disclaims any and all warranties and liabilities of any kind, with respect to any examples, hints or any performance or use of technical data as described herein and/or any information regarding the application of the product, including without limitation warranties of non-infringement of intellectual property rights of any third party. This document neither conveys nor implies any license under patent or other industrial or intellectual property rights. Customer or any third-party must further determine the suitability of the MDT products for its applications to avoid the applications default of customer or third-party. MDT accept no liability in this respect.

MDT does not assume any liabilities of any indirect, incidental, punitive, special or consequential damages (including without limitation of lost profits, lost savings, business interruption, costs related to the removal or replacement of any products or rework charges) whether or not such damages are based on tort (including negligence), warranty, breach of contract or any other legal theory. Notwithstanding any damages that customer might incur for any reason whatsoever, MDT's aggregate and cumulative liability towards customer for the products described herein shall be limited in accordance with the terms and conditions of commercial sale of MDT.

Absolute maximum ratings are the extreme limits the device will withstand without damage to the MDT product. However, the electrical and mechanical characteristics are not guaranteed as the maximum limits (above recommended operating conditions) are approached. MDT disclaims any and all warranties and liabilities of the MDT product will operate at absolute maximum ratings.

Specifications may change without notice.

Please download latest document from our official website [www.dowaytech.com/en](http://www.dowaytech.com/en).

## Recycling

The product(s) in this document need to be handed over to a qualified solid waste management services company for recycling in accordance with relevant regulations on waste classification after the end of the product(s) life.



No.2 Guangdong Road, Zhangjiagang Free Trade Zone, Jiangsu, China

Web: [www.dowaytech.com/en](http://www.dowaytech.com/en) E-mail: [info@dowaytech.com](mailto:info@dowaytech.com)

