



Single Port RJ45 PoE+ Connector

AR11-4522I



- 100/1000 Base T Gigabit for PoE+ Application
- Compliant with IEEE 802.3 at standard
- RJ45 Jack cavity conforms to FCC rules and regulations Part 68, SUB Part F
- Industrial Operating Temp: -40°C +85°C

Electrical Specifications @ 25°C

OCL(μH Min) @100KHz, 0.1V	Turns Ratio ±3%		Return Loss (dB Min)			Cross Talk (dB Min)		
	TX	RX	1-30MHz	30-60MHz	60-100MHz	0.5-10MHz	10-30MHz	30-50MHz
With 20mA DC Bias 350	1:1	1:1	-18	-15	-12	-50	-40	-35

Electrical Specifications @ 25°C

Insertion Loss (dB Max)	Common Mode Rejection (dB Min)	Balance DC Line Current @57VDC		DCR Max	Hi-Pot Test
		720mA Max	1.2A Max		
@1-100MHz -1.0	@1-100MHz -30	Continuous	200 Milisec.	1.2Ω	1500Vrms

All specifications subject to change without notice.

MECHANICAL

Dimensions: (mm)

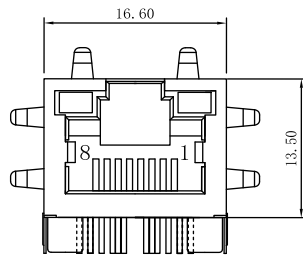

Front View

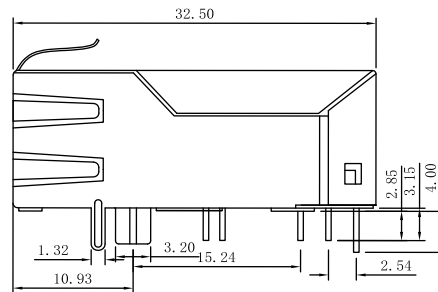

Side View

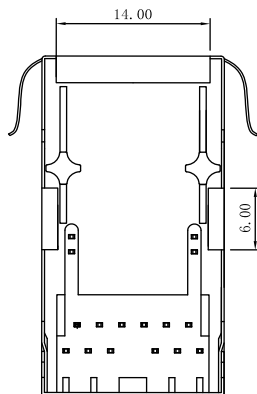

Bottom View

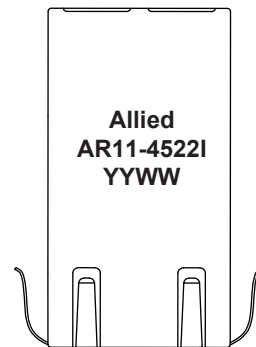

Top View



SCHEMATIC

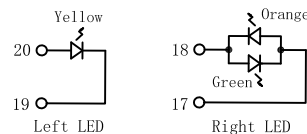
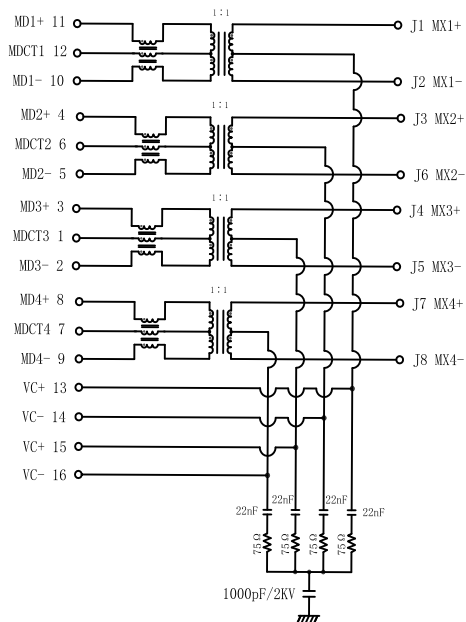

Emitting Color	λ p(nm)	VF@IF=20mA	IR @VR=5V
Green	565	1.8~2.6V	10 μ A max
Yellow	585	1.8~2.6V	10 μ A max
Orange	610	1.8~2.6V	10 μ A max

PCB LAYOUT

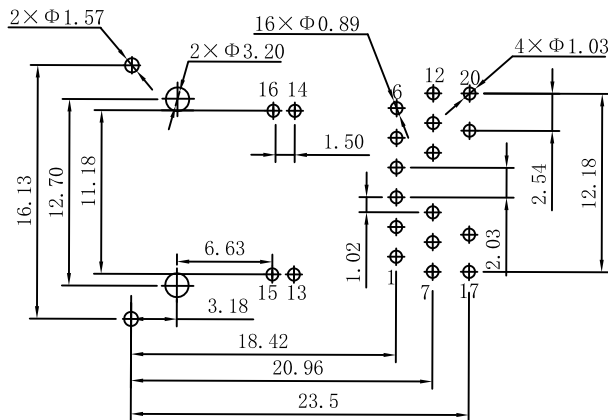

NOTES

- | | |
|---------------------|--|
| 1. Shield- | Copper alloy Brass H65Y Thickness=0.2mm |
| 2. Housing- | Thermoplastic PBT+30%G.F UL94V-0 |
| 3. Contact- | Phosphor Bronze C5210R-EH Thickness=0.35mm |
| 4. Contact Plating- | Gold 6 micro-inches min. In contact area |
| 5. Pins- | Brass C2680R-H Thickness=0.35mm |