



16-Channel, Constant-Current LED Driver with Switching Delay

Check for Samples: [TLC59284](#)

FEATURES

- 16-Channel, Constant-Current Sink Output with On and Off Control
- Constant-Current Sink Capability:
 - 35 mA ($V_{CC} \leq 3.6$ V)
 - 45 mA ($V_{CC} > 3.6$ V)
- LED Power-Supply Voltage: Up to 10 V
- V_{CC} : 3 V to 5.5 V
- Constant-Current Accuracy:
 - Channel-to-Channel: $\pm 1.4\%$ (typ), $\pm 3\%$ (max)
 - Device-to-Device: $\pm 2\%$ (typ), $\pm 4\%$ (max)
- CMOS Logic Level I/O
- Data Transfer Rate: 35 MHz
- BLANK Pulse Width: 50 ns
- Switching Delay for Noise Reduction
- Operating Temperature: -40°C to $+85^{\circ}\text{C}$

APPLICATIONS

- Video Displays
- Message Boards

DESCRIPTION

The TLC59284 is a 16-channel, constant-current sink light-emitting diode (LED) driver. Each channel can be individually controlled with a simple serial communications protocol that is compatible with 3.3-V or 5-V CMOS logic levels, depending on the operating VCC. When the serial data buffer is loaded, a LAT rising edge transfers the data to the OUT n outputs. The BLANK pin can be used to turn off all OUT n outputs during power-on and output data latching to prevent unwanted image displays during these times. The constant-current value of all 16 channels is set by a single external resistor.

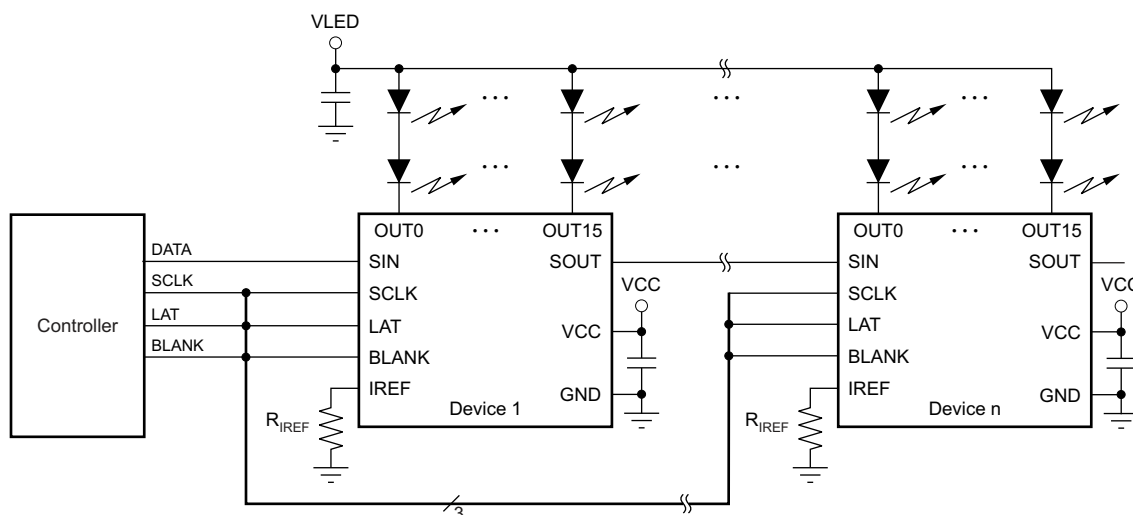

Typical Application Circuit (Multiple Daisy-Chainned TLC59284s)



Please be aware that an important notice concerning availability, standard warranty, and use in critical applications of Texas Instruments semiconductor products and disclaimers thereto appears at the end of this data sheet.

All trademarks are the property of their respective owners.



This integrated circuit can be damaged by ESD. Texas Instruments recommends that all integrated circuits be handled with appropriate precautions. Failure to observe proper handling and installation procedures can cause damage.

ESD damage can range from subtle performance degradation to complete device failure. Precision integrated circuits may be more susceptible to damage because very small parametric changes could cause the device not to meet its published specifications.

PACKAGE AND ORDERING INFORMATION⁽¹⁾

PRODUCT	PACKAGE-LEAD	ORDERING NUMBER	TRANSPORT MEDIA, QUANTITY
TLC59284	SSOP-24, QSOP-24	TLC59284DBQR	Tape and Reel, 2500
		TLC59284DBQ	Tube, 50

- (1) For the most current package and ordering information, see the Package Option Addendum at the end of this document, or visit the device product folder at www.ti.com.

ABSOLUTE MAXIMUM RATINGS⁽¹⁾⁽²⁾

Over operating free-air temperature range, unless otherwise noted.

		VALUE		UNIT
		MIN	MAX	
Supply voltage	V_{CC}	-0.3	+6	V
Input voltage range, V_{IN}	SIN, SCLK, LAT, BLANK, IREF	-0.3	$V_{CC} + 0.3$	V
Output voltage range, V_{OUT}	Output range, SOUT	-0.3	$V_{CC} + 0.3$	V
	Output range, OUT0 to OUT15	-0.3	+11	V
Current, I_{OUT}	Output (dc), OUT0 to OUT15		+50	mA
Temperature	Operating junction, $T_{J(MAX)}$		+150	°C
	Storage range, T_{stg}	-55	+150	°C
Electrostatic discharge (ESD) ratings	Human body model (HBM)		4000	V
	Charged device model (CDM)		2000	V

- (1) Stresses above these ratings may cause permanent damage. Exposure to absolute maximum conditions for extended periods may degrade device reliability. These are stress ratings only, and functional operation of the device at these or any other conditions beyond those specified is not supported.
- (2) All voltage values are with respect to network ground terminal.

THERMAL INFORMATION

THERMAL METRIC ⁽¹⁾		TLC59284	UNITS
		DBQ	
		24 PINS	
θ_{JA}	Junction-to-ambient thermal resistance	91.5	°C/W
θ_{JCTop}	Junction-to-case (top) thermal resistance	55.2	
θ_{JB}	Junction-to-board thermal resistance	44.9	
Ψ_{JT}	Junction-to-top characterization parameter	16.8	
Ψ_{JB}	Junction-to-board characterization parameter	44.5	
θ_{JCbott}	Junction-to-case (bottom) thermal resistance	N/A	

- (1) For more information about traditional and new thermal metrics, see the *IC Package Thermal Metrics* application report, [SPRA953](http://www.ti.com/lit/zip/Spra953).

RECOMMENDED OPERATING CONDITIONS

 At $T_A = -40^\circ\text{C}$ to $+85^\circ\text{C}$, unless otherwise noted.

PARAMETER			TEST CONDITIONS	TLC59284		UNIT
				MIN	MAX	
DC CHARACTERISTICS ($V_{CC} = 3\text{ V to }5.5\text{ V}$)						
V_{CC}	Supply voltage			3	5.5	V
V_O	Voltage applied to output		OUT0 to OUT15		10	V
V_{IH}	Input voltage	High	SIN, SCLK, LAT, BLANK	$0.7 \times V_{CC}$	V_{CC}	V
V_{IL}		Low	SIN, SCLK, LAT, BLANK	GND	$0.3 \times V_{CC}$	V
I_{OH}	Output current	High	SOUT		-2	mA
I_{OL}		Low	SOUT		2	mA
I_{OLC}	Constant output sink current		OUT0 to OUT15, $3\text{ V} \leq V_{CC} \leq 3.6\text{ V}$	2	35	mA
			OUT0 to OUT15, $3.6\text{ V} < V_{CC} \leq 5.5\text{ V}$	2	45	mA
T_A	Temperature range	Operating free-air		-40	+85	$^\circ\text{C}$
T_J		Operating junction		-40	+125	$^\circ\text{C}$
AC CHARACTERISTICS ($V_{CC} = 3\text{ V to }5.5\text{ V}$)						
f_{CLK} (SCLK)	Data shift clock frequency		SCLK		35	MHz
t_{WH0}	Pulse duration		SCLK	10		ns
t_{WL0}			SCLK	10		ns
t_{WH1}			LAT	20		ns
t_{WH2}			BLANK	100		ns
t_{WL2}			BLANK	50		ns
t_{SU0}	Setup time	SIN \uparrow – SCLK \uparrow		4		ns
t_{SU1}		LAT \downarrow – SCLK \uparrow		10		ns
t_{H0}	Hold time	SIN \uparrow – SCLK \uparrow		4		ns
t_{H1}		LAT \downarrow – SCLK \uparrow		10		ns

ELECTRICAL CHARACTERISTICS

All minimum and maximum specifications are at $T_A = -40^\circ\text{C}$ to $+85^\circ\text{C}$ and $V_{CC} = 3\text{ V}$ to 5.5 V , unless otherwise noted. Typical specifications are at $T_A = +25^\circ\text{C}$ and $V_{CC} = 3.3\text{ V}$.

PARAMETER			TEST CONDITIONS	TLC59284			UNIT	
				MIN	TYP	MAX		
V_{OH}	Output voltage	High	$I_{OH} = -2\text{ mA}$ at SOUT	$V_{CC} - 0.4$		V_{CC}	V	
V_{OL}		Low	$I_{OL} = 2\text{ mA}$ at SOUT			0.4	V	
V_{IREF}	Reference voltage output		$R_{IREF} = 1.5\text{ k}\Omega$, $T_A = +25^\circ\text{C}$		1.208		V	
I_{IN}	Input current		$V_{IN} = V_{CC}$ or GND at SIN and SCLK	-1		1	μA	
I_{CC0}	Supply current (V_{CC})		SIN, SCLK, LAT = GND, BLANK = $V_{OUTn} = V_{CC}$, $R_{IREF} = \text{open}$		1	2	mA	
I_{CC1}			SIN, SCLK, LAT = GND, BLANK = $V_{OUTn} = V_{CC}$, $R_{IREF} = 3\text{ k}\Omega$ ($I_{OUT} = 17.6\text{ mA}$ target)		3	4	mA	
I_{CC2}			All $OUTn = \text{ON}$, SIN, SCLK, LAT, BLANK = GND, $V_{OUTn} = 0.8\text{ V}$, $R_{IREF} = 3\text{ k}\Omega$		7	9	mA	
I_{CC3}			All $OUTn = \text{ON}$, SIN, SCLK, LAT, BLANK = GND, $V_{OUTn} = 0.8\text{ V}$, $R_{IREF} = 1.5\text{ k}\Omega$ ($I_{OUT} = 35.3\text{ mA}$ target)		8	11	mA	
I_{OLC}	Constant output current		All $OUTn = \text{ON}$, $V_{OUTn} = V_{OUTfix} = 0.8\text{ V}$, $R_{IREF} = 1.5\text{ k}\Omega$, $T_A = +25^\circ\text{C}$ (see Figure 8)	32.9	35.3	37.7	mA	
I_{OLKG0}	Output leakage current		All $OUTn = \text{OFF}$, $V_{OUTn} = V_{OUTfix} = 10\text{ V}$, BLANK = V_{CC} , $R_{IREF} = 1.5\text{ k}\Omega$ (see Figure 8)			0.1	μA	
				$T_J = +25^\circ\text{C}$			0.2	μA
				$T_J = +85^\circ\text{C}$			0.07	0.5
ΔI_{OLC0}	Constant-current error	Channel-to-channel ⁽¹⁾	All $OUTn = \text{ON}$, $V_{OUTn} = V_{OUTfix} = 0.8\text{ V}$, $R_{IREF} = 1.5\text{ k}\Omega$, $T_A = +25^\circ\text{C}$ (see Figure 8)		± 1.4	± 3	%	
		Device-to-device ⁽²⁾	All $OUTn = \text{ON}$, $V_{OUTn} = V_{OUTfix} = 0.8\text{ V}$, $R_{IREF} = 1.5\text{ k}\Omega$, $T_A = +25^\circ\text{C}$ (see Figure 8)		± 2	± 4	%	
ΔI_{OLC2}	Line regulation ⁽³⁾		All $OUTn = \text{ON}$, $V_{OUTn} = V_{OUTfix} = 0.8\text{ V}$, $R_{IREF} = 1.5\text{ k}\Omega$, $V_{CC} = 3\text{ V}$ to 5.5 V		± 0.05	± 1	%/V	
ΔI_{OLC3}	Load regulation ⁽⁴⁾		All $OUTn = \text{ON}$, $V_{OUTn} = 0.8\text{ V}$ to 3 V , $V_{OUTfix} = 0.8\text{ V}$, $R_{IREF} = 1.5\text{ k}\Omega$		± 0.5	± 1	%/V	
R_{PUP}	Resistor	Pull-up	BLANK	250	500	750	k Ω	
R_{PDWN}		Pull-down	LAT	250	500	750	k Ω	

(1) The deviation of each output from the average of OUT0 to OUT15 constant-current. Deviation is calculated by the formula:

$$\Delta (\%) = \left[\frac{I_{OUTn}}{\frac{(I_{OUT0} + I_{OUT1} + \dots + I_{OUT14} + I_{OUT15})}{16}} - 1 \right] \times 100$$

(2) The deviation of the OUT0 to OUT15 constant-current average from the ideal constant-current value. Deviation is calculated by the following formula:

$$\Delta (\%) = \left[\frac{\frac{(I_{OUT0} + I_{OUT1} + \dots + I_{OUT14} + I_{OUT15})}{16} - (\text{Ideal Output Current})}{\text{Ideal Output Current}} \right] \times 100$$

Ideal current is calculated by the formula:

$$I_{OUT(\text{IDEAL})} = 43.8 \times \left[\frac{1.208\text{ V}}{R_{IREF}} \right]$$

(3) Line regulation is calculated by this equation:

$$\Delta (\%/V) = \left[\frac{(I_{OUTn} \text{ at } V_{CC} = 5.5\text{ V}) - (I_{OUTn} \text{ at } V_{CC} = 3\text{ V})}{(I_{OUTn} \text{ at } V_{CC} = 3\text{ V})} \right] \times \frac{100}{5.5\text{ V} - 3\text{ V}}$$

(4) Load regulation is calculated by the equation:

$$\Delta (\%/V) = \left[\frac{(I_{OUTn} \text{ at } V_{OUTn} = 3\text{ V}) - (I_{OUTn} \text{ at } V_{OUTn} = 1\text{ V})}{(I_{OUTn} \text{ at } V_{OUTn} = 1\text{ V})} \right] \times \frac{100}{3\text{ V} - 1\text{ V}}$$

SWITCHING CHARACTERISTICS

All minimum and maximum specifications are at $T_A = -40^{\circ}\text{C}$ to $+85^{\circ}\text{C}$, $V_{CC} = 3\text{ V}$ to 5.5 V , $C_L = 15\text{ pF}$, $R_L = 110\ \Omega$, $R_{IREF} = 1.5\text{ k}\Omega$, and $V_{LED} = 5.0\text{ V}$, unless otherwise noted. Typical values are at $T_A = +25^{\circ}\text{C}$ and $V_{CC} = 3.3\text{ V}$.

PARAMETER		TEST CONDITIONS	TLC59284			UNIT
			MIN	TYP	MAX	
t_{R0}	Rise time	SOUT (see Figure 7)		3	10	ns
t_{R1}		OUT n (see Figure 6)		44		ns
t_{F0}	Fall time	SOUT (see Figure 7)		3	10	ns
t_{F1}		OUT n (see Figure 6)		44		ns
t_{D0}	Propagation delay time	SCLK \uparrow to SOUT $\uparrow\downarrow$		11	20	ns
t_{D1}		LAT \uparrow or BLANK $\uparrow\downarrow$ to OUT0 on or off, $T_A = +25^{\circ}\text{C}$		60	100	ns
t_{D2}		Grouped OUT n on or off to next group on or off, $T_A = +25^{\circ}\text{C}$		2		ns
t_{ON_ERR}	Output on-time error ⁽¹⁾	Output on or off latch data = all '1', 50-ns BLANK GND level pulse, $V_{CC} = 3.3\text{ V}$, $T_A = +25^{\circ}\text{C}$		-45	45	ns

- (1) Output on-time error (t_{ON_ERR}) is calculated by the formula: t_{ON_ERR} (ns) = t_{OUT_ON} – BLANK low-level one-shot pulse width (t_{WL2}). t_{OUT_ON} indicates the actual on-time of the constant-current output.

PIN CONFIGURATIONS

**DBQ PACKAGE
SSOP-24 AND QSOP-24
(TOP VIEW)**

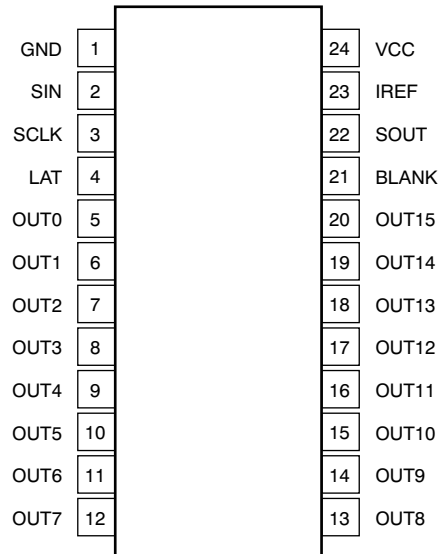

PIN DESCRIPTIONS

PIN		I/O	DESCRIPTION
NAME	NUMBER		
BLANK	21	I	All outputs empty (blank); Schmitt buffer input. When BLANK is high, all constant-current outputs (OUT0 to OUT15) are forced off. When BLANK is low, all constant-current outputs are controlled by the data in the output on or off data latch. This pin is internally pulled up to V_{CC} with a 500-k Ω (typ) resistor.
GND	1	—	Power ground
IREF	23	I/O	Constant-current value setting, the OUT0 to OUT15 sink constant-current outputs are set to the desired values by connecting an external resistor between IREF and GND.
LAT	4	I	Level-triggered latch; Schmitt buffer input. The data in the 16-bit shift register continue to transfer to the output on or off data latch while LAT is high. Therefore, if the data in the 16-bit shift register are changed when LAT is high, the data in the data latch are also changed. The data in the data latch are held when LAT is low. This pin is internally pulled down to GND with a 500-k Ω (typ) resistor.
OUT0	5	O	Constant-current output. Each output can be tied together with others to increase the constant-current. Different voltages can be applied to each output.
OUT1	6	O	Constant-current output
OUT2	7	O	Constant-current output
OUT3	8	O	Constant-current output
OUT4	9	O	Constant-current output
OUT5	10	O	Constant-current output
OUT6	11	O	Constant-current output
OUT7	12	O	Constant-current output
OUT8	13	O	Constant-current output
OUT9	14	O	Constant-current output
OUT10	15	O	Constant-current output
OUT11	16	O	Constant-current output
OUT12	17	O	Constant-current output
OUT13	18	O	Constant-current output
OUT14	19	O	Constant-current output
OUT15	20	O	Constant-current output
SCLK	3	I	Serial data shift clock; Schmitt buffer input. All data in the 16-bit shift register are shifted toward the MSB by a 1-bit SCLK synchronization.
SIN	2	I	Serial data input for driver on or off control; Schmitt buffer input. When SIN is high, the LSB is set to '1' for only one SCLK input rising edge. If two SCLK rising edges are input while SIN is high, then the 16-bit shift register LSB and LSB+1 are set to '1'. When SIN is low, the LSB is set to '0' at the SCLK input rising edge.
SOUT	22	O	Serial data output. This output is connected to the 16-bit shift register MSB. SOUT data changes at the SCLK rising edge.
VCC	24	—	Power-supply voltage

FUNCTIONAL BLOCK DIAGRAM

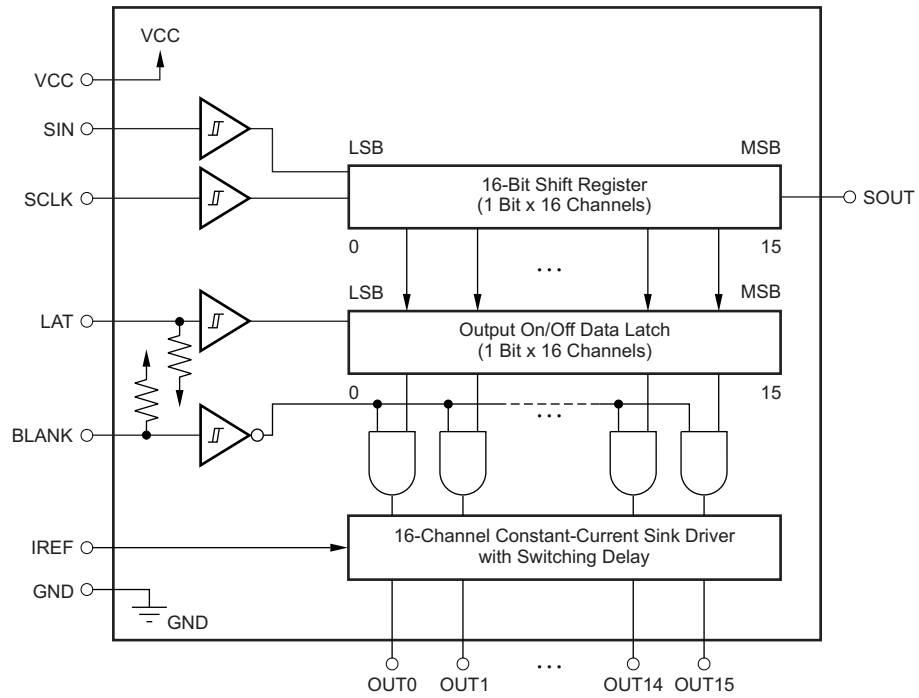

PARAMETER MEASUREMENT INFORMATION

PIN-EQUIVALENT INPUT AND OUTPUT SCHEMATIC DIAGRAMS

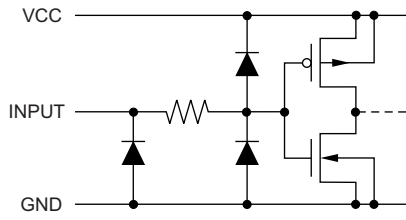

Figure 1. SIN and SCLK

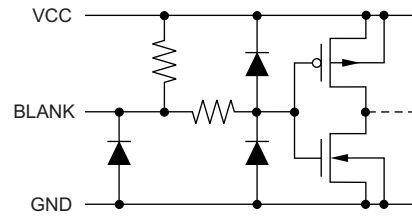

Figure 3. BLANK

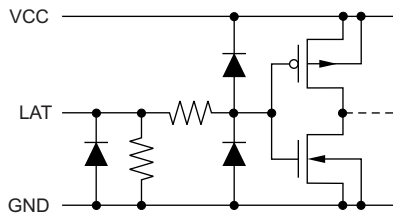

Figure 2. LAT

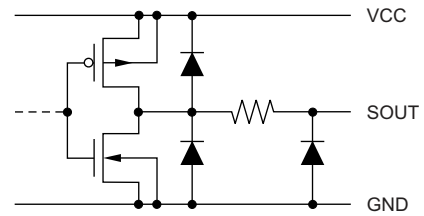
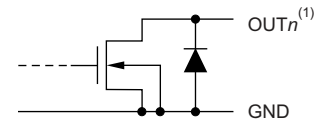

Figure 4. SOUT



(1) n = 0 to 15.

Figure 5. OUT0 Through OUT15

TEST CIRCUITS

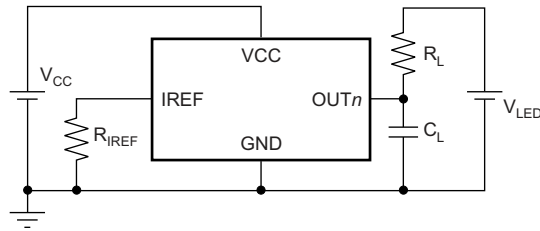

Figure 6. OUT_n Rise and Fall Time Test Circuit

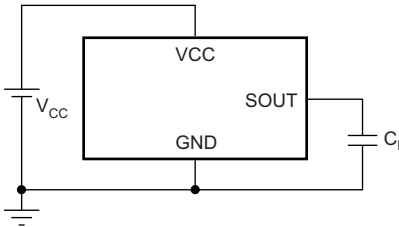

Figure 7. SOUT Rise and Fall Time Test Circuit

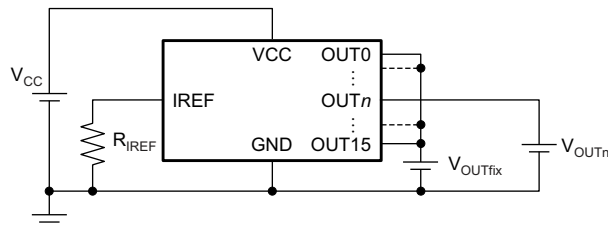
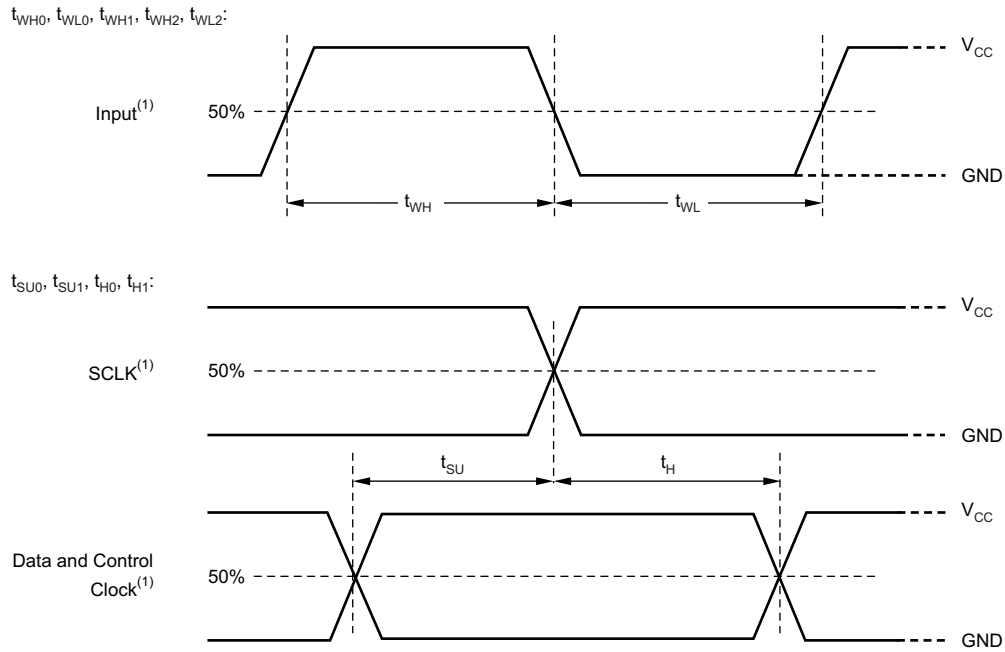

Figure 8. OUT_n Constant-Current Test Circuit

TIMING DIAGRAMS



(1) Input pulse rise and fall time is 1 ns to 3 ns.

Figure 9. Input Timing Diagram

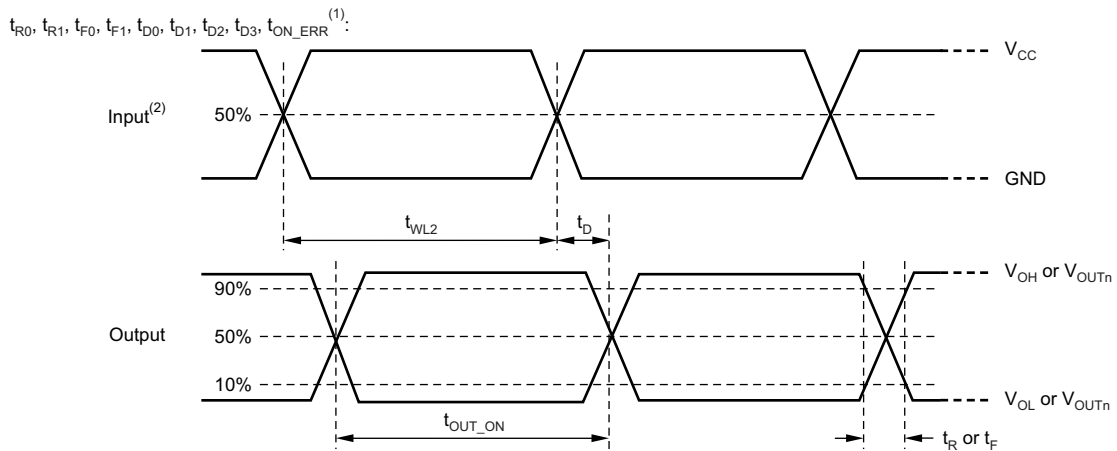

(1) t_{ON_ERR} is calculated by $t_{OUT_ON} - t_{WL2}$.

(2) Input pulse rise and fall time is 1 ns to 3 ns.

Figure 10. Output Timing Diagram

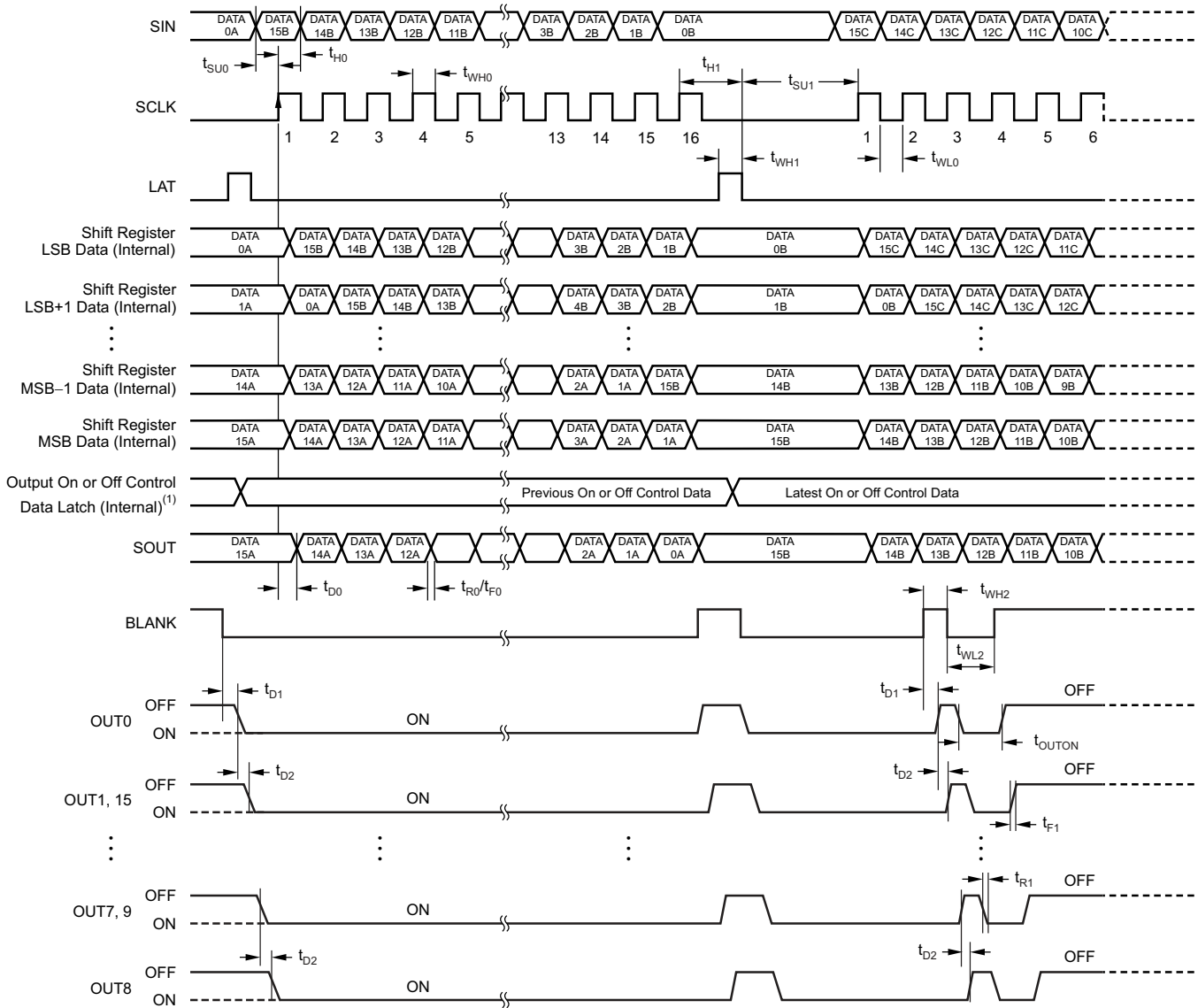

(1) Output on or off data = FFFFh.

(2) $t_{ON_ERR} = t_{OUTON} - t_{WL2}$.

Figure 11. Data Write and Output On or Off Timing Diagram

TYPICAL CHARACTERISTICS

At $T_A = +25^\circ\text{C}$ and $V_{CC} = 3.3\text{ V}$, unless otherwise noted.

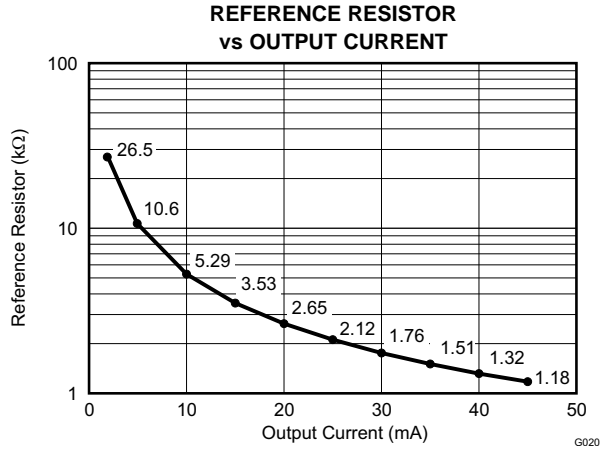

Figure 12.

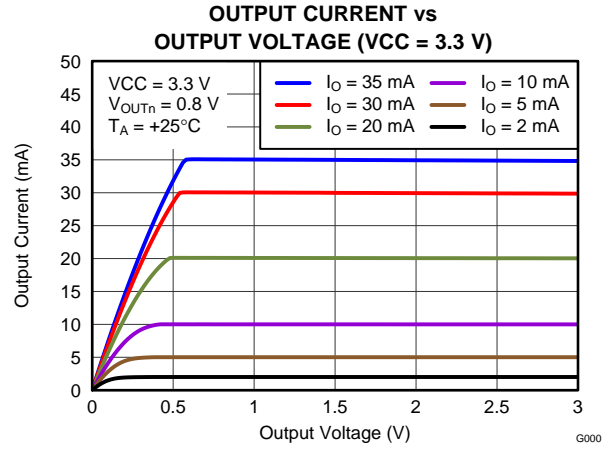

Figure 13.

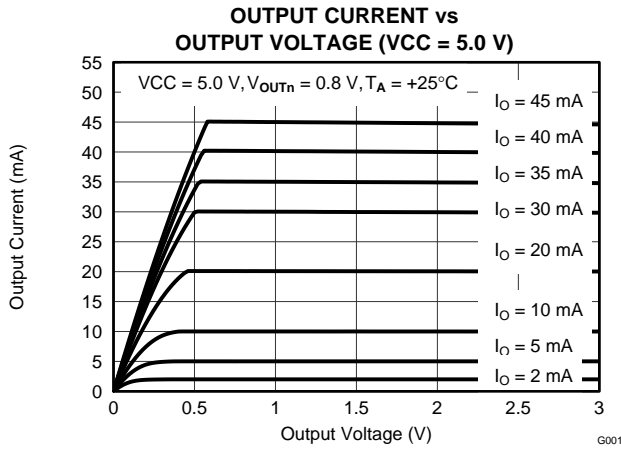

Figure 14.

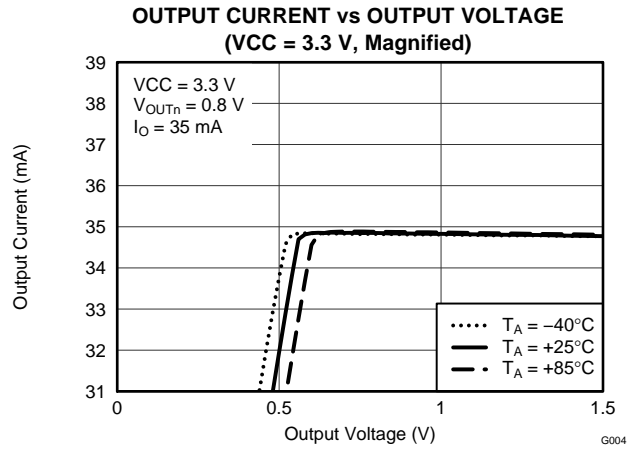

Figure 15.

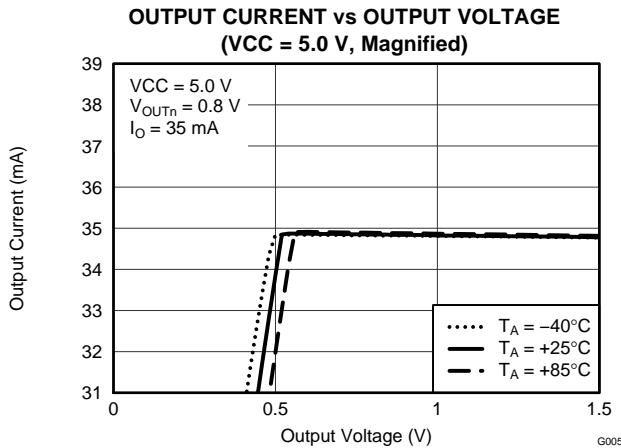

Figure 16.

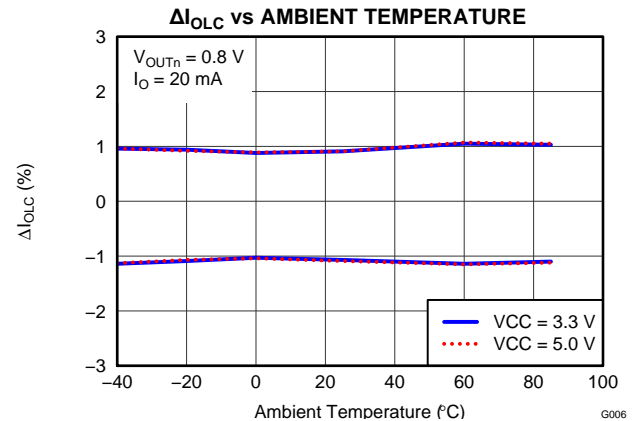

Figure 17.

TYPICAL CHARACTERISTICS (continued)

At $T_A = +25^\circ\text{C}$ and $V_{CC} = 3.3\text{ V}$, unless otherwise noted.

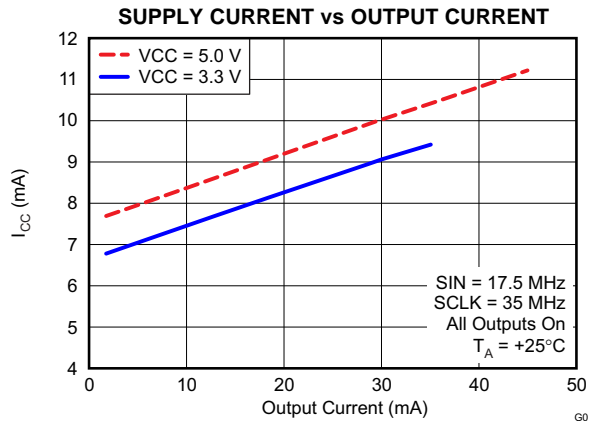

Figure 18.

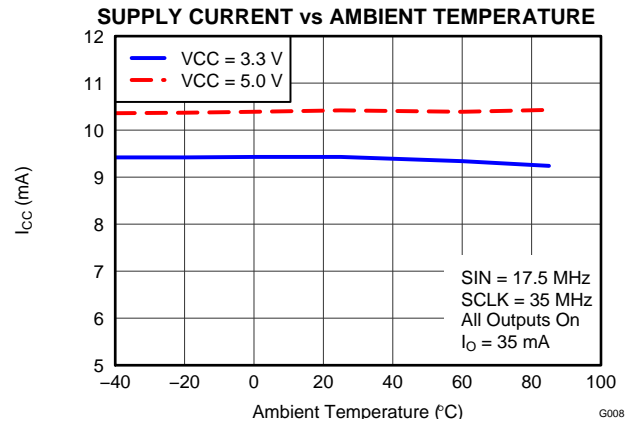

Figure 19.

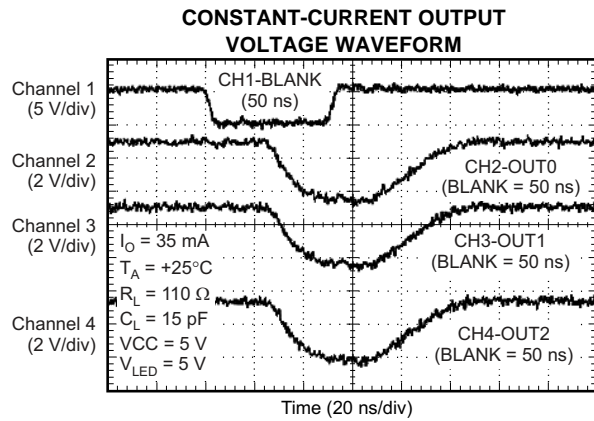

Figure 20.

DETAILED DESCRIPTION

CONSTANT SINK CURRENT VALUE SETTING

The constant-current values are determined by an external resistor (R_{IREF}) placed between IREF and GND. The resistor (R_{IREF}) value is calculated by [Equation 1](#).

$$R_{IREF} \text{ (k}\Omega\text{)} = \frac{V_{IREF} \text{ (V)}}{I_{OLC} \text{ (mA)}} \times 43.8$$

Where:

$$V_{IREF} = \text{the internal reference voltage on the IREF pin (typically 1.208 V)} \quad (1)$$

I_{OLC} must be set in the range of 2 mA to 35 mA when V_{CC} is less than 3.6 V. Also, when V_{CC} is equal to 3.6 V or greater, I_{OLC} must be set in the range of 2 mA to 45 mA. The constant sink current characteristic for the external resistor value is illustrated in [Figure 12](#). [Table 1](#) describes the constant-current output versus external resistor value.

Table 1. Constant-Current Output versus External Resistor Value

I_{OLC} (mA)	R_{IREF} (k Ω , Typical)
45 ($V_{CC} > 3.6$ V only)	1.18
40 ($V_{CC} > 3.6$ V only)	1.32
35	1.51
30	1.76
25	2.12
20	2.65
15	3.53
10	5.29
5	10.6
2	26.5

CONSTANT-CURRENT DRIVER ON OR OFF CONTROL

When BLANK is low, the corresponding output is turned on if the data in the on or off control data latch are '1' and remains off if the data are '0'. When BLANK is high, all outputs are forced off. This control is shown in [Table 2](#).

Table 2. Output On or Off Control Data Truth Table

OUTPUT ON OR OFF DATA	CONSTANT-CURRENT OUTPUT STATUS
0	Off
1	On

When the device is initially powered on, the data in the 16-bit shift register and output on or off data latch are not set to default values. Therefore, the output on or off data must be written to the data latch before turning the constant-current output on. **BLANK should be high when powered on because the constant-current may be turned on as a result of random data in the output on or off data latch.**

REGISTER CONFIGURATION

The TLC59284 has a 16-bit shift register and an output on or off data latch. Both the shift register and data latch are 16 bits long and are used to turn the constant-current outputs on and off. Figure 21 shows the shift register and data latch configuration. The data at the SIN pin are shifted into the 16-bit shift register LSB at the rising edge of the SCLK pin; SOUT data change at the SCLK rising edge.

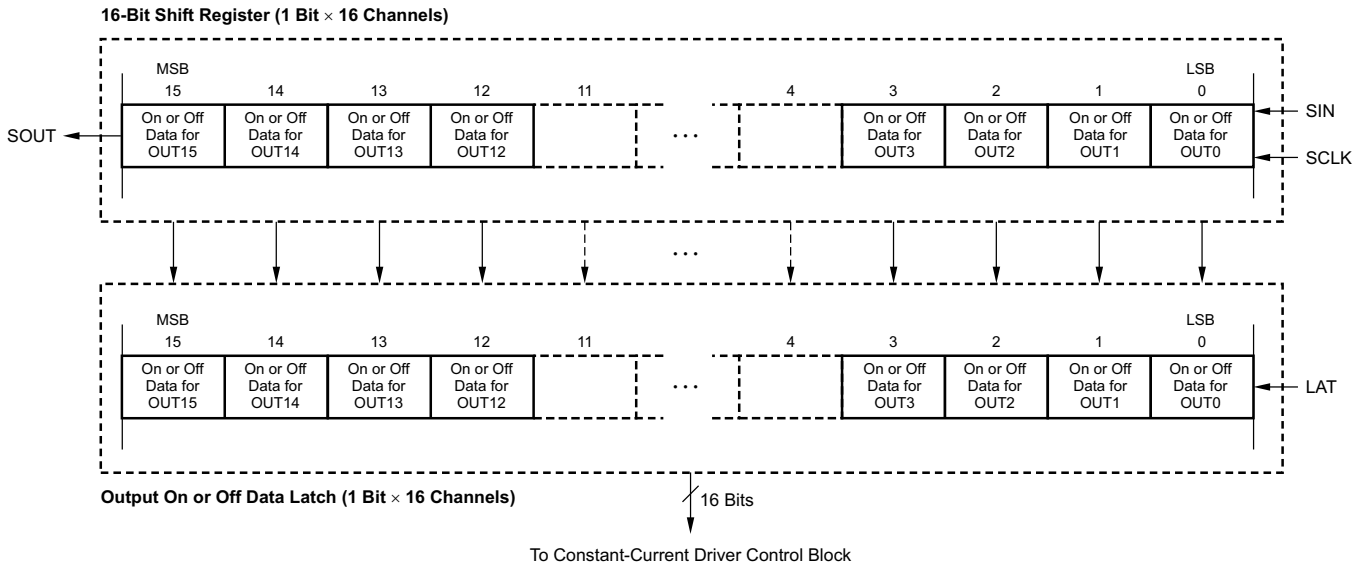

Figure 21. 16-Bit Shift Register and Output On or Off Data Latch Configuration

The output on or off data in the 16-bit shift register continue to transfer to the output on or off data latch while LAT is high. Therefore, if the data in the 16-bit shift register are changed when LAT is high, the data in the data latch are also changed. The data in the data latch are held when LAT is low. When the device initially powers on, the data in the output on or off shift register and latch are not set to default values; on or off control data must be written to the on or off control data latch before turning the constant-current output on. All constant-current outputs are forced off when BLANK is high. The OUT_n on or off outputs are controlled by the data in the output on or off data latch. The writing data truth table and timing diagram are shown in Table 3 and Figure 22, respectively.

Table 3. Truth Table in Operation

SCLK	LAT	BLANK	SIN	OUT0...OUT7...OUT15	SOUT
↑	High	Low	D _n	D _n ...D _{n-7} ...D _{n-15}	D _{n-15}
↑	Low	Low	D _{n+1}	No change	D _{n-14}
↑	High	Low	D _{n+2}	D _{n+2} ...D _{n-5} ...D _{n-13}	D _{n-13}
↓	—	Low	D _{n+3}	D _{n+2} ...D _{n-5} ...D _{n-13}	D _{n-13}
↓	—	High	D _{n+3}	Off	D _{n-13}

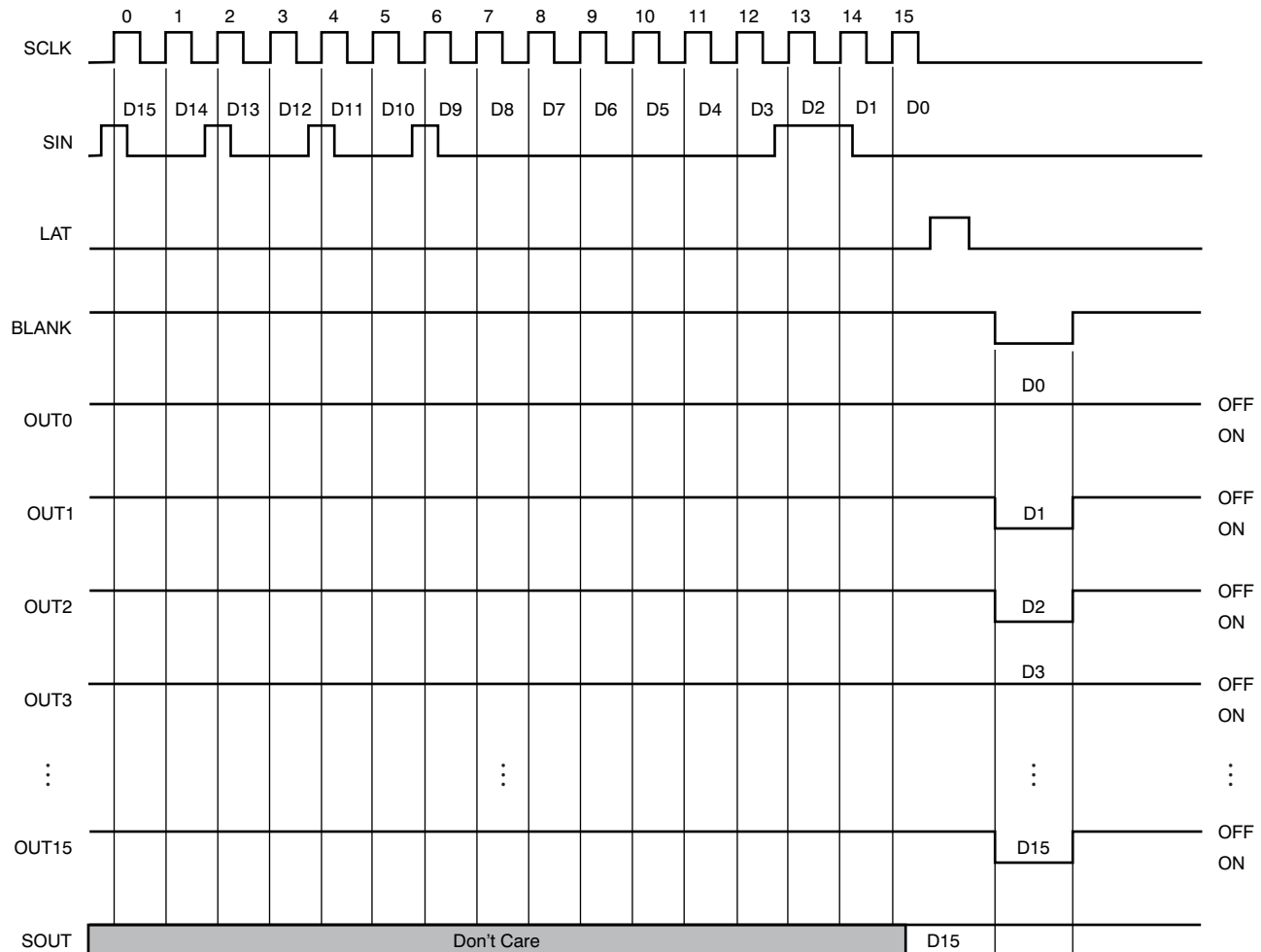

Figure 22. Operation Timing Diagram

NOISE REDUCTION

Large surge currents may flow through the device and board if all 16 outputs turn on or off simultaneously. These large current surges can induce detrimental noise and electromagnetic interference (EMI) into other circuits. The TLC59284 independently turns on or off the outputs for each group with a 1-ns (typ) delay time; see [Figure 11](#). The 16 outputs are grouped into nine groups of either one or two outputs: group 1 (OUT0), group 2 (OUT1 and OUT15), group 3 (OUT2 and OUT14), group 4 (OUT3 and OUT13), group 5 (OUT4 and OUT12), group 6 (OUT5 and OUT11), group 7 (OUT6 and OUT10), group 8 (OUT7 and OUT9), and group 9 (OUT9). Both turn-on and turn-off times are delayed when BLANK transitions from low to high or high to low. Also when output-on and -off data are changed at the LAT rising edge while BLANK is low, both turn-on and turn-off times are delayed. However, the state of each output is controlled by the data in the output on or off data latch and the BLANK level.

REVISION HISTORY

NOTE: Page numbers for previous revisions may differ from page numbers in the current version.

Changes from Original (October 2012) to Revision A	Page
• Changed HBM ESD rating maximum specification in Absolute Maximum Ratings table	2
• Changed I_{CC2} maximum specification in Electrical Characteristics table	4

PACKAGING INFORMATION

Orderable Device	Status (1)	Package Type	Package Drawing	Pins	Package Qty	Eco Plan (2)	Lead finish/ Ball material (6)	MSL Peak Temp (3)	Op Temp (°C)	Device Marking (4/5)	Samples
TLC59284DBQ	ACTIVE	SSOP	DBQ	24	50	RoHS & Green	NIPDAU	Level-2-260C-1 YEAR	-40 to 85	TLC59284	Samples
TLC59284DBQR	ACTIVE	SSOP	DBQ	24	2500	RoHS & Green	NIPDAU	Level-2-260C-1 YEAR	-40 to 85	TLC59284	Samples

(1) The marketing status values are defined as follows:

ACTIVE: Product device recommended for new designs.

LIFEBUY: TI has announced that the device will be discontinued, and a lifetime-buy period is in effect.

NRND: Not recommended for new designs. Device is in production to support existing customers, but TI does not recommend using this part in a new design.

PREVIEW: Device has been announced but is not in production. Samples may or may not be available.

OBSELETE: TI has discontinued the production of the device.

(2) **RoHS:** TI defines "RoHS" to mean semiconductor products that are compliant with the current EU RoHS requirements for all 10 RoHS substances, including the requirement that RoHS substance do not exceed 0.1% by weight in homogeneous materials. Where designed to be soldered at high temperatures, "RoHS" products are suitable for use in specified lead-free processes. TI may reference these types of products as "Pb-Free".

RoHS Exempt: TI defines "RoHS Exempt" to mean products that contain lead but are compliant with EU RoHS pursuant to a specific EU RoHS exemption.

Green: TI defines "Green" to mean the content of Chlorine (Cl) and Bromine (Br) based flame retardants meet JS709B low halogen requirements of <=1000ppm threshold. Antimony trioxide based flame retardants must also meet the <=1000ppm threshold requirement.

(3) MSL, Peak Temp. - The Moisture Sensitivity Level rating according to the JEDEC industry standard classifications, and peak solder temperature.

(4) There may be additional marking, which relates to the logo, the lot trace code information, or the environmental category on the device.

(5) Multiple Device Markings will be inside parentheses. Only one Device Marking contained in parentheses and separated by a "~" will appear on a device. If a line is indented then it is a continuation of the previous line and the two combined represent the entire Device Marking for that device.

(6) Lead finish/Ball material - Orderable Devices may have multiple material finish options. Finish options are separated by a vertical ruled line. Lead finish/Ball material values may wrap to two lines if the finish value exceeds the maximum column width.

Important Information and Disclaimer:The information provided on this page represents TI's knowledge and belief as of the date that it is provided. TI bases its knowledge and belief on information provided by third parties, and makes no representation or warranty as to the accuracy of such information. Efforts are underway to better integrate information from third parties. TI has taken and continues to take reasonable steps to provide representative and accurate information but may not have conducted destructive testing or chemical analysis on incoming materials and chemicals. TI and TI suppliers consider certain information to be proprietary, and thus CAS numbers and other limited information may not be available for release.

In no event shall TI's liability arising out of such information exceed the total purchase price of the TI part(s) at issue in this document sold by TI to Customer on an annual basis.

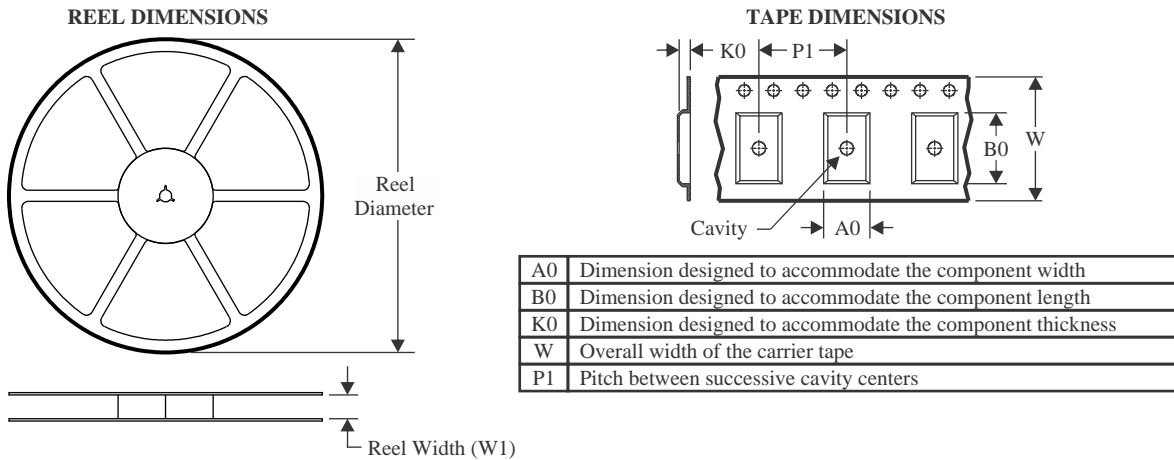
TAPE AND REEL INFORMATION

QUADRANT ASSIGNMENTS FOR PIN 1 ORIENTATION IN TAPE



*All dimensions are nominal

Device	Package Type	Package Drawing	Pins	SPQ	Reel Diameter (mm)	Reel Width W1 (mm)	A0 (mm)	B0 (mm)	K0 (mm)	P1 (mm)	W (mm)	Pin1 Quadrant
TLC59284DBQR	SSOP	DBQ	24	2500	330.0	16.4	6.5	9.0	2.1	8.0	16.0	Q1

TAPE AND REEL BOX DIMENSIONS

*All dimensions are nominal

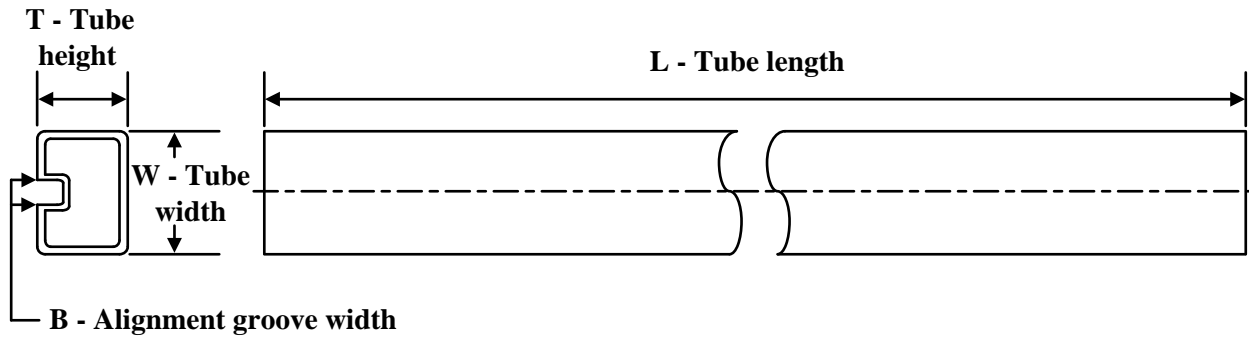
Device	Package Type	Package Drawing	Pins	SPQ	Length (mm)	Width (mm)	Height (mm)
TLC59284DBQR	SSOP	DBQ	24	2500	356.0	356.0	35.0

TUBE

*All dimensions are nominal

Device	Package Name	Package Type	Pins	SPQ	L (mm)	W (mm)	T (μm)	B (mm)
TLC59284DBQ	DBQ	SSOP	24	50	506.6	8	3940	4.32

IMPORTANT NOTICE AND DISCLAIMER

TI PROVIDES TECHNICAL AND RELIABILITY DATA (INCLUDING DATA SHEETS), DESIGN RESOURCES (INCLUDING REFERENCE DESIGNS), APPLICATION OR OTHER DESIGN ADVICE, WEB TOOLS, SAFETY INFORMATION, AND OTHER RESOURCES "AS IS" AND WITH ALL FAULTS, AND DISCLAIMS ALL WARRANTIES, EXPRESS AND IMPLIED, INCLUDING WITHOUT LIMITATION ANY IMPLIED WARRANTIES OF MERCHANTABILITY, FITNESS FOR A PARTICULAR PURPOSE OR NON-INFRINGEMENT OF THIRD PARTY INTELLECTUAL PROPERTY RIGHTS.

These resources are intended for skilled developers designing with TI products. You are solely responsible for (1) selecting the appropriate TI products for your application, (2) designing, validating and testing your application, and (3) ensuring your application meets applicable standards, and any other safety, security, regulatory or other requirements.

These resources are subject to change without notice. TI grants you permission to use these resources only for development of an application that uses the TI products described in the resource. Other reproduction and display of these resources is prohibited. No license is granted to any other TI intellectual property right or to any third party intellectual property right. TI disclaims responsibility for, and you will fully indemnify TI and its representatives against, any claims, damages, costs, losses, and liabilities arising out of your use of these resources.

TI's products are provided subject to [TI's Terms of Sale](#) or other applicable terms available either on ti.com or provided in conjunction with such TI products. TI's provision of these resources does not expand or otherwise alter TI's applicable warranties or warranty disclaimers for TI products.

TI objects to and rejects any additional or different terms you may have proposed.

Mailing Address: Texas Instruments, Post Office Box 655303, Dallas, Texas 75265
Copyright © 2022, Texas Instruments Incorporated