

S21MA7-P08MFD0-527S
medi_snap, type_s2

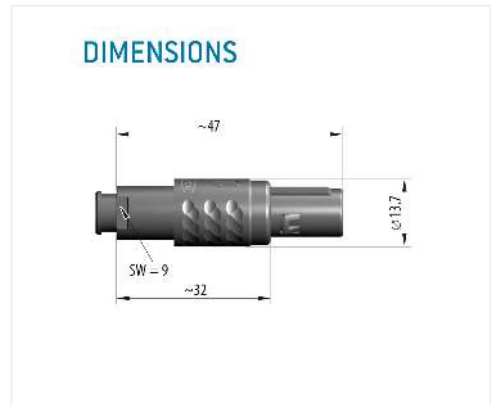

General information

Part number	S21MA7-P08MFD0-527S
Termination	solder
Size	1
Locking principle	push
Coding	a_key_medi
Cable Diameter	cable_medi_52
Cable outlet	bend_relief

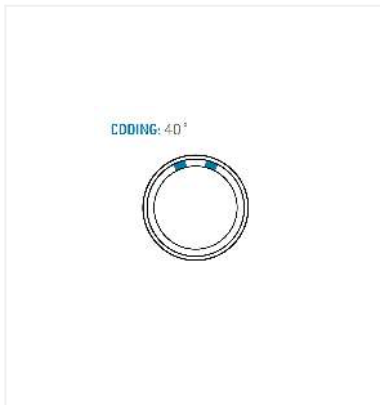

Contact insert description

Number of contacts	8
Contact type	pins
Contact diameter	07mm
Insulator material	peek
Wire cross section	26_awg
Termination	solder
Termination diameter	065mm

reverse_gender_on_request

Technical information

Max. creepage and air clearance distance	06_mm	
Nominal current single contact	06_a	iec_60512_5_2
Nominal current insert	3,9 A	vde_0298_4
Test voltage	16_kv_dc	sae_13441

safety_text

Mechanical and environmental data

Degree of protection*	ip50
Operating temperature	50_120_c
Mating cycles	2000

mated_unmated

Insulator materials MEDI-SNAP®

psu_peek

Material and surface treatments

Housing	psu_gray
Color option	gray
Contact	cu_alloy_gold

safety_text_2
ul_text
illustrative_text