

## LOS-RS

~9.6° spot beam optimized for Osram Oslon Square EC. 14.3 mm high assembly.

### SPECIFICATION:

Dimensions	Ø 21.6 mm
Height	14.3 mm
Fastening	glue, pin
ROHS compliant	yes ⓘ

### MATERIALS:

Component	Type	Material	Colour	Finish
LXP2-RS	Single lens	PMMA	clear	
LEILA-HLD-OSL	Holder	PC	white	



### ORDERING INFORMATION:

Component	Type	Qty in box	MOQ	MPQ	Box weight (kg)
CP12412_LOS-RS	Single lens	1680	336	112	9.1
» Box size: 480 x 280 x 300 mm					

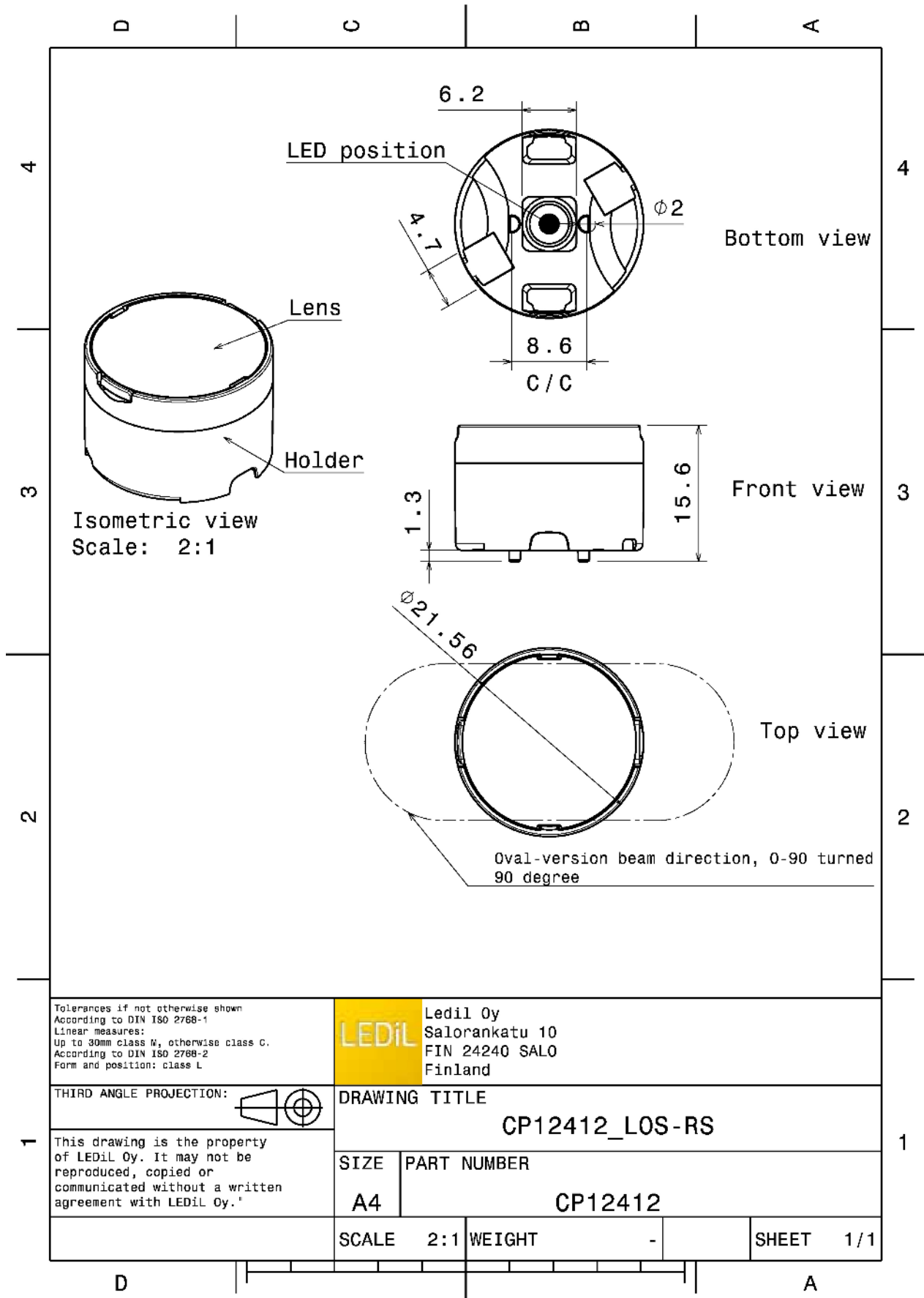

Tolerances if not otherwise shown  
According to DIN ISO 2768-1  
Linear measures:  
Up to 30mm class M, otherwise class C.  
According to DIN ISO 2768-2  
Form and position: class L



Ledil Oy  
Salorankatu 10  
FIN 24240 SALO  
Finland

THIRD ANGLE PROJECTION:

DRAWING TITLE

CP12412\_LOS-RS

This drawing is the property of LEDiL Oy. It may not be reproduced, copied or communicated without a written agreement with LEDiL Oy.

SIZE

PART NUMBER

A4

CP12412

SCALE

2:1

WEIGHT



-

SHEET

1/1

See also our general installation guide: [www.ledil.com/installation\\_guide](http://www.ledil.com/installation_guide)

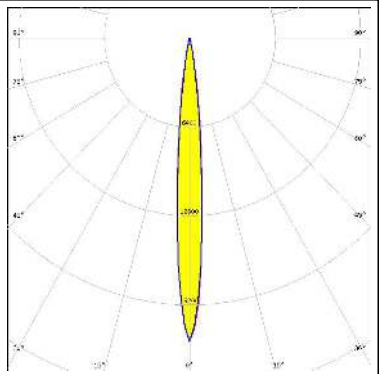
### OPTICAL RESULTS (MEASURED):

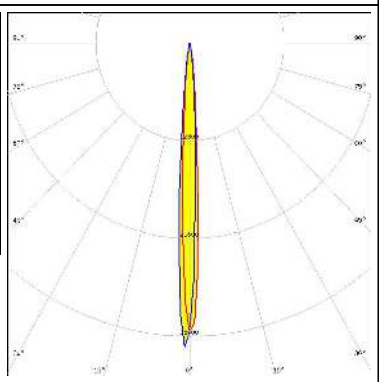
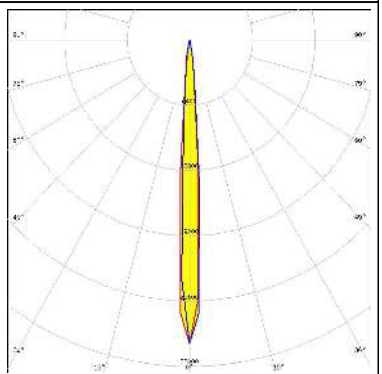
<p><b>OSRAM</b> Opto Semiconductors</p> <p>LED OSLON Square EC</p> <p>FWHM / FWTM 10.0° / 20.0°</p> <p>Efficiency 94 %</p> <p>Peak intensity 20.9 cd/lm</p> <p>LEDs/each optic 1</p> <p>Light colour White</p> <p>Required components:</p>		
<p><b>OSRAM</b> Opto Semiconductors</p> <p>LED OSLON SSL 150</p> <p>FWHM / FWTM 6.0° / 15.0°</p> <p>Efficiency 93 %</p> <p>Peak intensity 40 cd/lm</p> <p>LEDs/each optic 1</p> <p>Light colour White</p> <p>Required components:</p>		
<p><b>OSRAM</b> Opto Semiconductors</p> <p>LED OSLON SSL 80</p> <p>FWHM / FWTM 7.0° / 14.0°</p> <p>Efficiency 93 %</p> <p>Peak intensity 29.8 cd/lm</p> <p>LEDs/each optic 1</p> <p>Light colour White</p> <p>Required components:</p>		

#### OPTICAL RESULTS (SIMULATED):

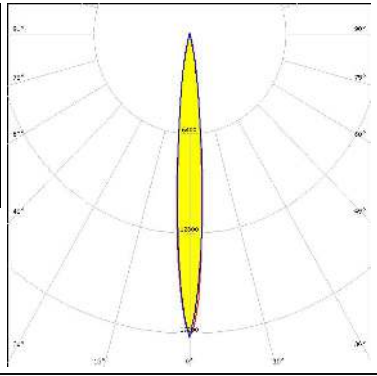
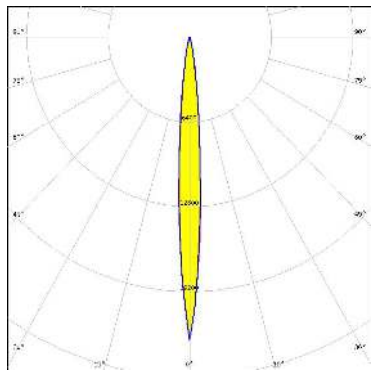
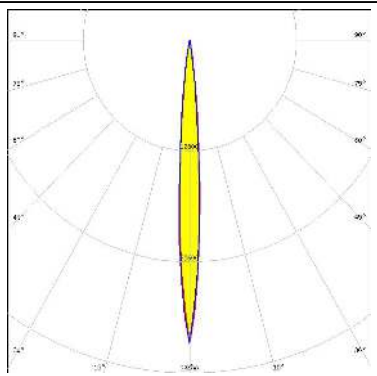
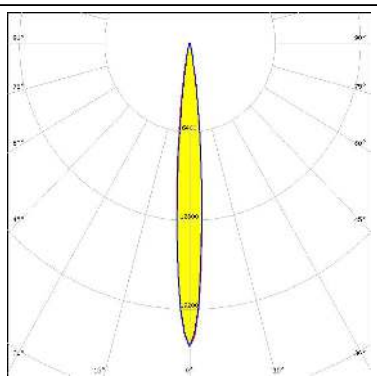
<p><b>CREE</b> LED</p> <p>LED: XT-E            FWHM / FWTM: 9.9° / 22.0°            Efficiency: 94 %            Peak intensity: 19.5 cd/lm            LEDs/each optic: 1            Light colour: White            Required components:</p>		
<p><b>LUMILEDS</b></p> <p>LED: LUXEON C            FWHM / FWTM: 8.0° / 20.0°            Efficiency: 94 %            Peak intensity: 22.9 cd/lm            LEDs/each optic: 1            Light colour: White            Required components:</p>		
<p><b>LUMILEDS</b></p> <p>LED: LUXEON CZ            FWHM / FWTM: 8.0° / 16.0°            Efficiency: 95 %            Peak intensity: 35 cd/lm            LEDs/each optic: 1            Light colour: Red            Required components:</p>		
<p><b>OSRAM</b>  <small>Opto Semiconductors</small></p> <p>LED: OSOLON Square CSSRM2/CSSRM3            FWHM / FWTM: 9.8° / 20.0°            Efficiency: 94 %            Peak intensity: 21.9 cd/lm            LEDs/each optic: 1            Light colour: White            Required components:</p>		

### OPTICAL RESULTS (SIMULATED):

#### SAMSUNG

LED LH351B  
 FWHM / FWTM 12.0° / 25.0°  
 Efficiency 94 %  
 Peak intensity 15 cd/lm  
 LEDs/each optic 1  
 Light colour White  
 Required components:

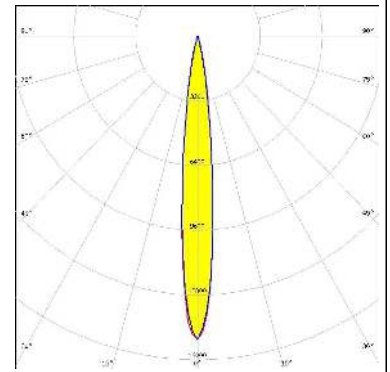

LED Z5M1/Z5M2  
 FWHM / FWTM 11.0° / 21.0°  
 Efficiency 94 %  
 Peak intensity 20.4 cd/lm  
 LEDs/each optic 1  
 Light colour White  
 Required components:

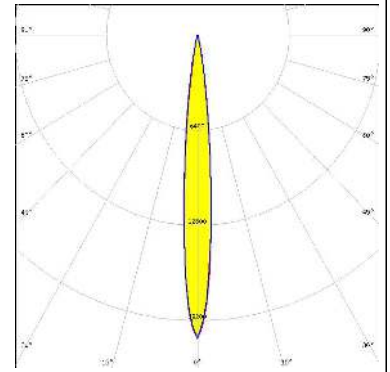

### GENERAL INFORMATION:

NOTE: The typical beam angle will be changed by different color, chip size and chip position tolerance. The typical total beam angle is the full angle measured where the luminous intensity is half of the peak value.

### MATERIALS:

As part of our continuous research and improvement processes, and to ensure the best possible quality and availability of our products, LEDiL reserves the right to change material grades without notice.

### PRODUCT DATA USER AGREEMENT AND DISCLAIMER:

The measured data in the provided downloadable LEDiL Product Datasheets and Mechanical 2D-Drawings is rounded and provided as reference for planning. LEDiL Oy's optical specifications have been verified by conducting performance testing of the products in accordance with the company's quality system. The reported data are averaged results of multiple measurements with typical variation. LEDiL Oy reserves the right to without prior notification make changes and improvements to its products.

LEDiL Oy assumes neither warranty, nor guarantee nor any other liability of any kind for the contents and correctness of the provided data. The provided data has been generated with highest diligence but the provided data may in reality not represent the complete possible variation range of all intrinsic parameters. Therefore, in certain cases a deviation from the provided data could occur.

LEDiL Oy reserves the right to undertake technical changes of its products without further notification which could lead to changes in the provided data. LEDiL Oy assumes no liability of any kind for the possible deviation from any provided data or any other damage resulting from the usage of the provided data.

The user agrees to this disclaimer and user agreement with the download or usage of the provided files.

#### LEDiL Oy

Joensuunkatu 13  
FI-24240 SALO  
Finland

#### LEDiL Inc.

228 West Page Street  
Suite D  
Sycamore IL 60178  
USA

#### Ledil Optics Technology (Shenzhen) Co., Ltd.

# 405 , Block B  
Casic Motor Building  
Shenzhen 518057  
P.R.CHINA

#### Local sales and technical support

[www.ledil.com/  
where\\_to\\_buy](http://www.ledil.com/where_to_buy)

#### Shipping locations

Salo, Finland  
Hong Kong, China

#### Distribution Partners

[www.ledil.com/  
where\\_to\\_buy](http://www.ledil.com/where_to_buy)