

Device Features

- Gain = 17.5 dB @ 3500MHz
- OIP3 = 37.5 dBm @ 3500MHz
- Output P1 dB = 19.6 dBm @ 3500 MHz
- N.F = 1.5dB @ 3500MHz
- Internally matched to 50 ohms
- RoHS2-compliant SOT-89 SMT package



Product Description

The BNT02 is a BroadBand, GaAs E-pHEMT Amplifier that is ideal for applications demanding high linearity & Low Noise Figure in a wideband of 40-6000 MHz. The BNT02 is internally matched to 50 Ohms. It is available in RoHS2-compliant SOT-89 SMT package. These devices are 100% DC and RF tested to assure quality and performance.

Applications

- Repeaters
- Mobile Infrastructure
- Defense/Aerospace
- LTE / WCDMA / EDGE / CDMA / 5G NR
- General Purpose Wireless
- IF amplifier, RF driver amplifier

Applications Circuit

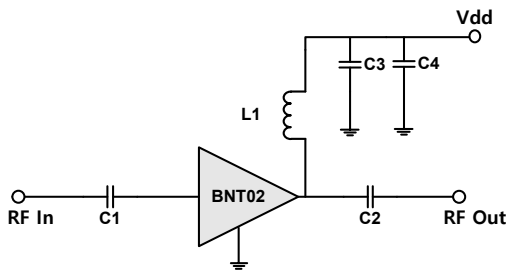

BOM	70MHz	900MHz	1.8GHz	2.65GHz	3.5GHz
C1	10nF	200pF	4.7pF	3.5pF	47pF
C2	10nF	200pF	200pF	3.5pF	1pF
C3	100pF	100pF	100pF	100pF	100pF
C4	1uF	1uF	1uF	1uF	1uF
L1	820nH	33nH	3.3nH	5.6nH	22nH

Electrical Specifications

Device performance _ measured on a BeRex evaluation board at 25°C, Vd=5V, 50 Ω system.

Parameter	Conditions	Min	Typ	Max	Unit
Operational Frequency Range		40		6000	MHz
Test Frequency			3500		MHz
Gain		16.0	17.5		dB
Input Return Loss			13.2		dB
Output Return Loss			12.5		dB
Output IP3	5 dBm / tone , Δf=1 MHz	34.5	37.5		dBm
Output P1dB		18.6	19.6		dBm
Noise Figure			1.5	1.7	dB

* N.F : Losses on input and output transmission lines on PCB are not de-embedded.

Device performance _ measured on a BeRex evaluation board at 25°C, Vd=3.3V, 50 Ω system.

Parameter	Conditions	Min	Typ	Max	Unit
Operational Frequency Range		40		6000	MHz
Test Frequency			3500		MHz
Gain		15.2	16.7		dB
Input Return Loss			11.6		dB
Output Return Loss			10.8		dB
Output IP3	5 dBm / tone , Δf=1 MHz	28.1	31.1		dBm
Output P1dB		15.0	16.0		dBm
Noise Figure			1.5	1.7	dB

* N.F : Losses on input and output transmission lines on PCB are not de-embedded.

Recommended Operating Conditions

Parameter	Min	Typ	Max	Unit
Bandwidth	40		6000	MHz
I _d @ (V _d = 5.0V)	68	85	102	mA
I _d @ (V _d = 3.3V)	39	48	57	mA
V _d	3.3	5	5.25	V
dG/dT		0.006		dB/°C
R _{TH}		49.4		°C/W
Operating Case Temperature	-40		+105	°C

Electrical specifications are measured at specified test conditions.

Specifications are not guaranteed over all recommended operating conditions.

Absolute Maximum Ratings

Parameter	Rating	Unit
Storage Temperature	-55 to +155	°C
Junction Temperature	+170	°C
Supply Voltage	+7	V
Supply Current	190	mA
Input RF Power	20	dBm

Operation of this device above any of these parameters may result in permanent damage.

Typical RF Performance (Vd=5V, Id=85mA, T=25°C)

Parameter	Frequency								Unit
	70	900	1800	2140	2650	3500	4650	5800	MHz
Gain	21.7	20.8	19.8	19.3	18.8	17.5	17.3	14.7	dB
S11	13.5	16.0	23.1	24.5	15.0	13.2	17.3	7.1	dB
S22	21.4	21.1	22.6	20.3	26.3	12.5	18.0	5.1	dB
OIP3	38.6	38.0	37.6	37.7	38.1	37.5	37.1	32.1	dBm
P1dB	22.0	22.3	21.7	21.8	21.8	19.6	18.9	17.2	dBm
LTE 20M ACLR*	13.1	13.1	12.1	12.3	12.2	9.8	9.2	7.6	dBm
5G NR ACLR*	-	-	-	-	-	9.6	8.8	-	dBm
Noise Figure	0.9	1.0	1.1	1.1	1.2	1.5	1.9	2.2	dB

Typical RF Performance (Vd=3.3V, Id=48mA, T=25°C)

Parameter	Frequency								Unit
	70	900	1800	2140	2650	3500	4650	5800	MHz
Gain	21.2	20.3	19.3	18.8	18.2	16.7	16.6	13.6	dB
S11	12.2	14.3	18.8	20.9	13.7	11.6	14.9	6.3	dB
S22	18.0	19.0	32.0	18.1	20.1	10.8	14.8	4.6	dB
OIP3	33.1	32.3	33.9	33.0	33.1	31.1	29.2	23.8	dBm
P1dB	18.5	18.3	17.8	18.2	18.0	16.0	15.4	13.3	dBm
LTE 20M ACLR*	8.6	8.5	8.2	8.2	8.1	6.1	5.1	1.9	dBm
5G NR ACLR*	-	-	-	-	-	5.8	4.8	-	dBm
Noise Figure	0.8	0.9	1.1	1.1	1.2	1.5	1.8	2.0	dB

*ACLR Channel Power measured at -50dBc.

- LTE set-up: 3GPP LTE, FDD E-TM3.1, 20MHz BW, ±20MHz offset, PAR 9.75 at 0.01% Prob.

- 5G NR Downlink FR1 : SCS 30KHz, CBW 100MHz, 256QAM, PAR 9.66 at 0.01% Prob.

* N.F : Losses on input and output transmission lines on PCB are not de-embedded.

V-I Characteristics

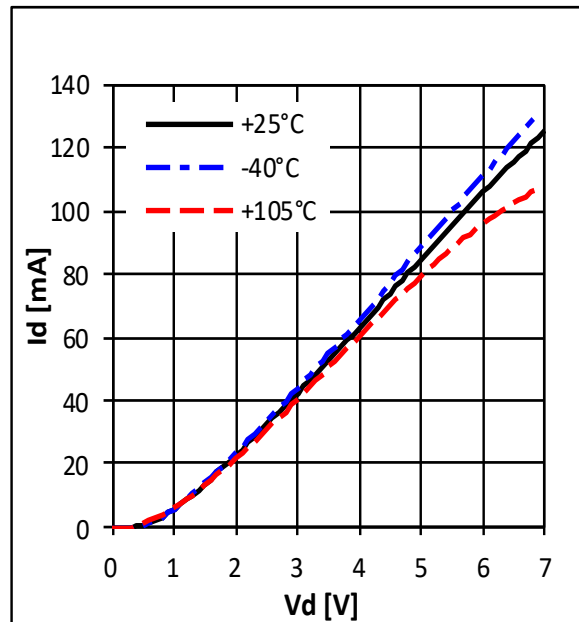

BeRex SOT89 Evaluation Board

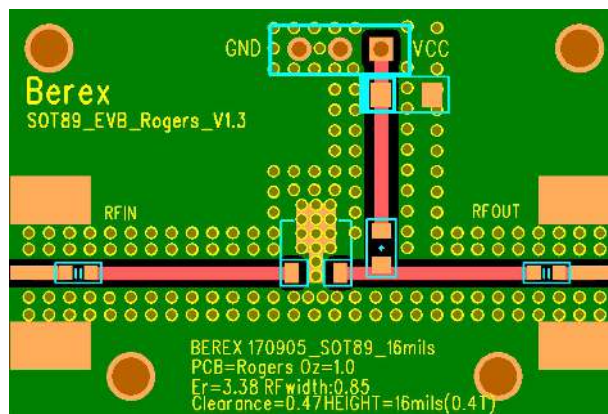

*Dielectric constant _3.38 *RF pattern width 0.85T *16mils thick RO4003C PCB

Typical Device Data

S-parameters (Vd=5V, Id=85mA, T=25°C)

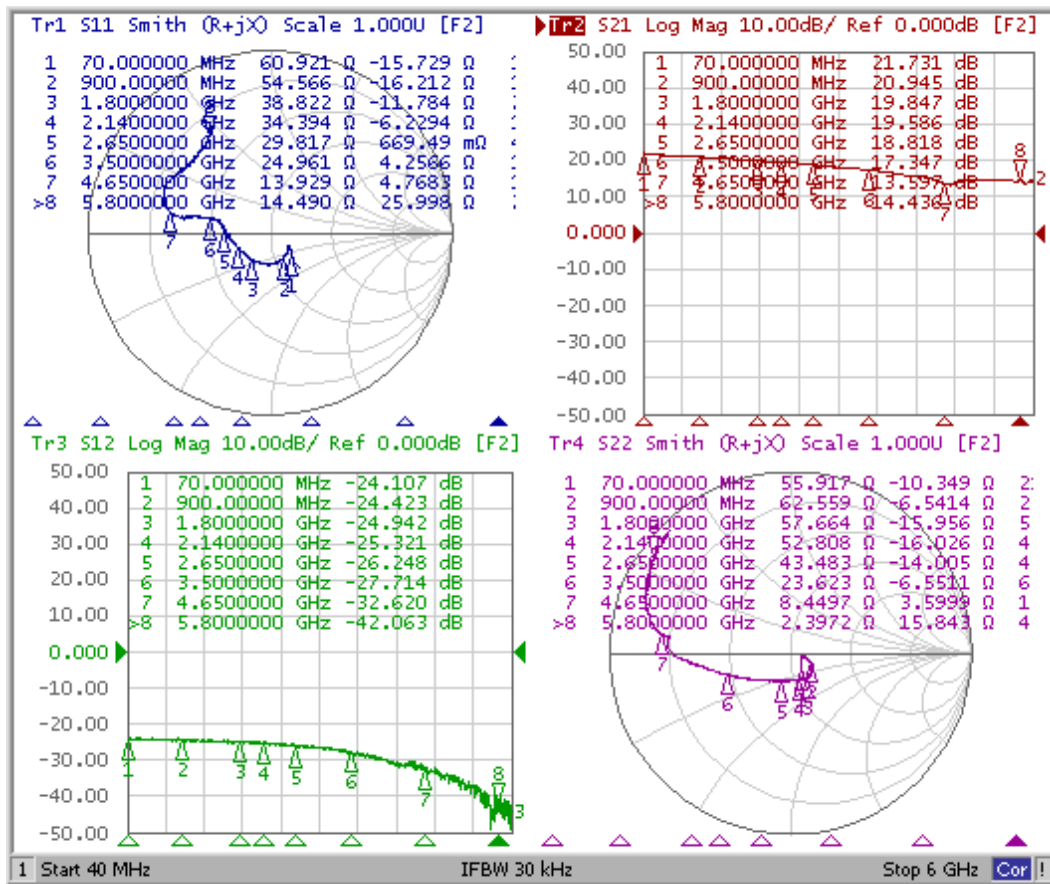

S-Parameter

(Vdevice = 5.0V, Id = 85mA, T = 25 °C, calibrated to device leads)

Freq [MHz]	S11	S11	S21	S21	S12	S12	S22	S22
	[Mag]	[Ang]	[Mag]	[Ang]	[Mag]	[Ang]	[Mag]	[Ang]
200	0.126	-35.333	11.904	168.129	0.062	-1.391	0.07	-30.167
400	0.128	-39.713	11.778	159.731	0.061	-6.013	0.075	-16.391
1200	0.17	-81.692	10.749	124.242	0.058	-21.365	0.15	-35.025
2000	0.186	-143.027	9.62	92.135	0.056	-34.761	0.159	-63.606
2800	0.27	174.103	8.408	58.778	0.047	-55.355	0.178	-118.58
3600	0.352	166.571	7.128	27.29	0.039	-69.352	0.406	-164.136
4400	0.458	169.183	5.704	-2.99	0.03	-84.599	0.677	172.536
5200	0.591	140.703	5.221	-20.561	0.015	-114.04	0.815	164.369
6000	0.779	115.236	5.353	-48.558	0.007	134.017	0.943	134.816

Typical Device Data

S-parameters (Vd=3.3V, Id=48mA, T=25°C)

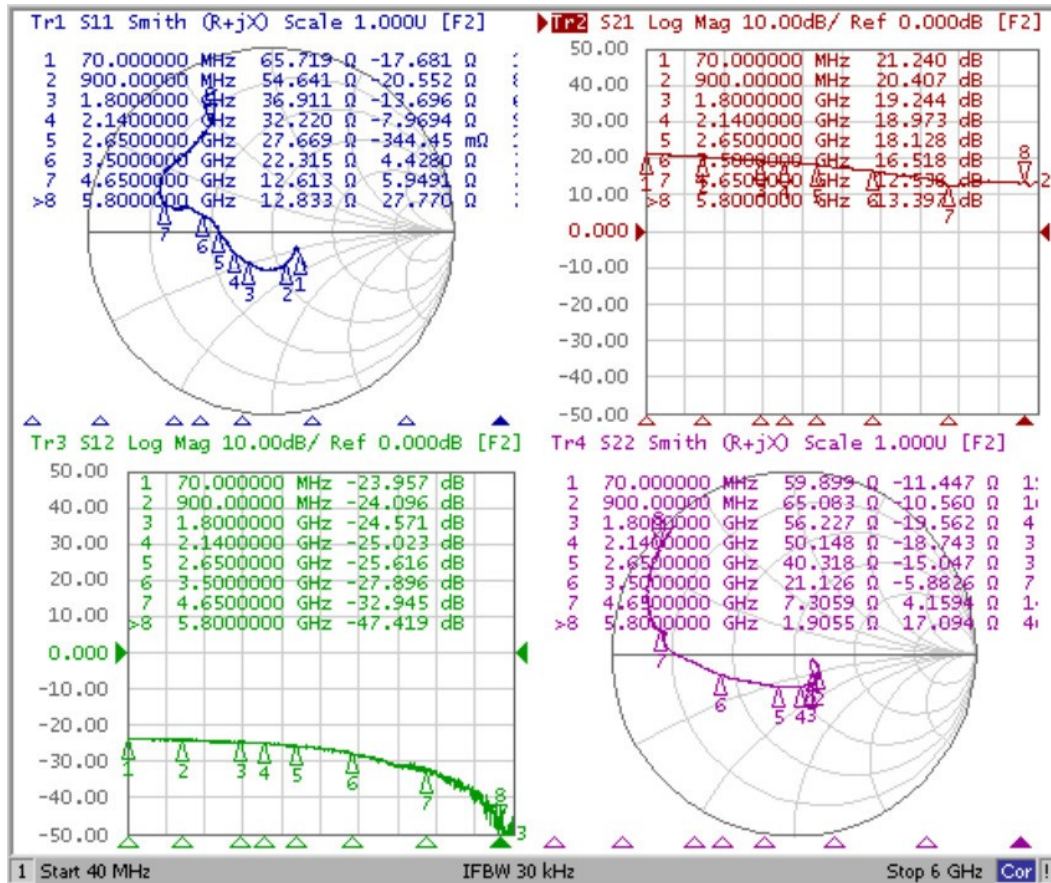

S-Parameter

(Vdevice = 3.3V, Id = 48mA, T = 25 °C, calibrated to device leads)

Freq [MHz]	S11 [Mag]	S11 [Ang]	S21 [Mag]	S21 [Ang]	S12 [Mag]	S12 [Ang]	S22 [Mag]	S22 [Ang]
	200	0.163	-30.786	11.297	167.965	0.064	-0.788	0.101
400	0.164	-36.74	11.12	159.148	0.063	-6.554	0.107	-17.148
1200	0.207	-82.124	10.084	122.768	0.061	-20.831	0.182	-39.737
2000	0.227	-141.511	8.992	89.973	0.057	-36.861	0.186	-70.458
2800	0.301	175.938	7.745	55.633	0.05	-53.928	0.213	-124.602
3600	0.398	166.442	6.462	23.896	0.04	-72.002	0.448	-166.602
4400	0.494	165.183	5.074	-6.266	0.027	-83.593	0.711	170.874
5200	0.635	137.622	4.687	-23.836	0.013	-111.684	0.838	162.243
6000	0.828	111.716	4.78	-51.953	0.002	136.153	0.956	132.358

Application Circuit: 70 MHz

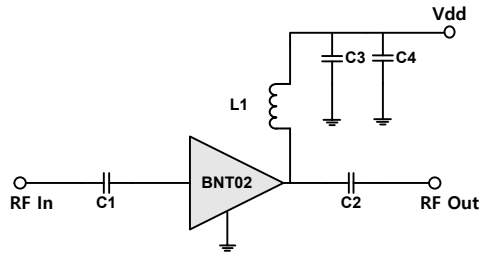
Schematic Diagram		BOM		Tolerance
		C1	10nF	± 5%
		C2	10nF	± 5%
		C3	100pF	± 5%
		C4	1uF	± 10%
		L1	820nH	± 5%

Typical Performance

$V_d = 5V, I_d = 85mA$

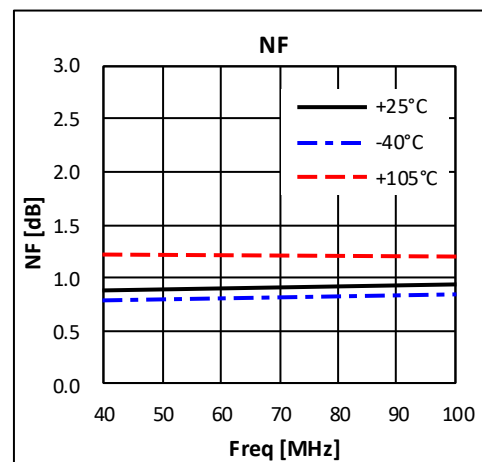
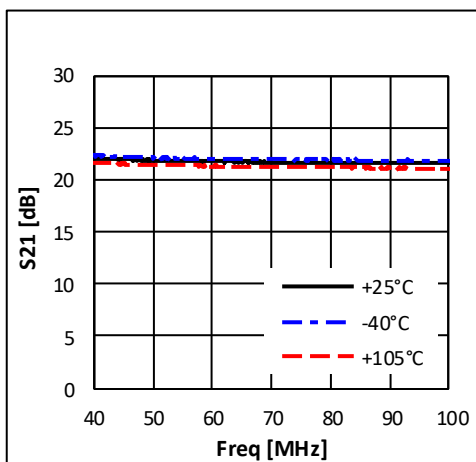
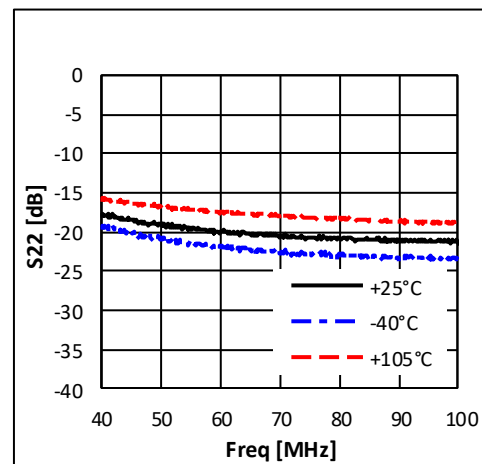
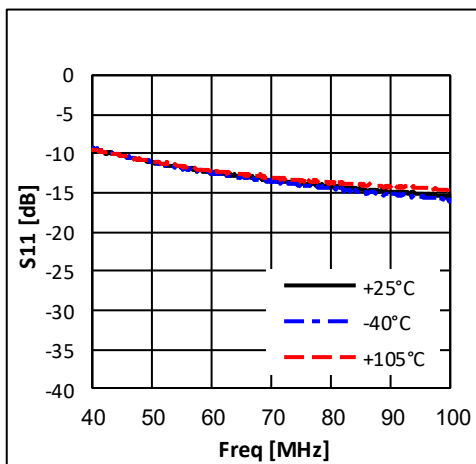

$V_d = 5V, I_d = 85mA$

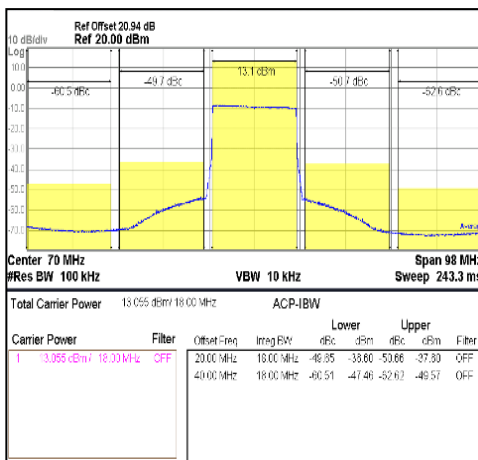
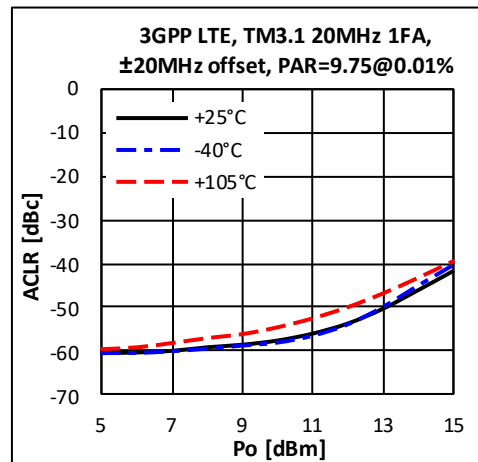
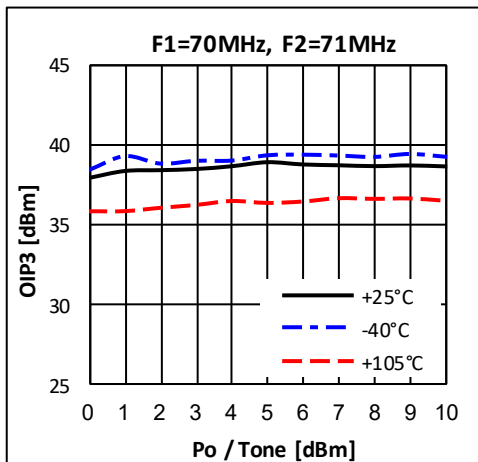
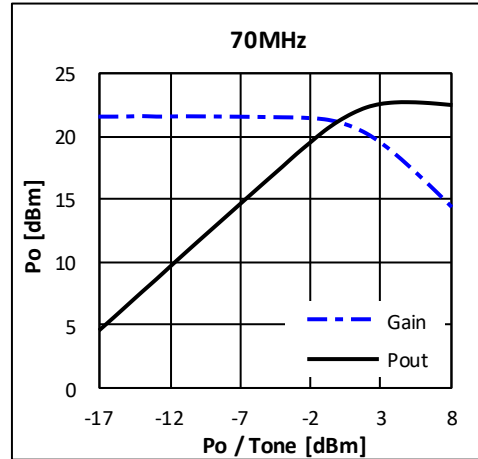
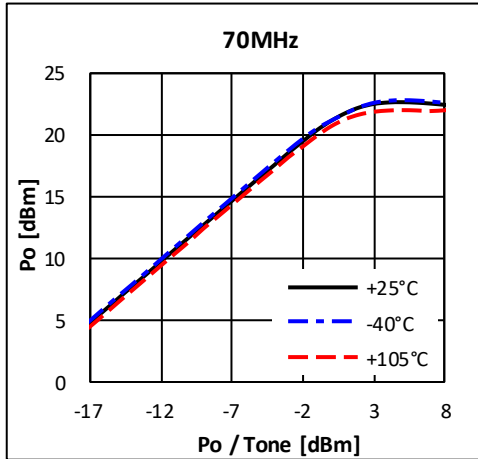

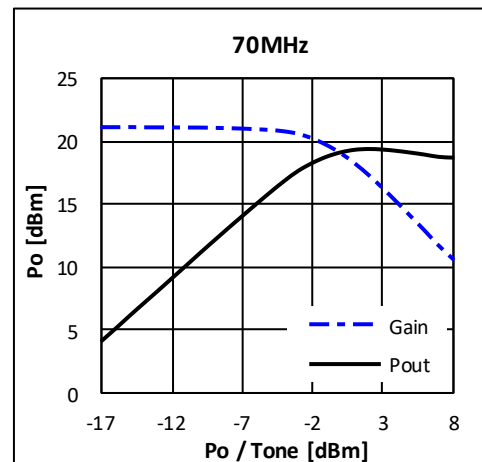
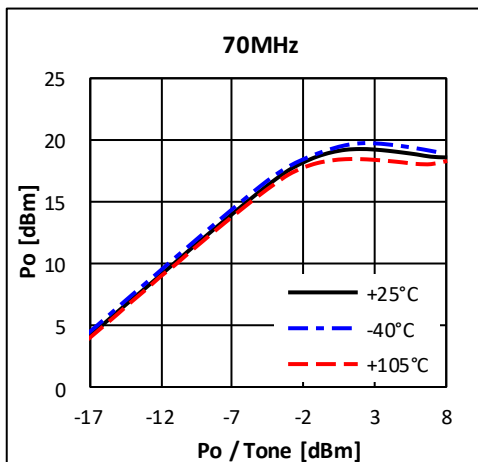
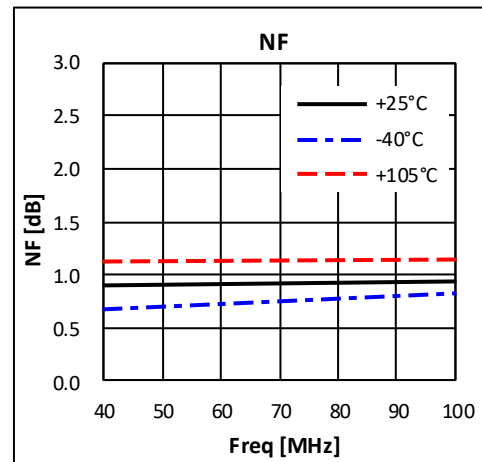
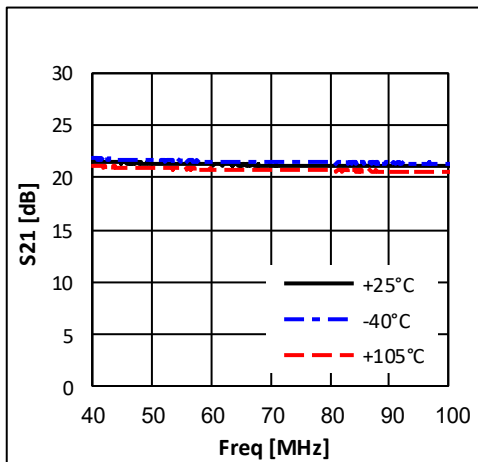
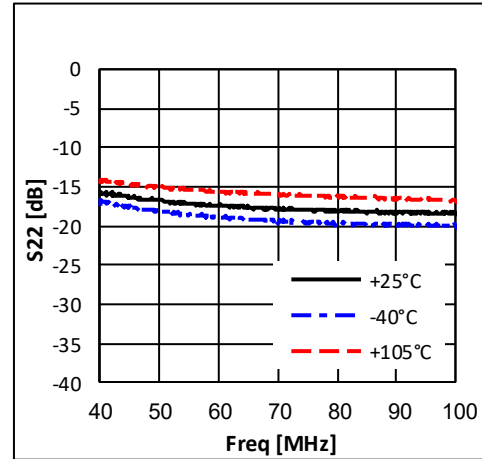
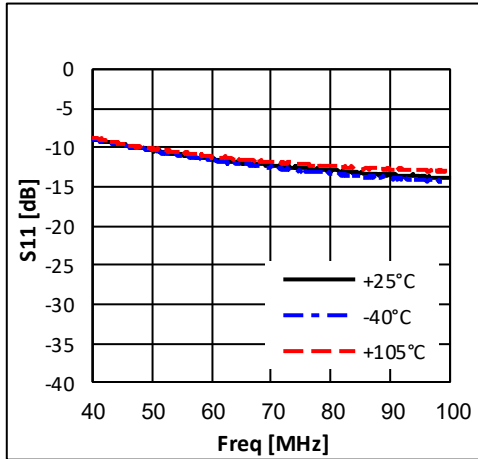
$V_d = 3.3V, I_d = 48mA$

$V_d = 3.3V, I_d = 48mA$

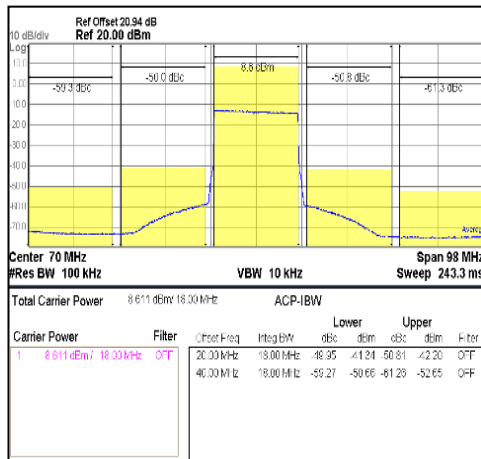
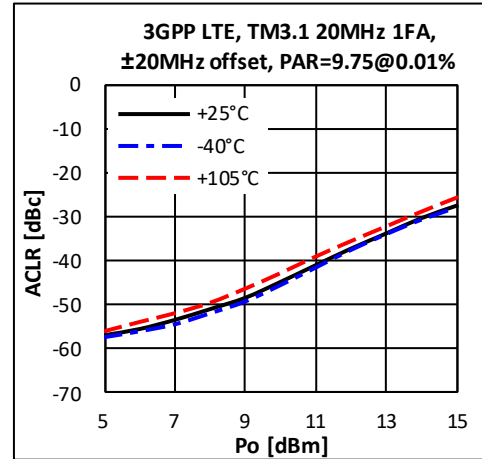
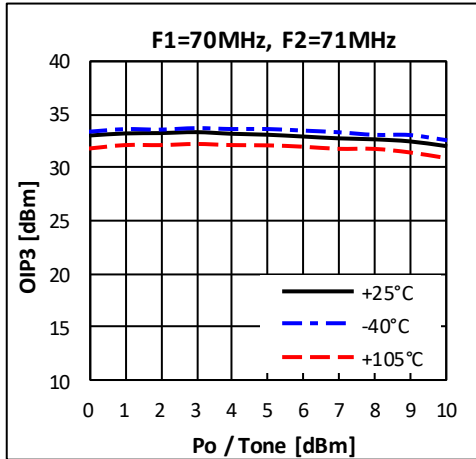

Application Circuit: 900MHz

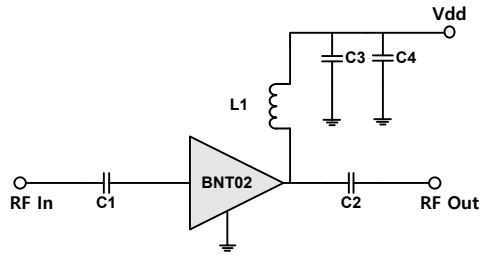
Schematic Diagram		BOM	Tolerance
	C1	200pF	± 5%
	C2	200pF	± 5%
	C3	100pF	± 5%
	C4	1uF	± 10%
	L1	33nH	± 5%

Typical Performance

$V_d = 5V, I_d = 85mA$

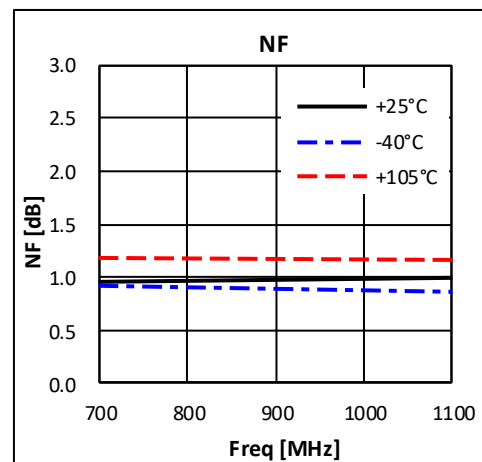
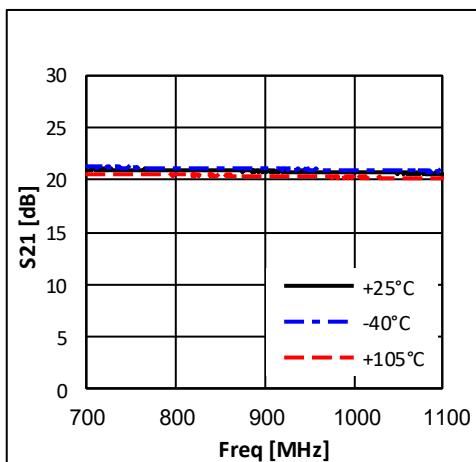
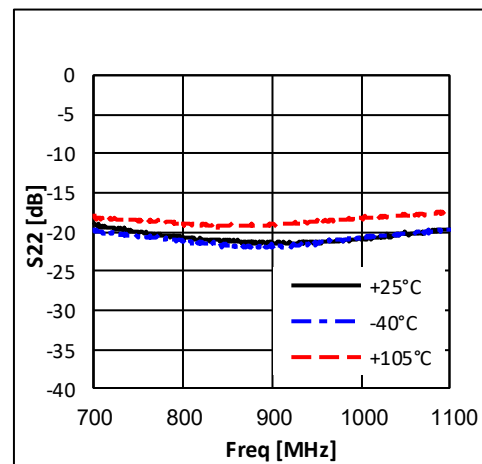
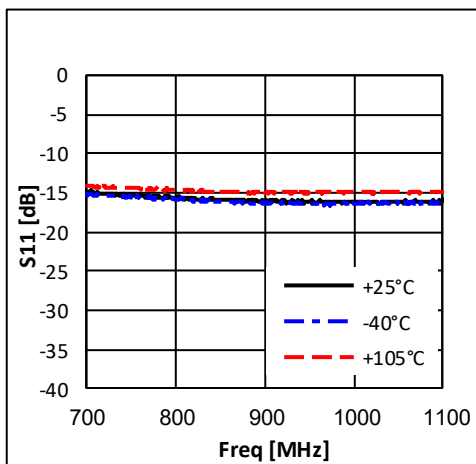

$V_d = 5V, I_d = 85mA$

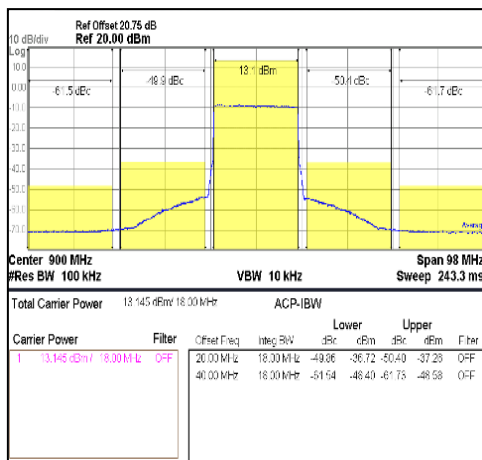
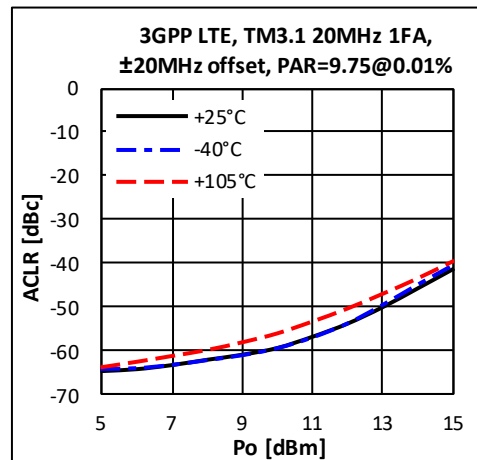
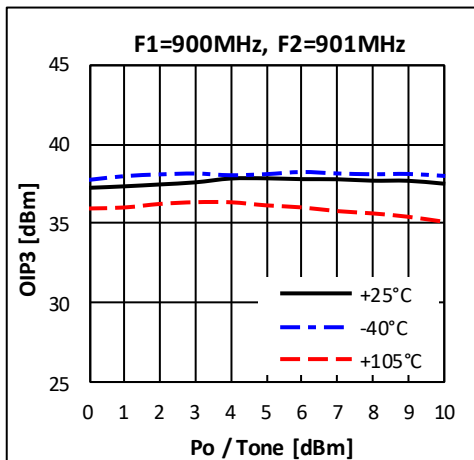
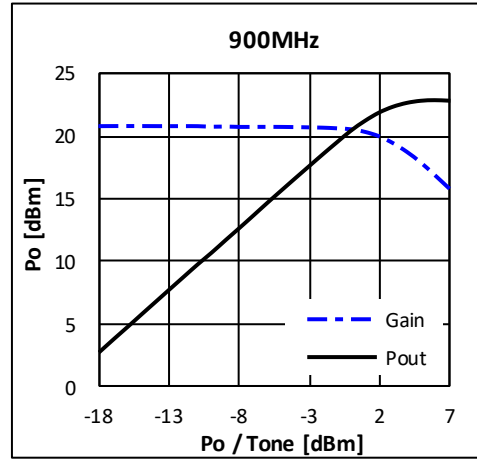
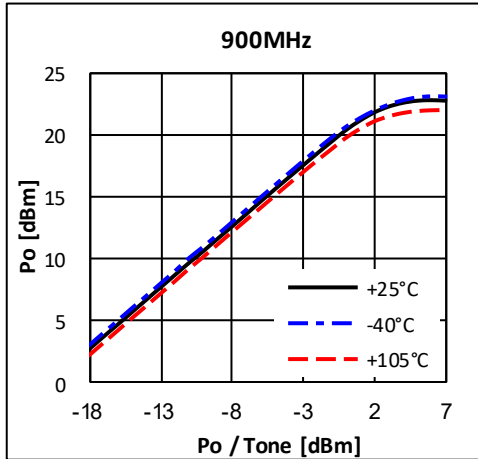

$V_d = 3.3V, I_d = 48mA$

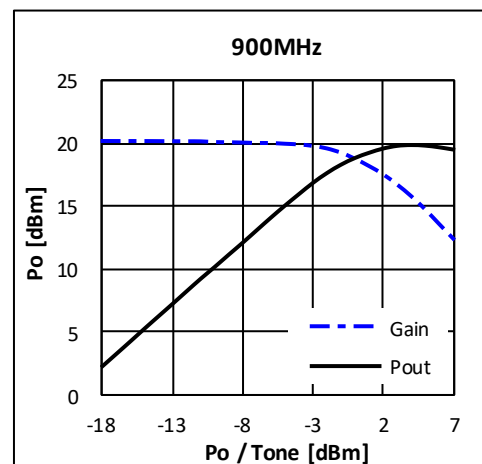
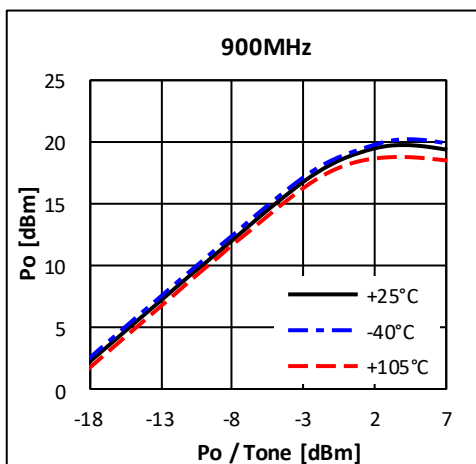
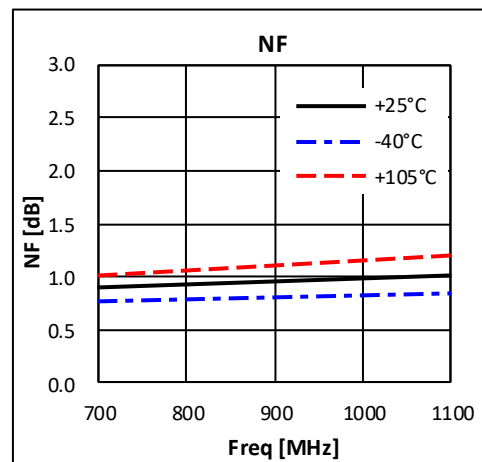
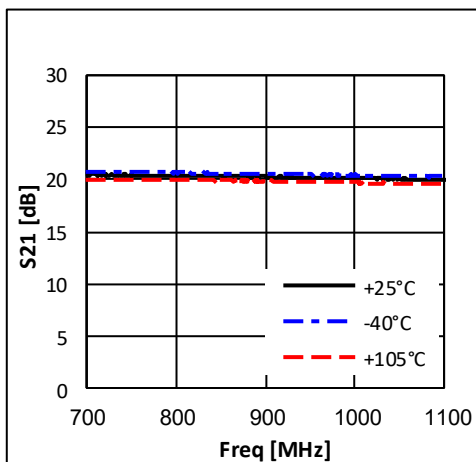
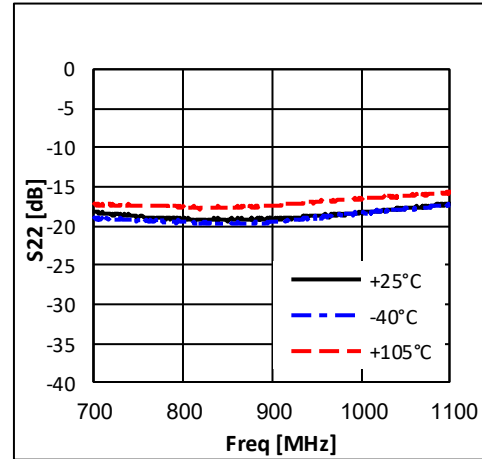
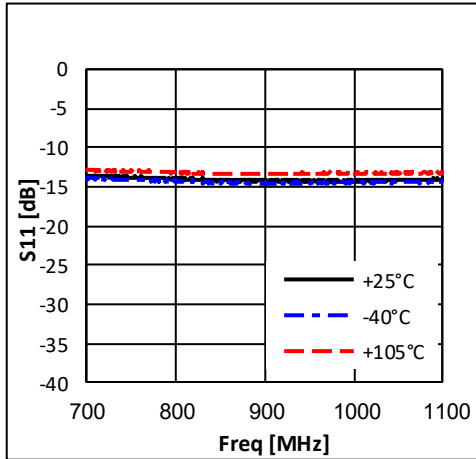

$V_d = 3.3V, I_d = 48mA$

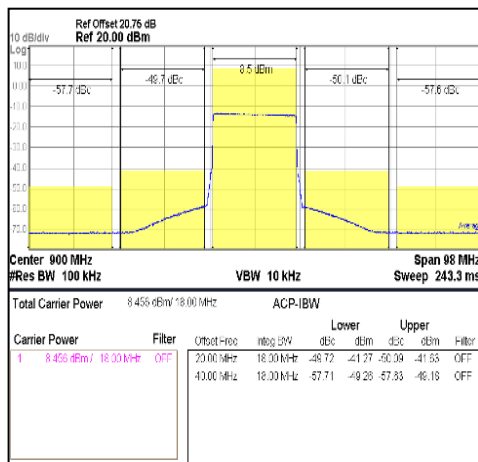
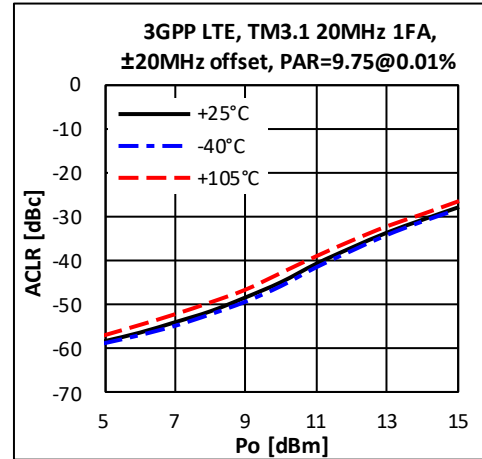
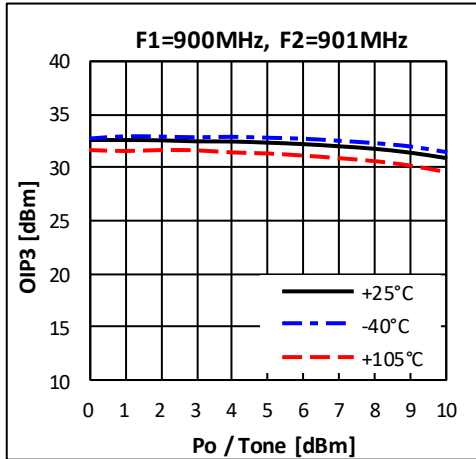

Application Circuit: 1800 MHz

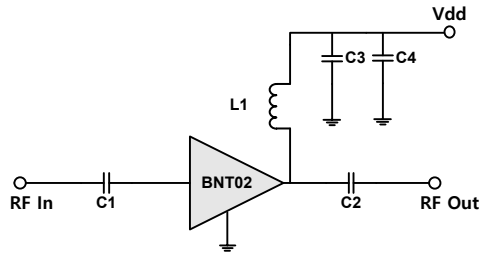
Schematic Diagram		BOM	Tolerance
	C1	4.7pF	± 5%
	C2	200pF	± 5%
	C3	100pF	± 5%
	C4	1uF	± 10%
	L1	3.3nH	± 5%

Typical Performance

$V_d = 5V, I_d = 85mA$

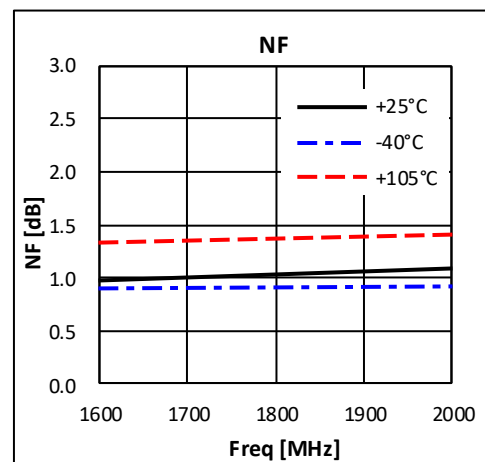
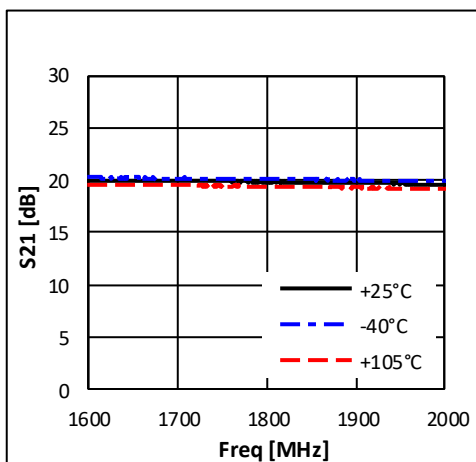
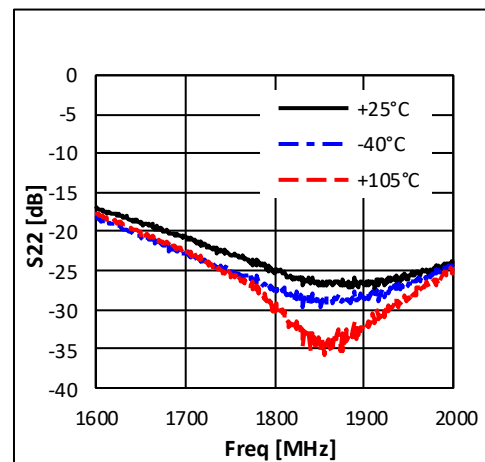
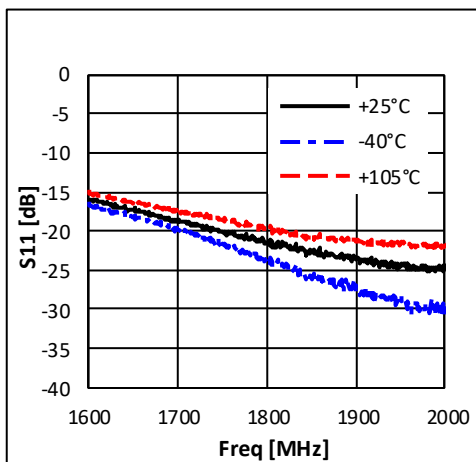

$V_d = 5V, I_d = 85mA$

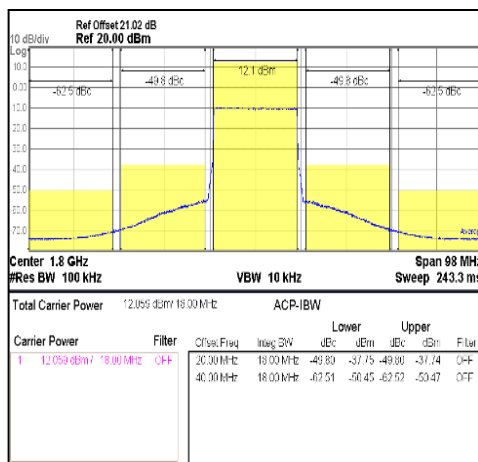
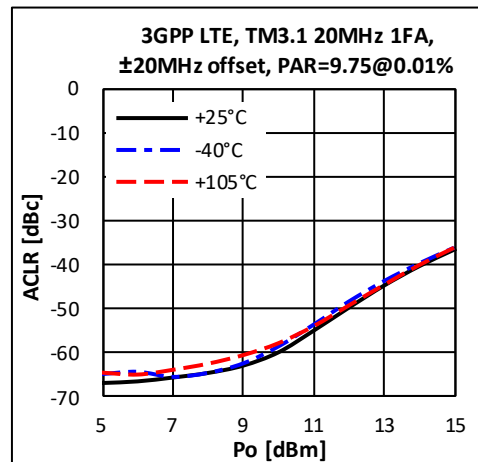
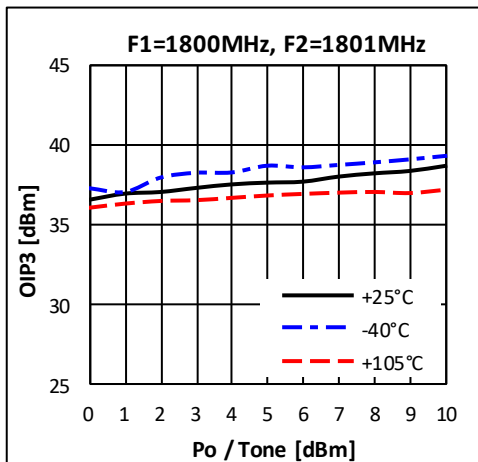
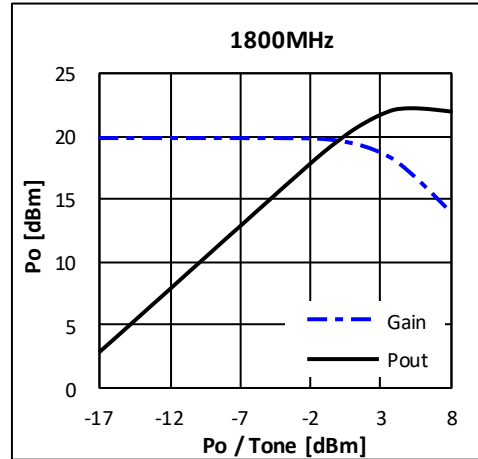
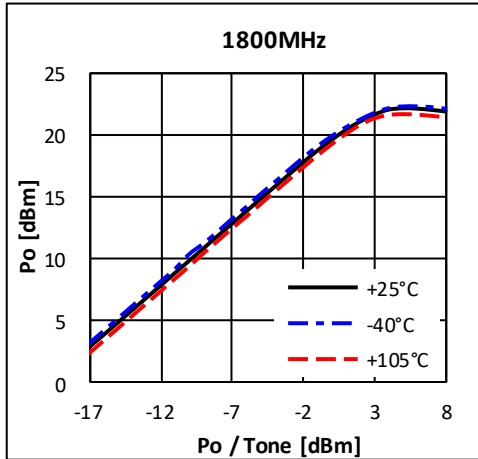

$V_d = 3.3V, I_d = 48mA$

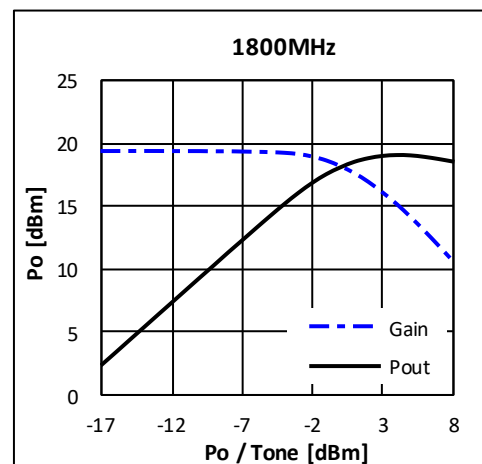
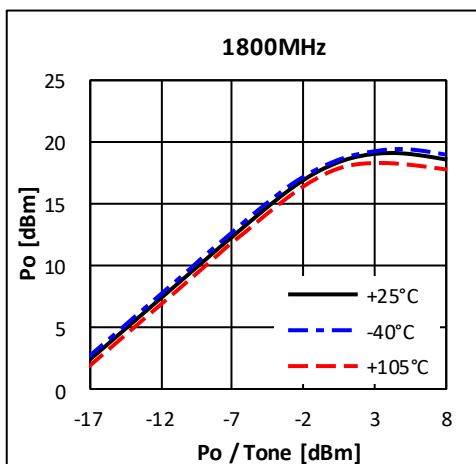
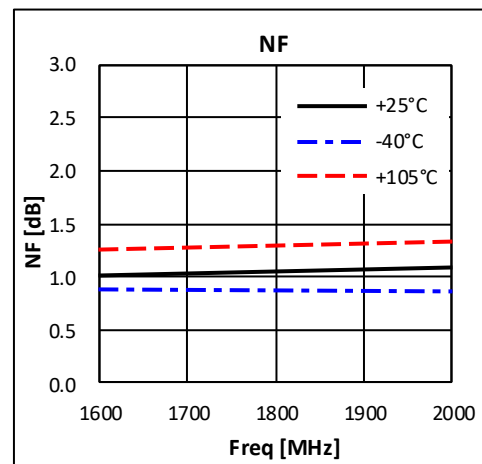
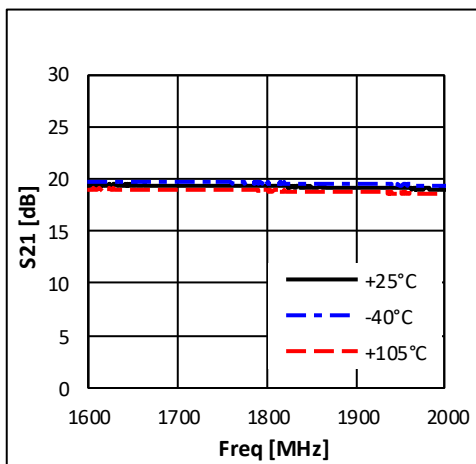
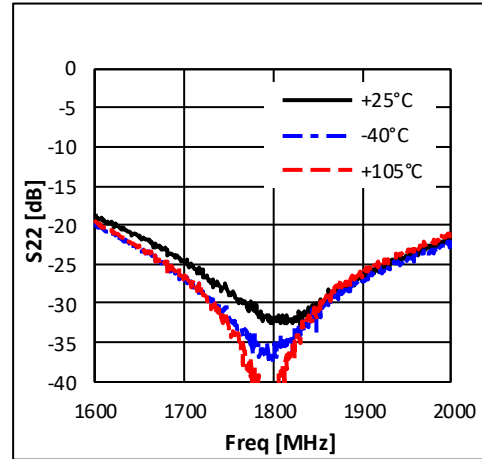
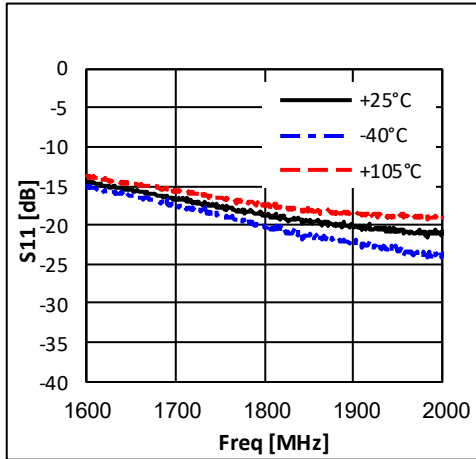

$V_d = 3.3V, I_d = 48mA$

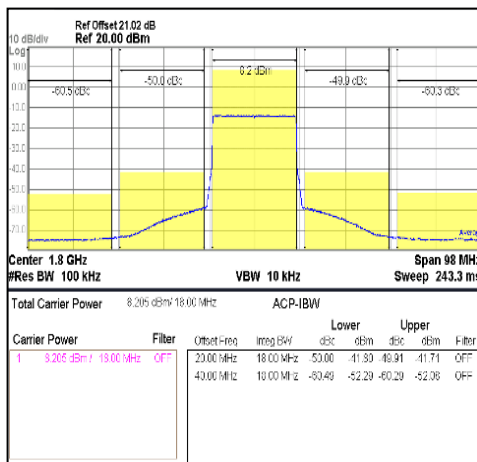
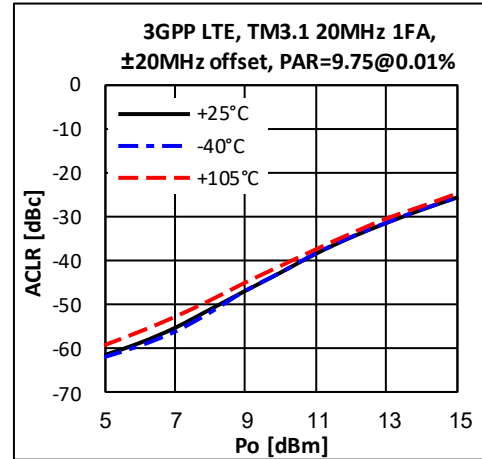
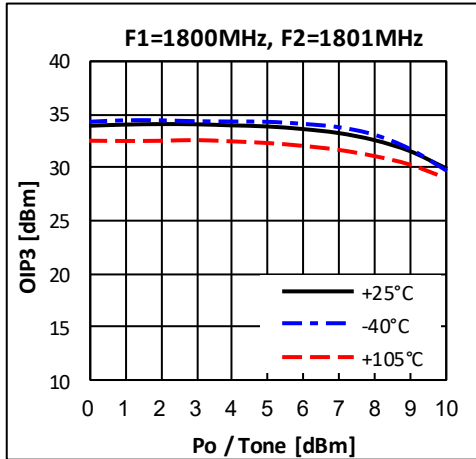

Application Circuit: 2140 MHz

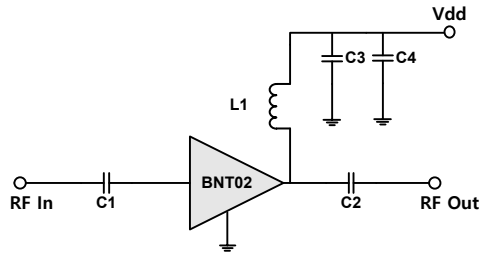
Schematic Diagram		BOM	Tolerance	
		C1	4.7pF	± 5%
		C2	200pF	± 5%
		C3	100pF	± 5%
		C4	1uF	± 10%
		L1	3.3nH	± 5%

Typical Performance

$V_d = 5V, I_d = 85mA$

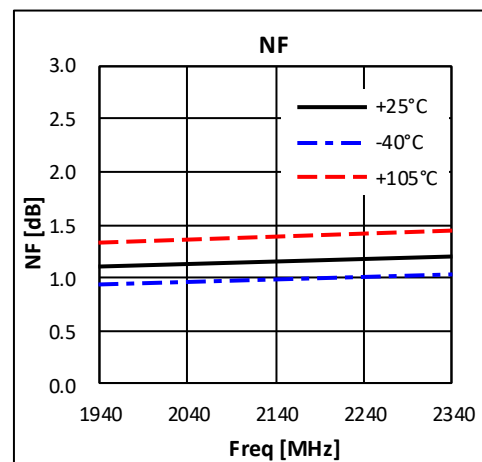
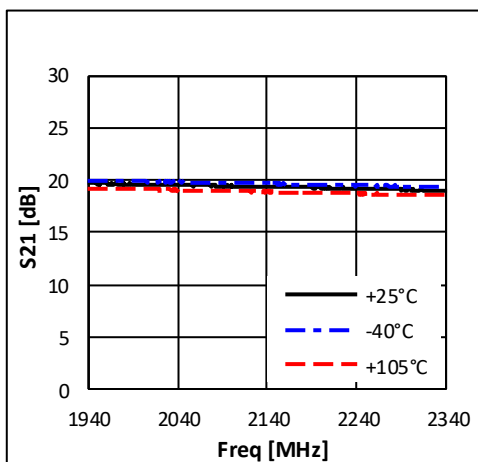
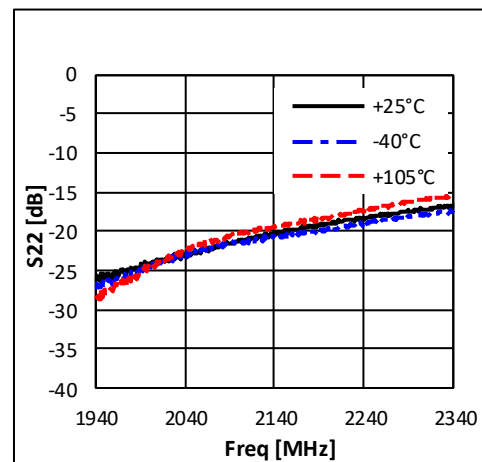
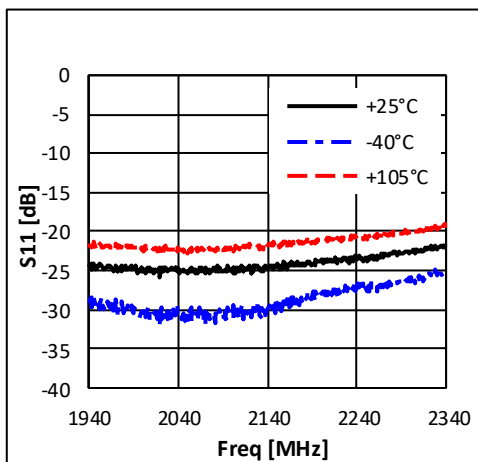

$V_d = 5V, I_d = 85mA$

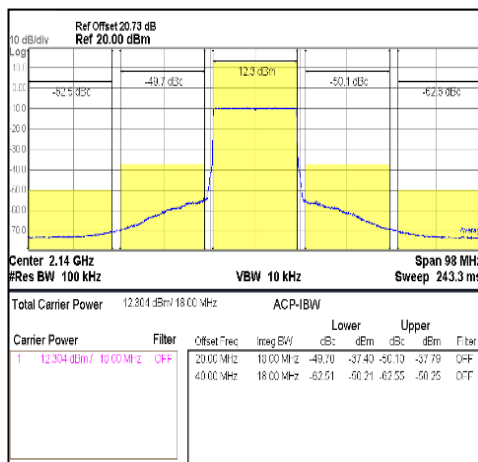
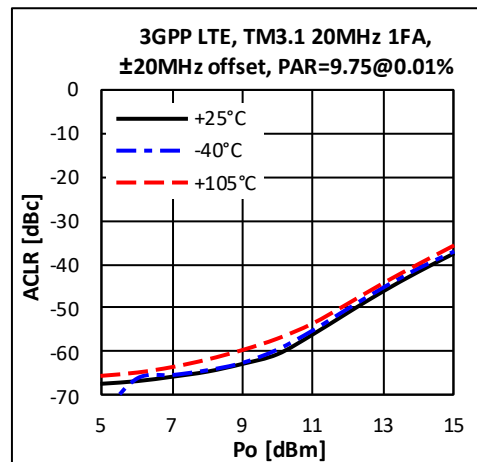
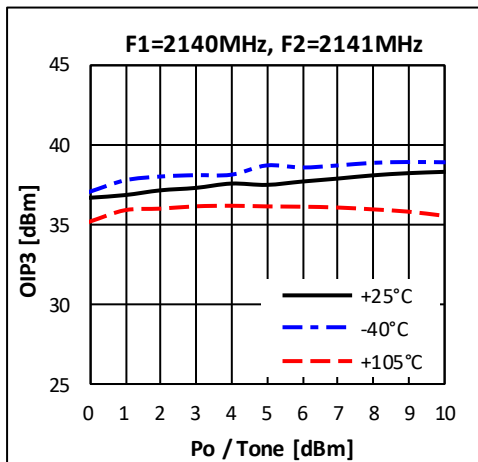
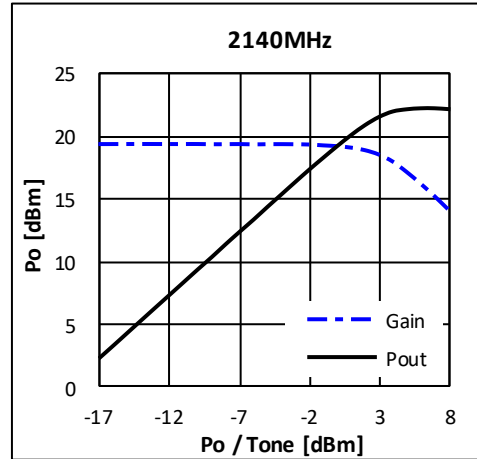
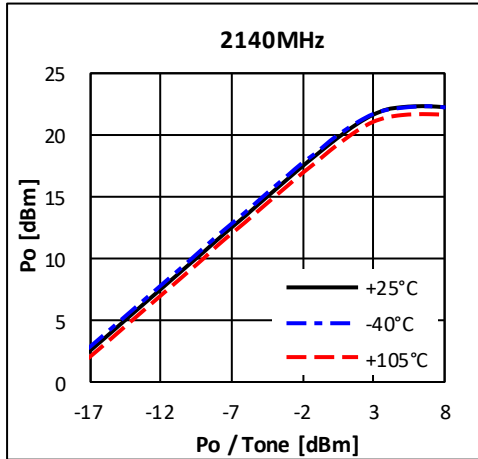

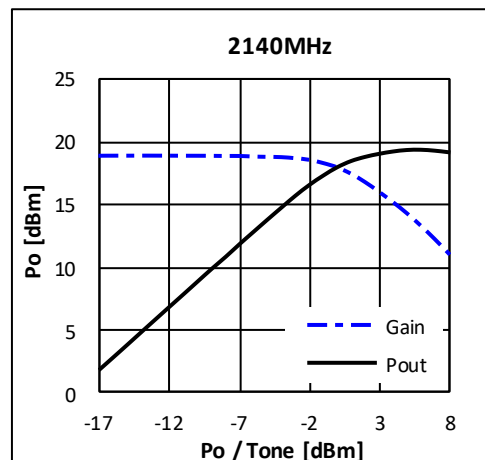
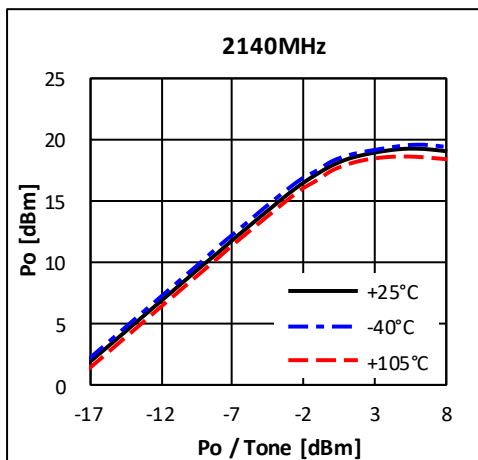
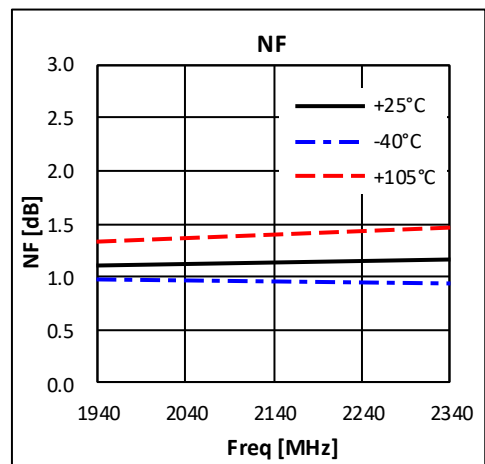
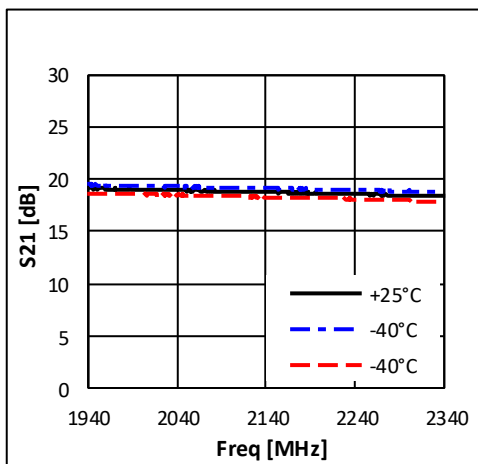
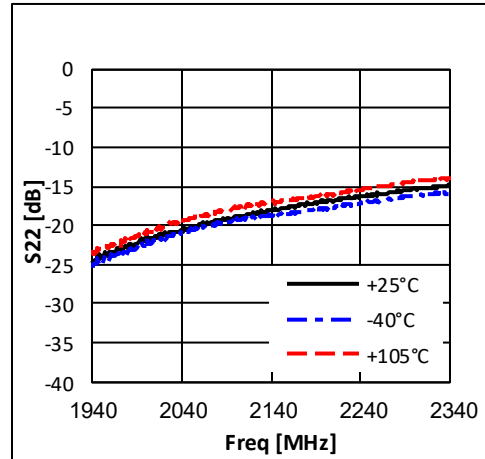
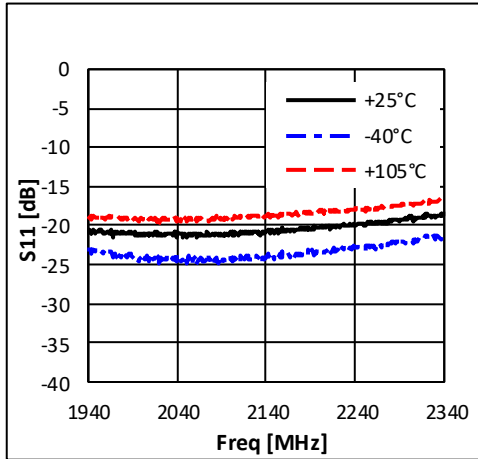
$V_d = 3.3V, I_d = 48mA$

$V_d = 3.3V, I_d = 48mA$

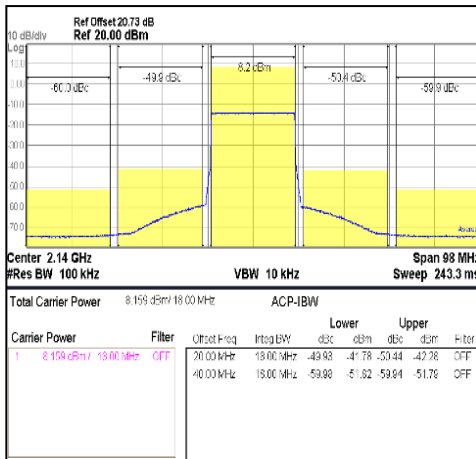
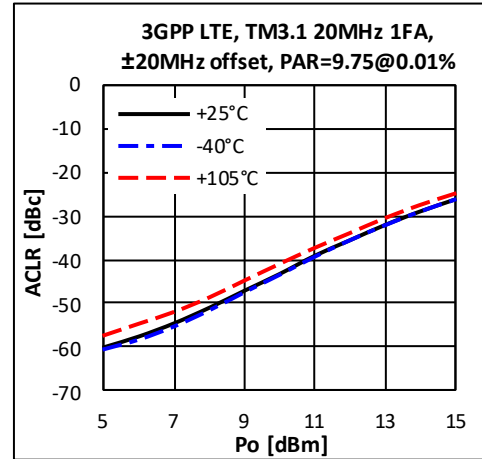
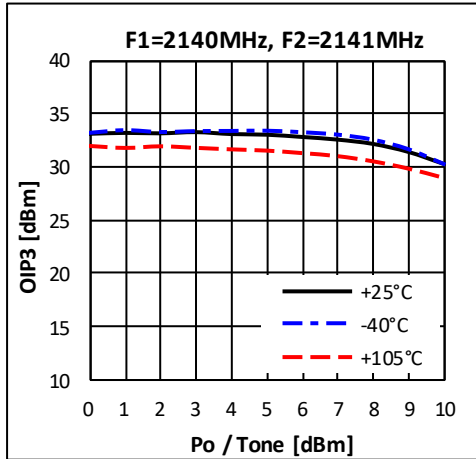

Application Circuit: 2650 MHz

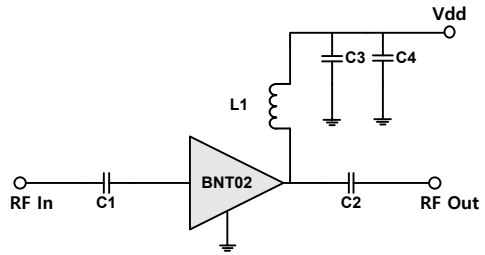
Schematic Diagram		BOM	Tolerance
	C1	3.5pF	± 5%
	C2	3.5pF	± 5%
	C3	100pF	± 5%
	C4	1uF	± 10%
	L1	5.6nH	± 5%

Typical Performance

$V_d = 5V, I_d = 85mA$

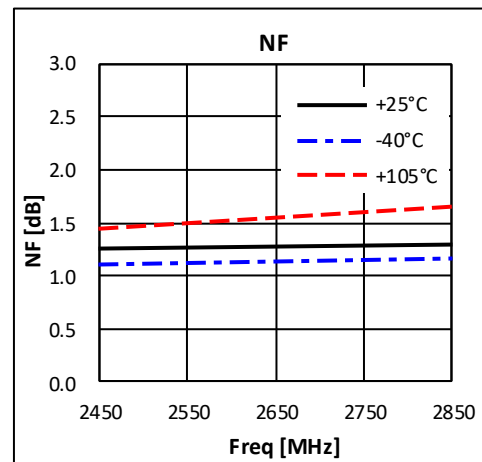
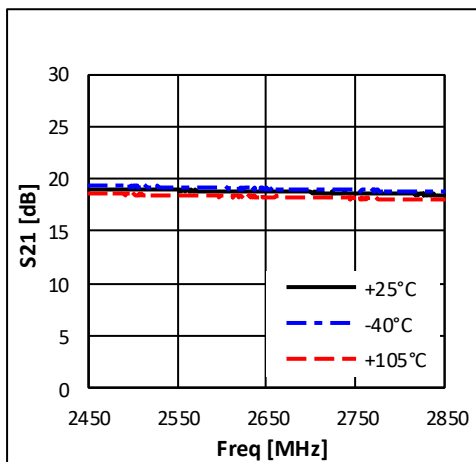
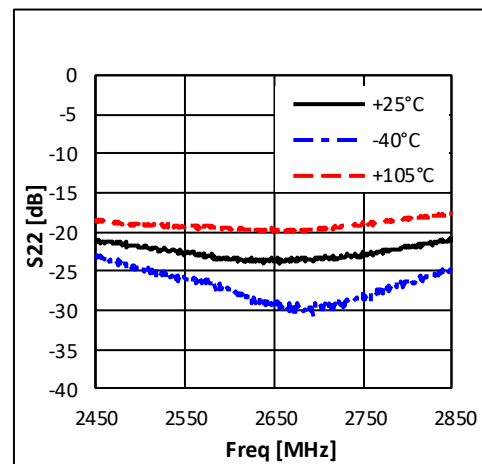
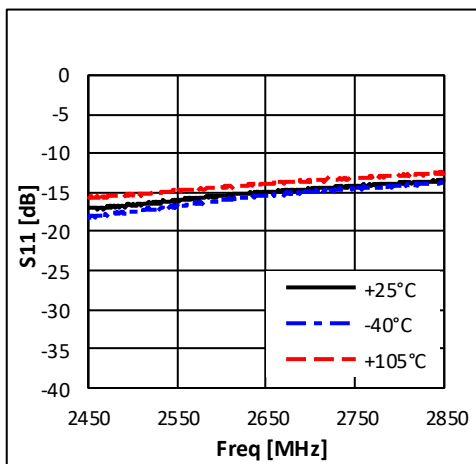

$V_d = 5V, I_d = 85mA$

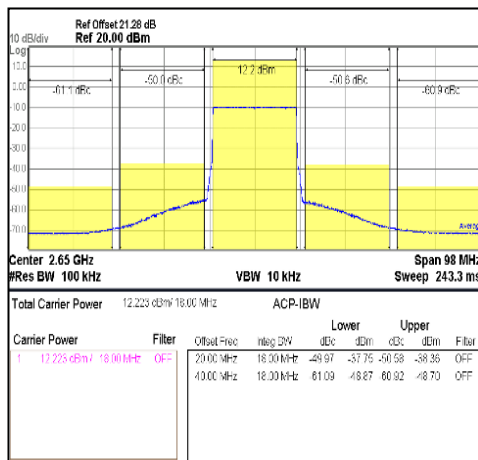
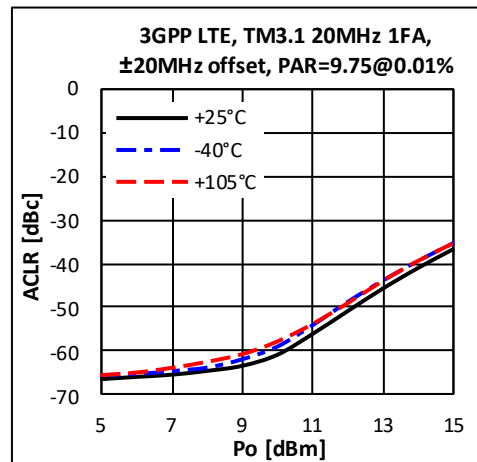
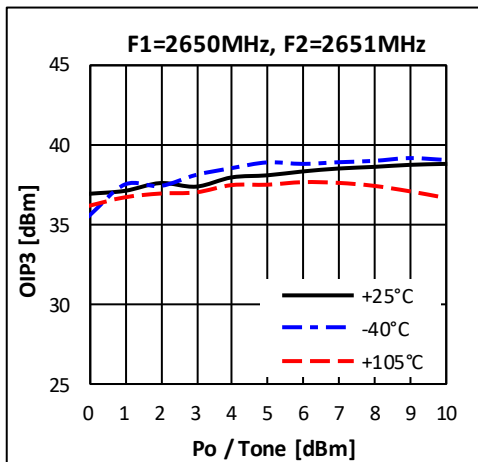
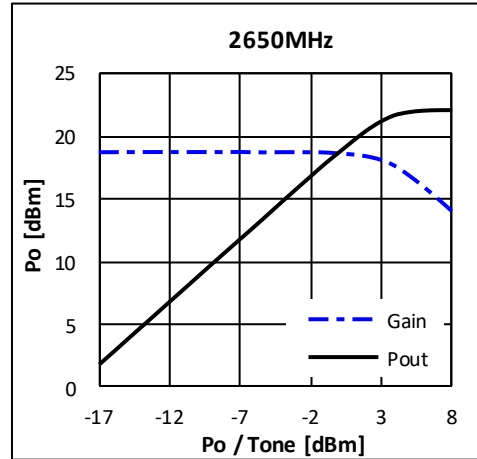
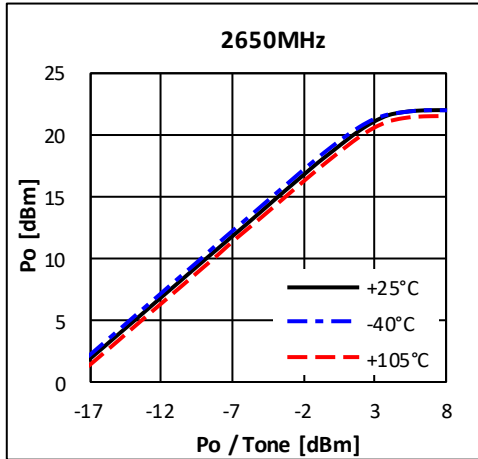

$V_d = 3.3V, I_d = 48mA$

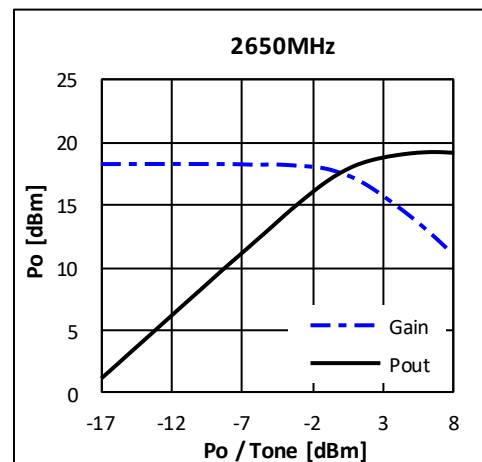
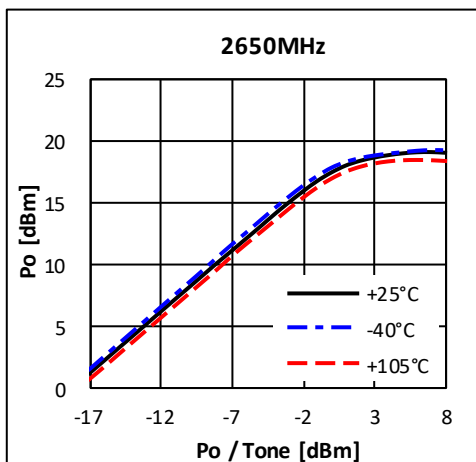
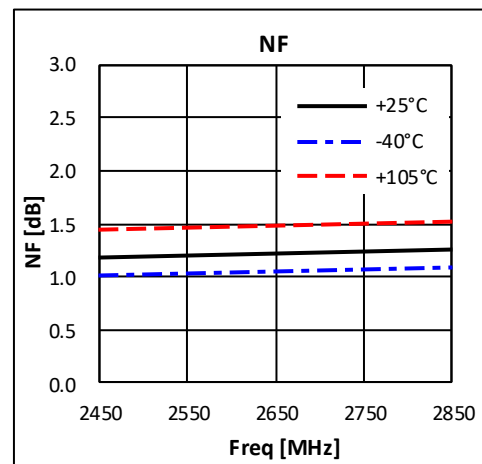
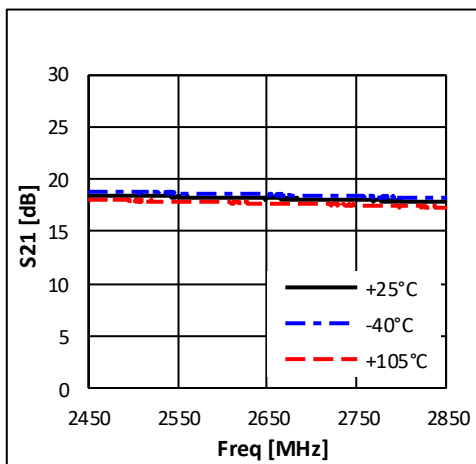
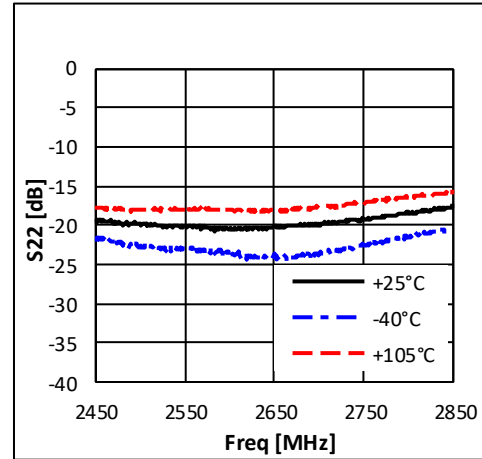
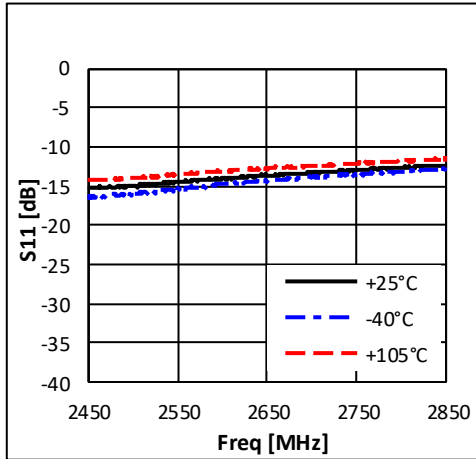

$V_d = 3.3V, I_d = 48mA$

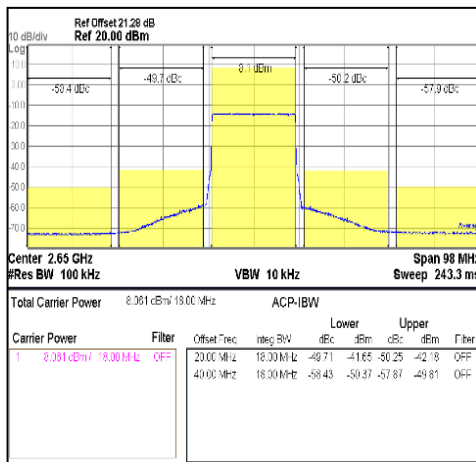
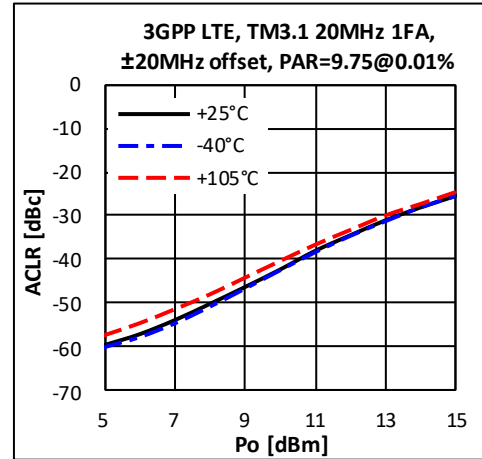
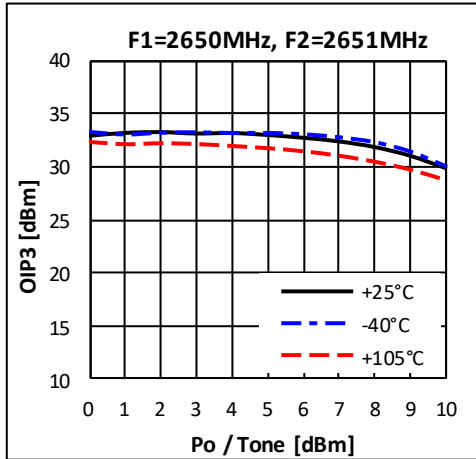

Application Circuit: 3500 MHz

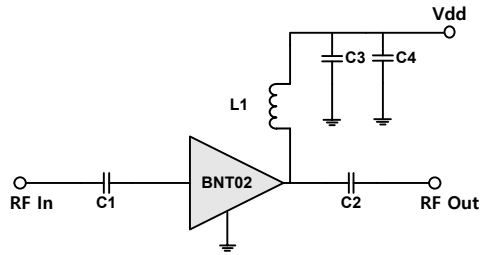
Schematic Diagram		BOM	Tolerance	
		C1	47pF	± 5%
		C2	1pF	± 5%
		C3	100pF	± 5%
		C4	1uF	± 10%
		L1	22nH	± 5%

Typical Performance

$V_d = 5V, I_d = 85mA$

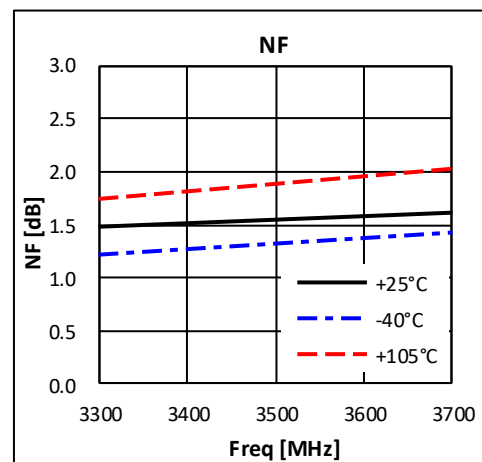
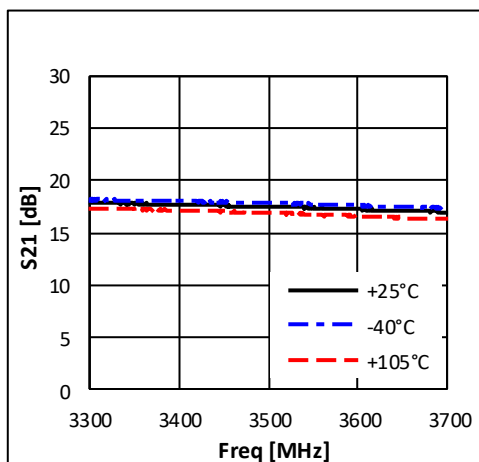
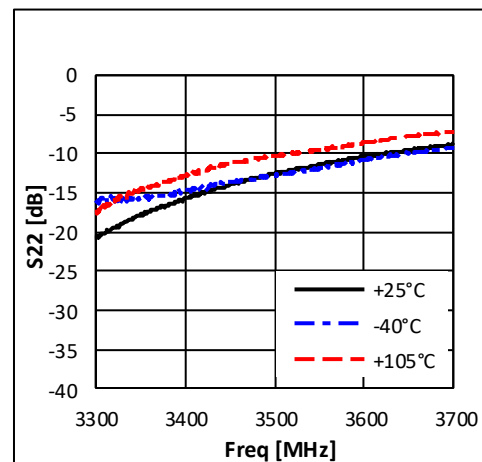
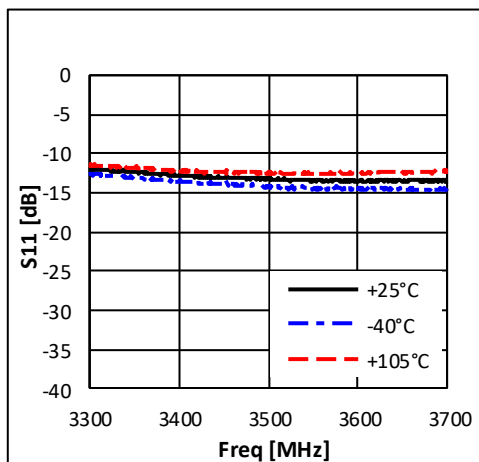

$V_d = 5V, I_d = 85mA$

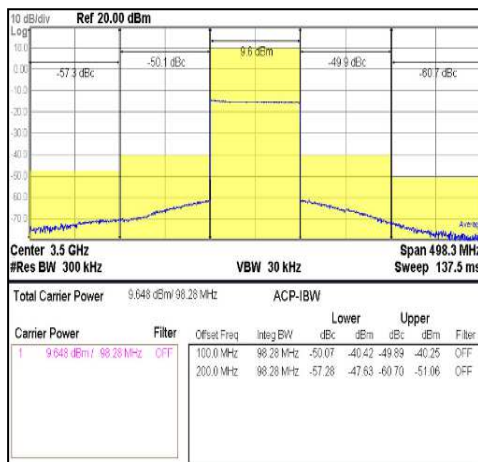
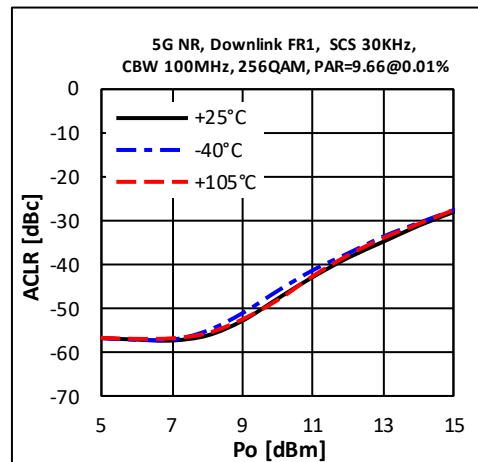
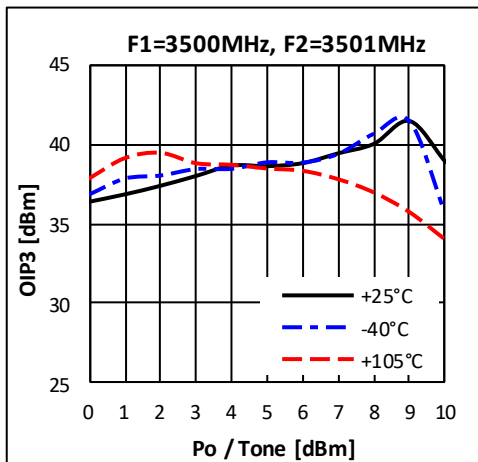
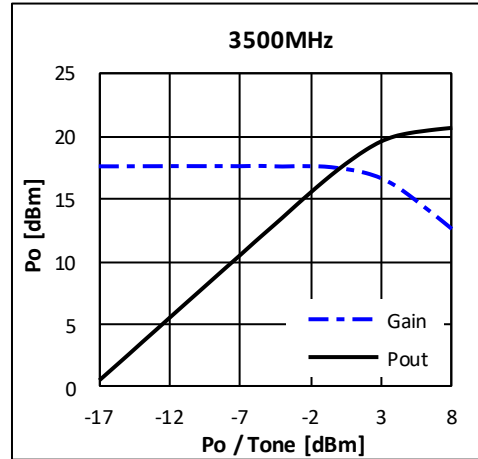
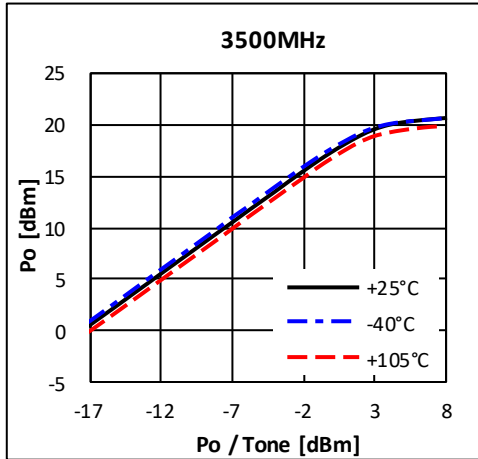

$V_d = 3.3V, I_d = 48mA$

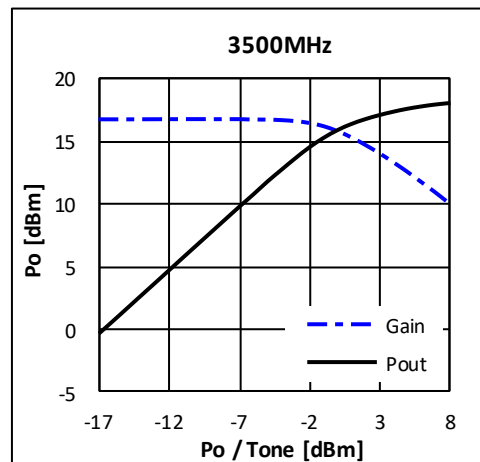
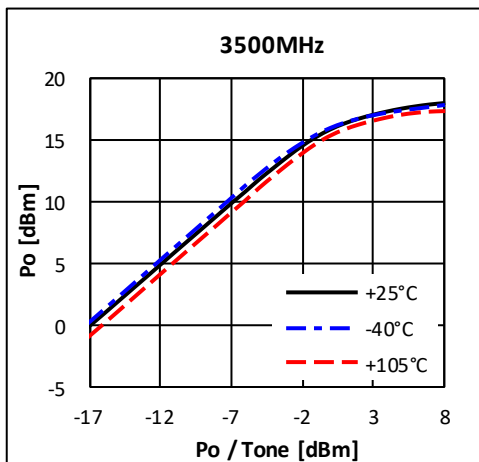
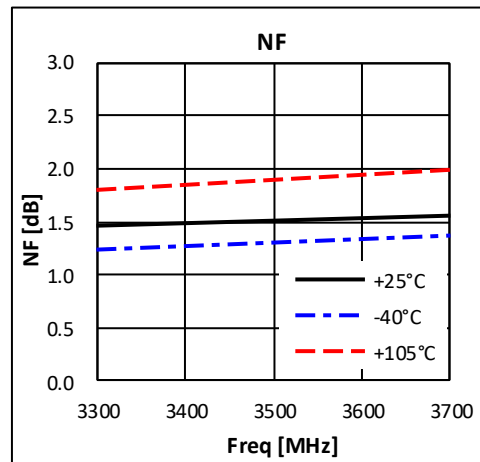
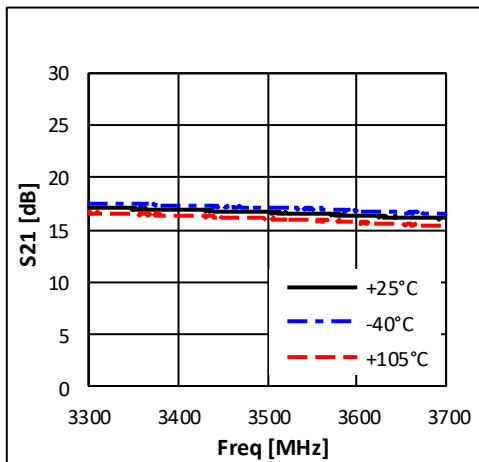
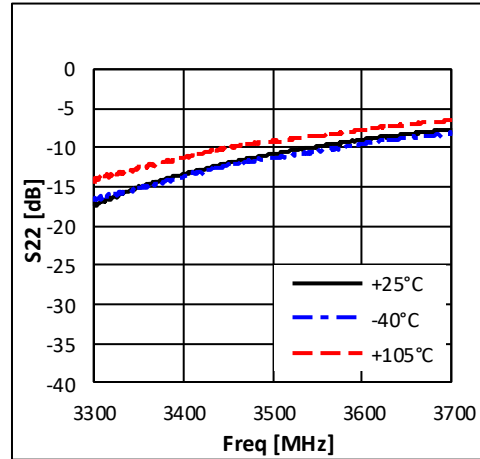
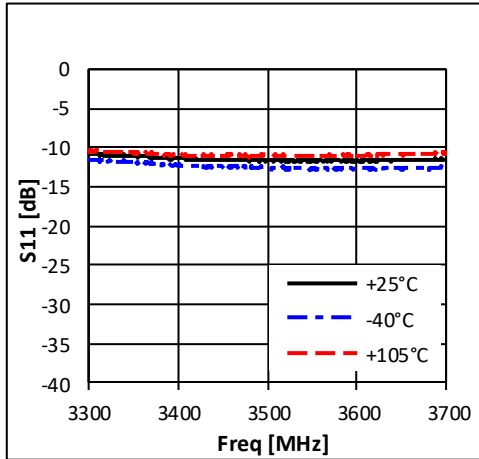

$V_d = 3.3V, I_d = 48mA$

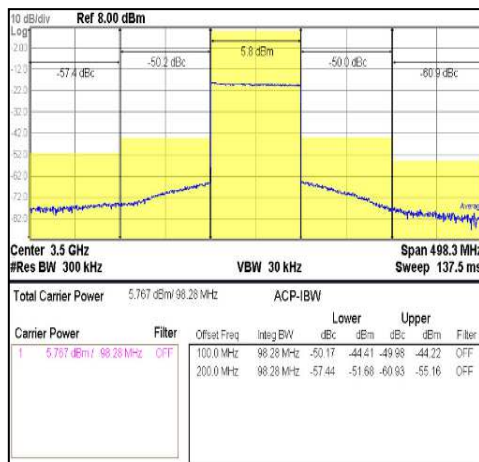
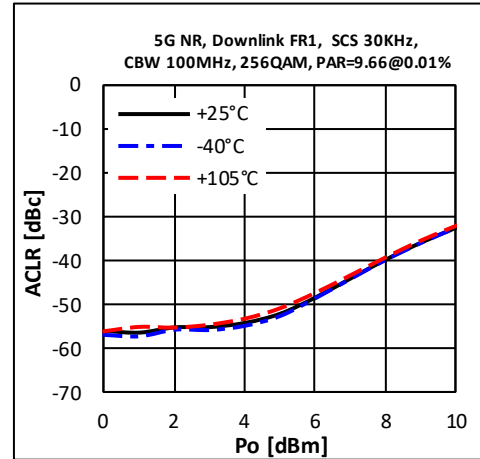
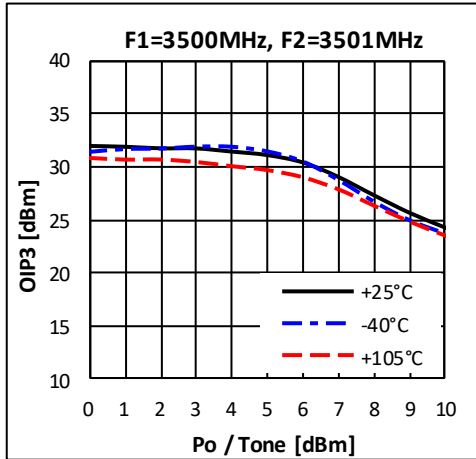

Application Circuit: 4650 MHz

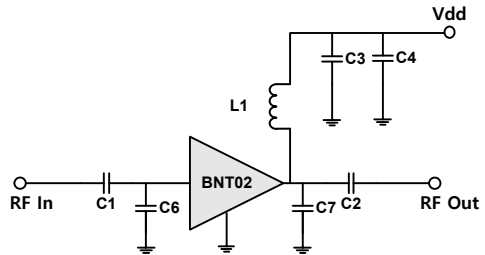
Schematic Diagram		BOM	Tolerance	
		C1	2pF	± 5%
		C2	2pF	± 5%
		C3	100pF	± 5%
		C4	1uF	± 10%
		C6	0.3pF	± 5%
		C7	0.5pF	± 5%
		L1	1nH	± 5%

Typical Performance

$V_d = 5V, I_d = 85mA$

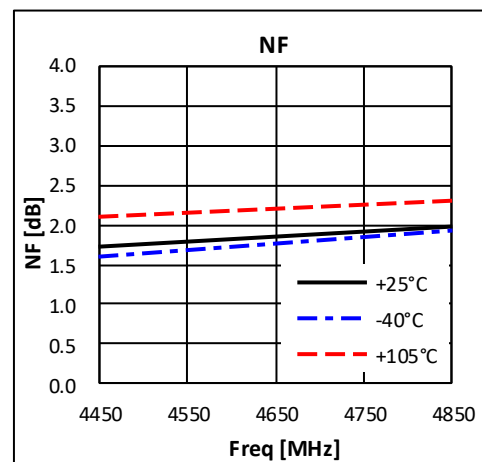
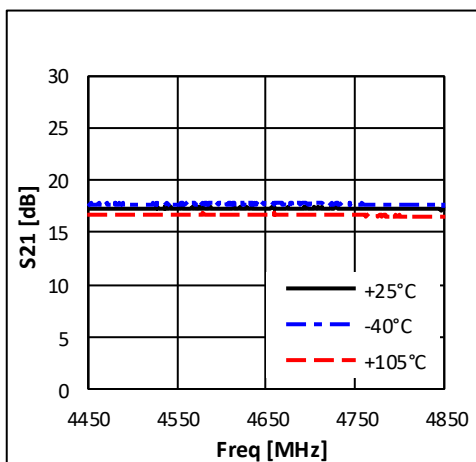
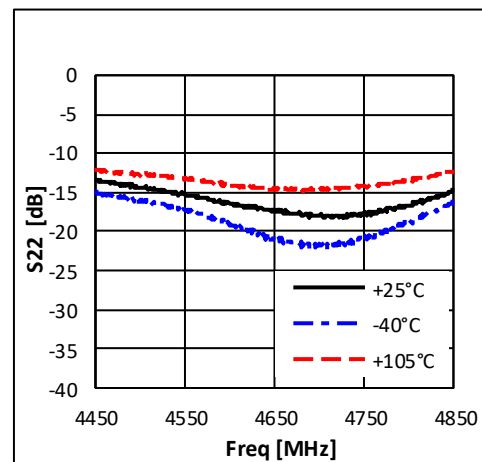
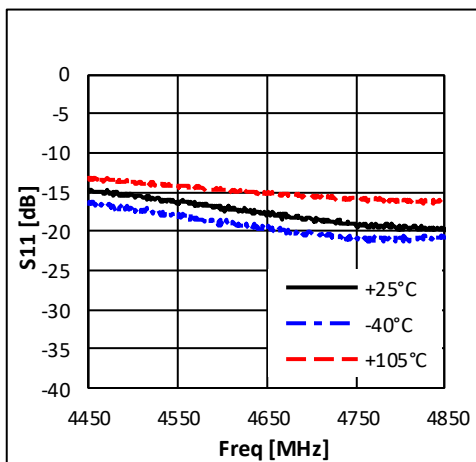

$V_d = 5V, I_d = 85mA$

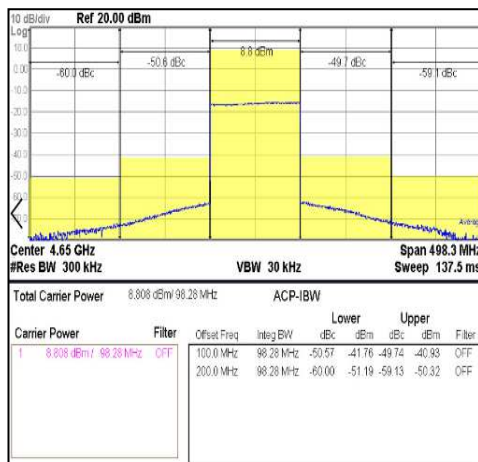
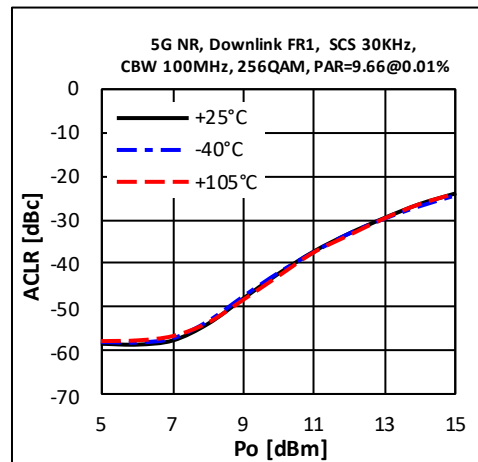
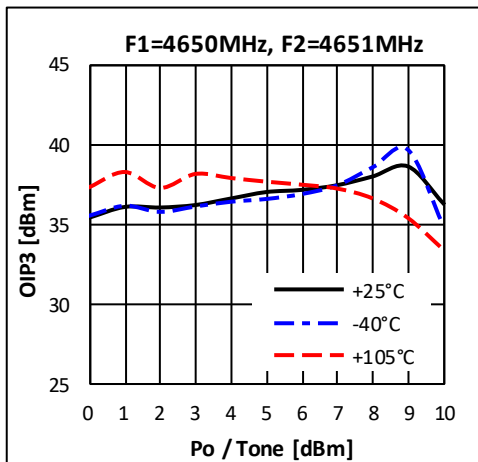
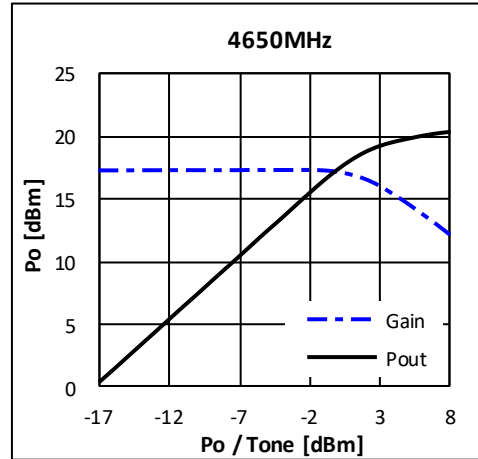
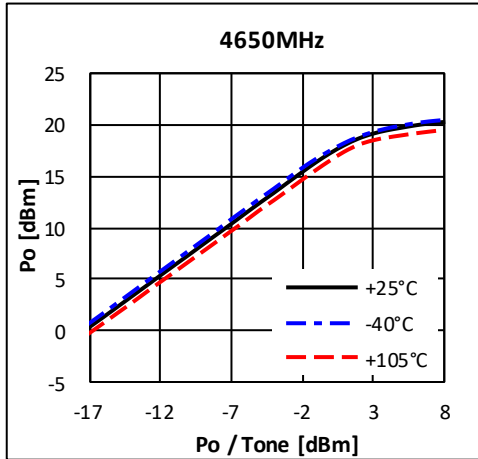

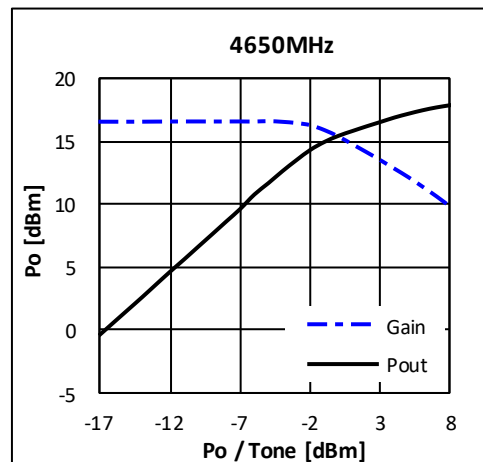
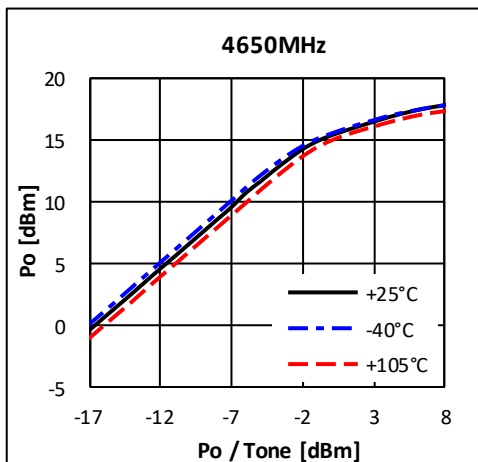
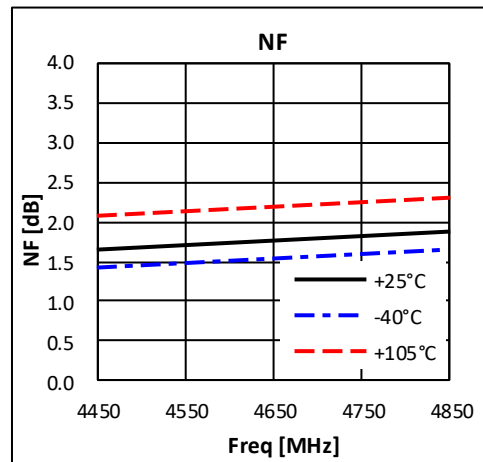
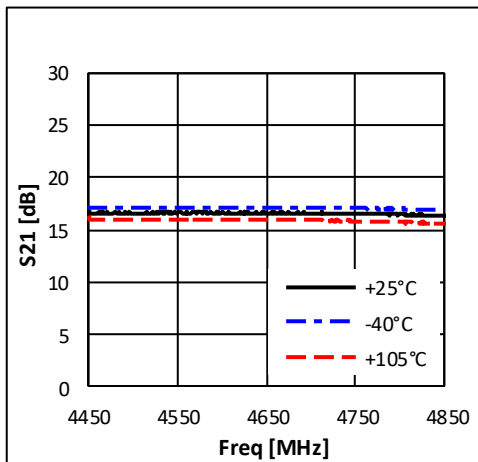
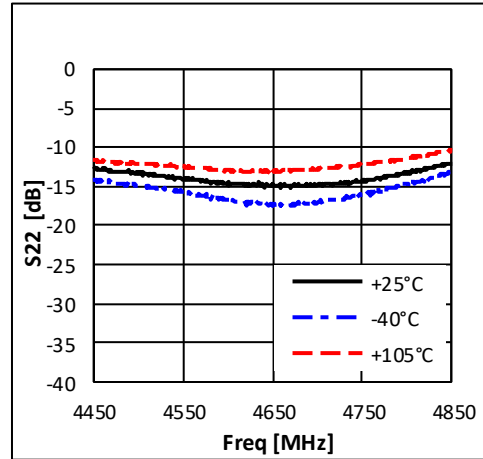
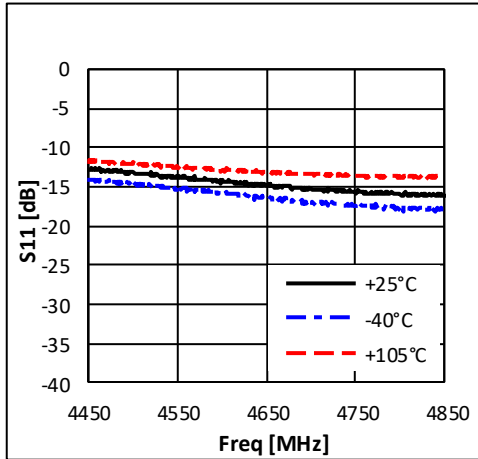
$V_d = 3.3V, I_d = 48mA$

$V_d = 3.3V, I_d = 48mA$

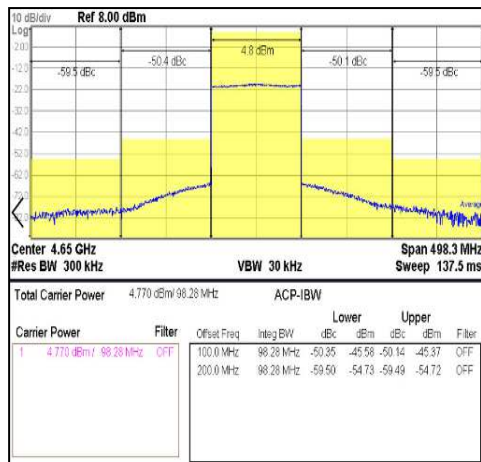
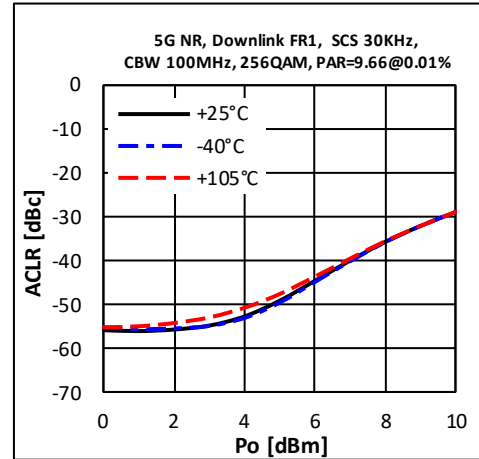
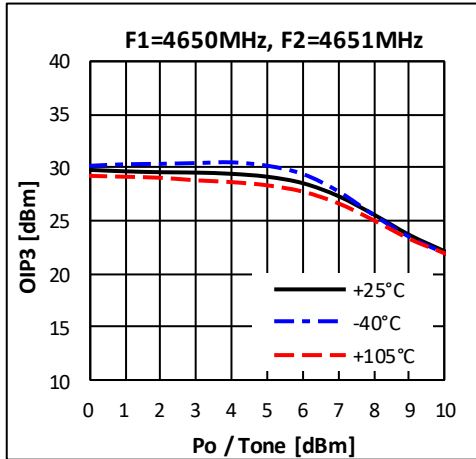

Application Circuit: 5800 MHz

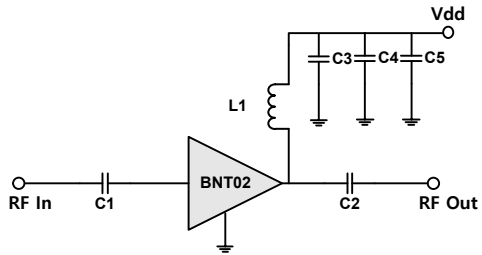
Schematic Diagram		BOM	Tolerance
	C1	1.5pF	± 5%
	C2	1.5pF	± 5%
	C3	100pF	± 5%
	C4	1nF	± 5%
	C5	1uF	± 10%
	L1	1nH	± 5%

Typical Performance

$V_d = 5V, I_d = 85mA$

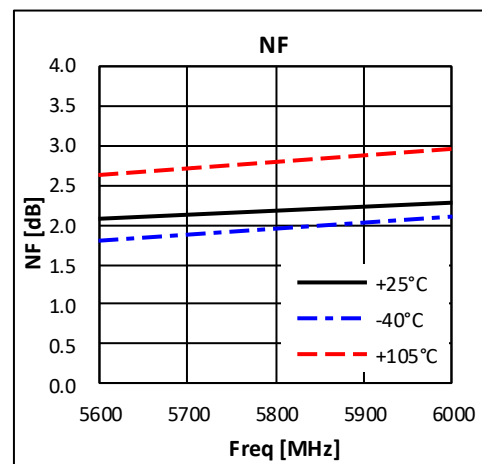
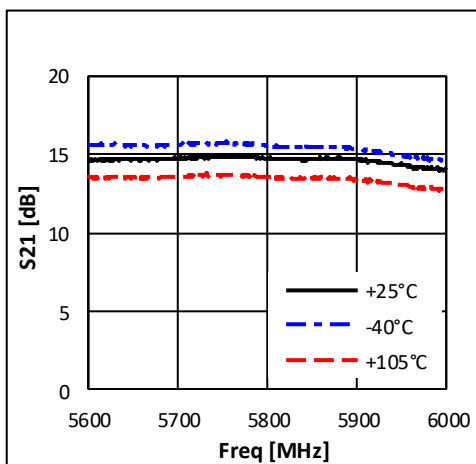
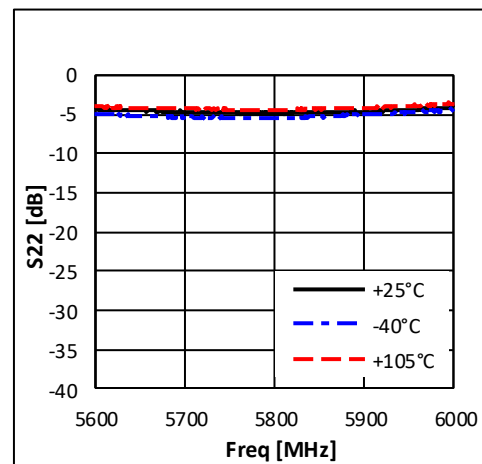
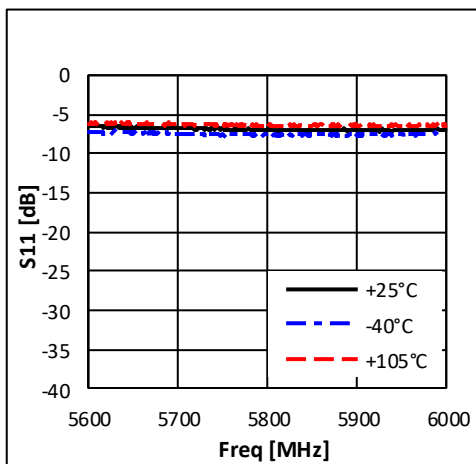

$V_d = 5V, I_d = 85mA$

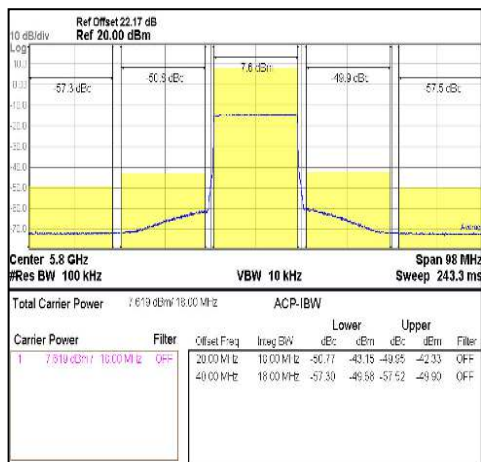
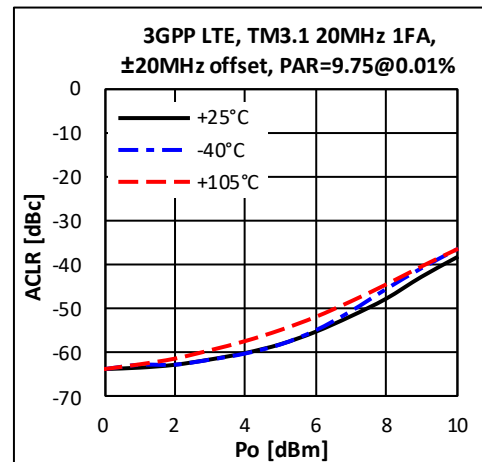
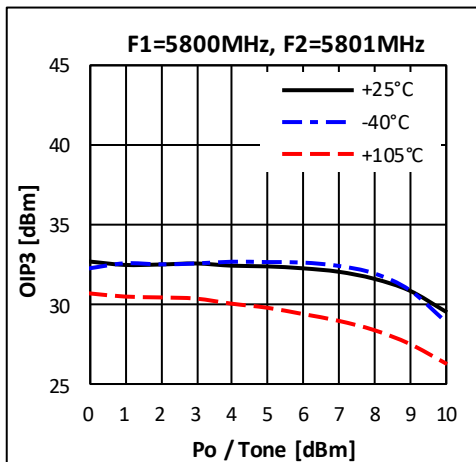
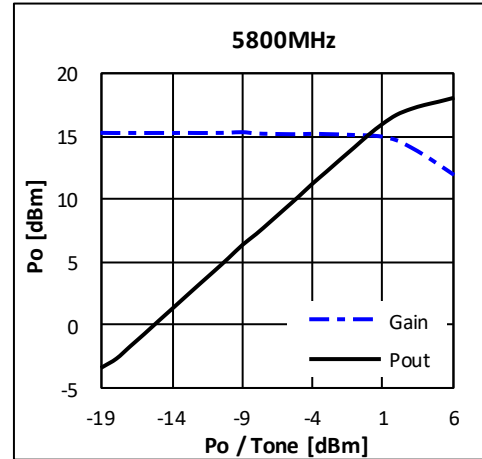
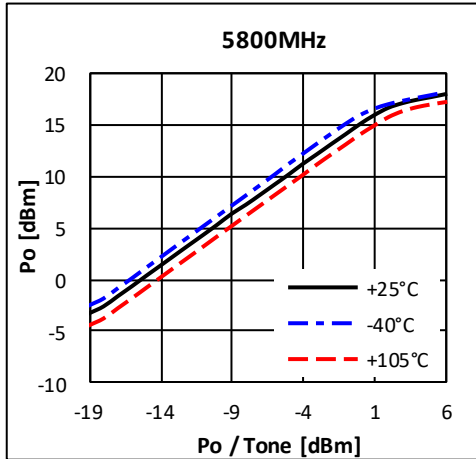

$V_d = 3.3V, I_d = 48mA$

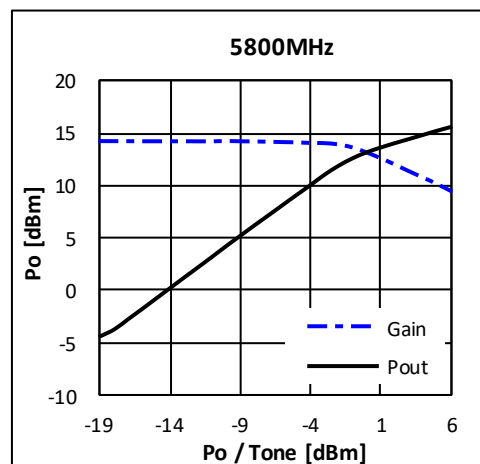
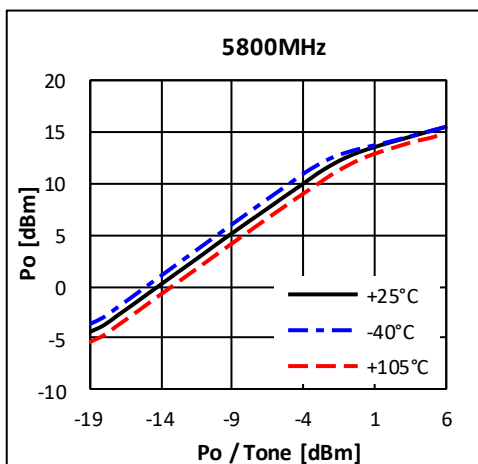
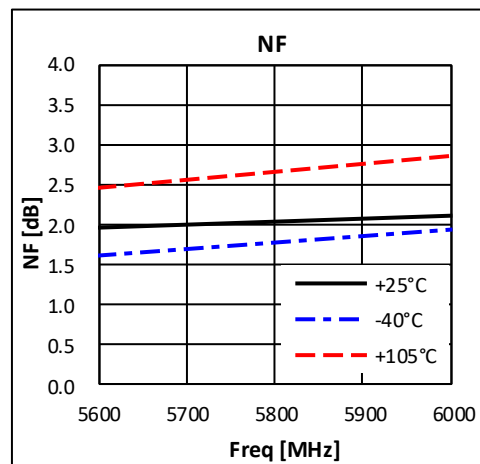
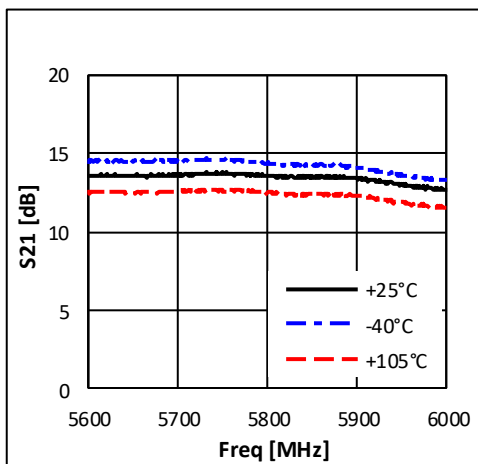
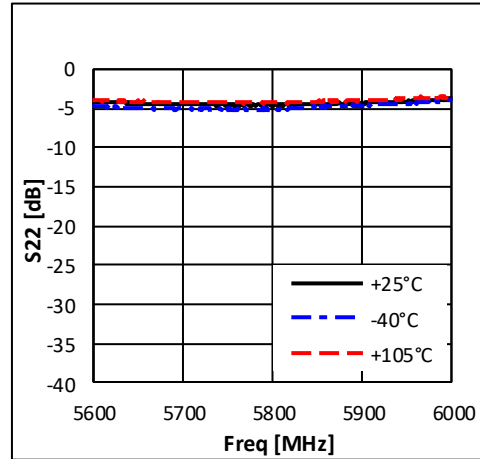
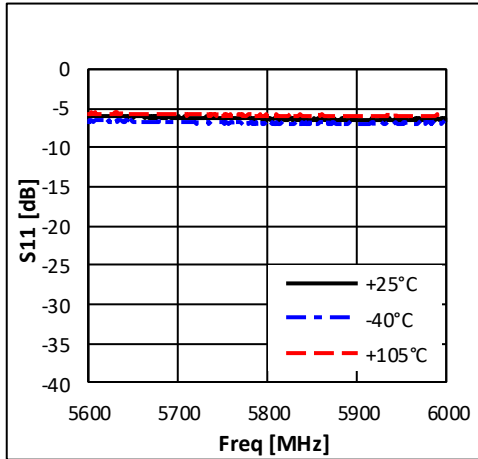

$V_d = 3.3V, I_d = 48mA$

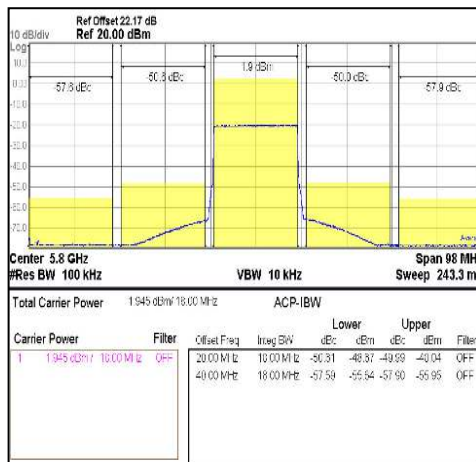
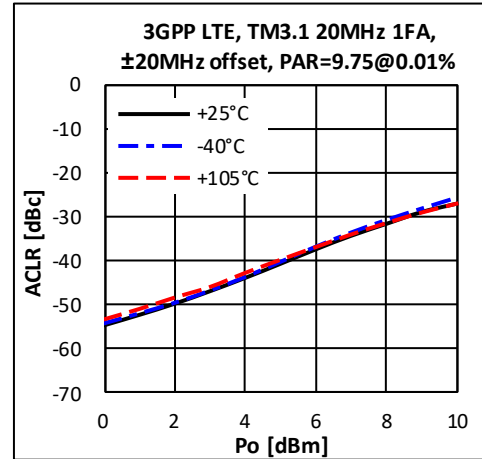
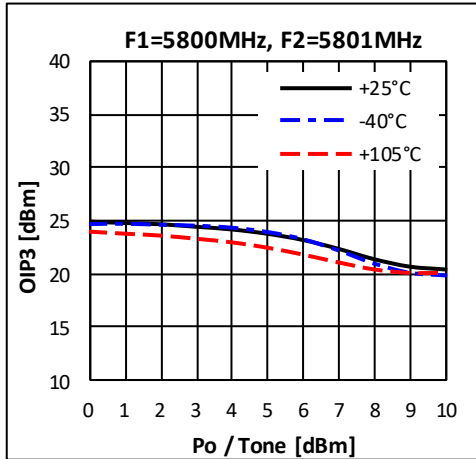

Package Outline Dimension

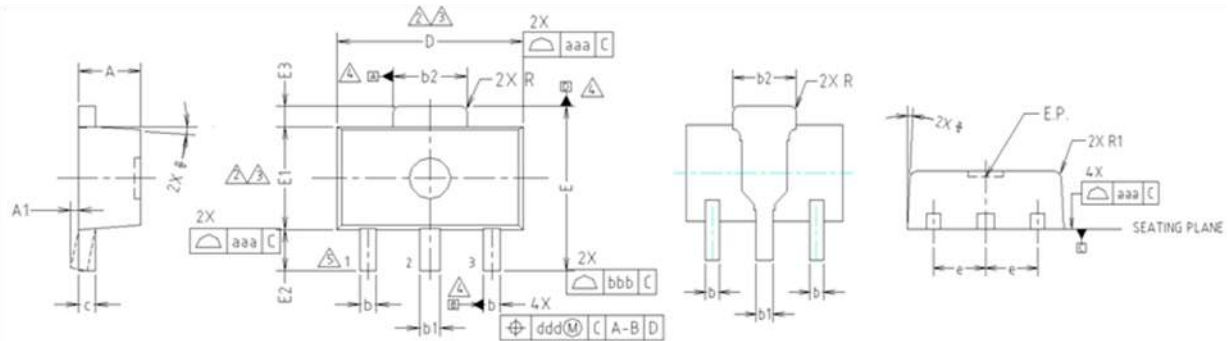

- NOTE:**
 1. DIMENSIONS IN MILLIMETERS.
- ⚠ DIMENSION D DOES NOT INCLUDE MOLD FLASH, PROTRUSIONS OR GATE BURRS. MOLD FLASH, PROTRUSIONS OR GATE BURRS SHALL NOT EXCEED 0.5mm PER END. DIMENSION E1 DOES NOT INCLUDE INTERLEAD FLASH OR PROTRUSION. INTERLEAD FLASH OR PROTRUSION SHALL NOT EXCEED 0.5mm PER SIDE.
 - ⚠ DIMENSIONS D AND E1 ARE DETERMINED AT THE OUTMOST EXTREMES OF THE PLASTIC BODY EXCLUSIVE OF MOLD FLASH, TIE BAR BURRS, GATE BURRS AND INTERLEAD FLASH, BUT INCLUDING ANY MISMATCH BETWEEN THE TOP AND BOTTOM OF THE PLASTIC BODY.
 - ⚠ DATUMS A, B AND D TO BE DETERMINED 0.18mm FROM THE LEAD TIP.
 - ⚠ TERMINAL NUMBERS ARE SHOWN FOR REFERENCE ONLY.

SYMBOL	MILLIMETERS			NOTE
	MINIMUM	NOMINAL	MAXIMUM	
A	1.40	1.50	1.60	
A1	0.00	—	0.10	
b	0.38	0.42	0.48	
b1	0.48	0.52	0.58	
b2	1.79	1.82	1.87	
c	0.40	0.42	0.46	
D	4.40	4.50	4.70	2,3
E	3.70	4.00	4.30	
E1	2.40	2.50	2.70	2,3
E2	0.80	1.00	1.20	
E3	0.40	0.50	0.60	
e	1.50 TYP.			
a	.4° TYP.			
R	0.15 TYP.			
R1	—			0.20
SYMBOL	TOLERANCES OF FORM AND POSITION		NOTE	
aaa	0.15			
bbb	0.20			
ccc	0.10			
ddd	0.10			

PCB Land Pattern

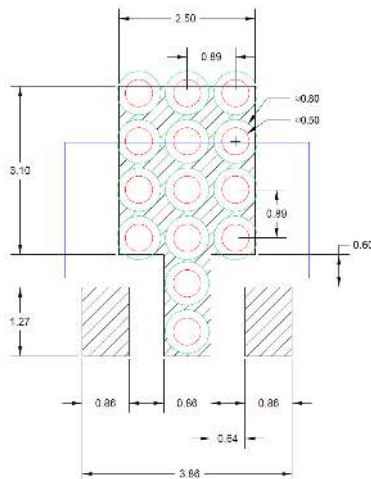

Note : All dimension _ millimeters

PCB lay out _ on BeRex website

PCB Mounting

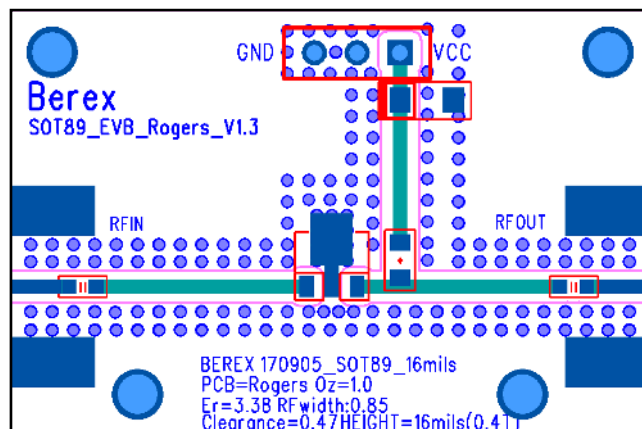

Package Marking

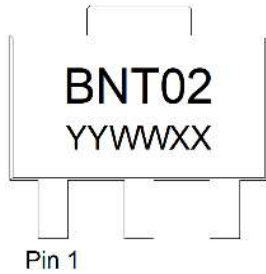

YY = Year, WW = Working Week,
XX = Wafer No.

Tape & Reel

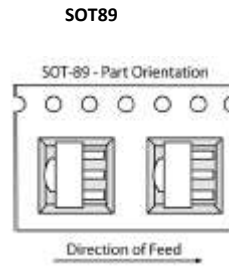

Packaging information:

Tape Width (mm): 12
Reel Size (inches): 7
Device Cavity Pitch (mm): 8
Devices Per Reel: 1000

Lead plating finish

100% Tin Matte finish

(All BeRex products undergoes a 1 hour, 150 degree C, Anneal bake to eliminate thin whisker growth concerns.)

MSL / ESD Rating

ESD Rating:	Class 1C
Value:	Passes <2000V
Test:	Human Body Model (HBM)
Standard:	JEDEC Standard JS-001-2014
MSL Rating:	Level 1 at +260°C convection reflow
Standard:	JEDEC Standard J-STD-020



Proper ESD procedures should be followed when handling this device.

RoHS Compliance

This part is compliant with Restrictions on the Use of Certain Hazardous Substances in Electrical and Electronic Equipment (RoHS) Directive 2011/65/EU as amended by Directive 2015/863/EU.

This product also is compliant with a concentration of the Substances of Very High Concern (SVHC) candidate list which are contained in a quantity of less than 0.1%(w/w) in each components of a product and/or its packaging placed on the European Community market by the BeRex and Suppliers.

NATO CAGE code:

2	N	9	6	F
---	---	---	---	---