

PRODUCT SPECIFICATION

PRODUCT NAME: FAN MOTOR

MODEL: 9GA0412P6G023



SPECIFICATION No.: S5269094

Signature

We would kindly like you to check all specifications, make your signature on one copy, and return it to us by 14-September-2019. When you have corrections, please write them in red. If this is not returned by the due date, we will deliver the products following this product specification.

Caution



- To ensure that this product is used safely, be sure that you read and understand the following precautions fully and use the product only as directed.
- Be sure to read the Safety Precautions carefully before installing, connecting, operating, maintaining, or inspecting this product. Follow all the precautions and directions given here.
- This product has been designed and manufactured for use as a device to be used in general industrial machinery, and may not be used as a standalone product.
- The product of our company (hereinafter called the product) falls into the category of the products specified in the Attached List 1, Item 16 (Class 84, Item 14) of the Export Trade Control Ordinance. To export the product as an individual part or to export a product into which the product is assembled, the "Informing Requirements" and "Objective Requirements" that the Ministry of Economy, Trade and Industry of Japan established based on the "Catch-all Controls" must be studied for applicability. Accordingly, appropriate export formalities must be performed.
- When disposing the product, treat it as industrial waste. Please contact your local government office for further details about disposal.
- To prevent any possible bodily injury or damage to property or equipment, the following precautions for ensuring safety are displayed according to the following two ranks of importance:

 Danger	Handling or using the product improperly and in disregard of the instructions with this mark may result in serious bodily injury or death.
 Caution	Handling or using the product improperly and in disregard of the instructions with this mark may result in bodily injury or physical damage.

Note: Items marked 'Caution' might also result in serious bodily injury or death in some circumstances.

Always follow the instructions the same as for items marked 'Danger.'

SANYO DENKI CO., LTD.

APPROVED BY	CHECKED BY	DESIGNED BY
 August 14, 2019	 August 14, 2019	 August 07, 2019



Safety Precautions (1/2)

Danger

- When using the product in the following environments, use it at your own discretion only after deploying sufficient safety measures and making prior evaluations.
- Equipment such as medical equipment related to human life, facilities that have serious social and public effects, or environments with vibrations such as in-automobiles or ships.
- Ensure that wiring has been correctly done. Failure to do so may result in fire, burns, or electrical shock.
- If there are any grounding taps or wires, ground them securely. There is danger of electrical shock.
- Never use in explosive atmospheres, as doing so might result in fires, burns, or bodily injury.
- Do not operate the product when electronic components are exposed. There is danger of electric shock.
- Never allow any persons or objects to approach or come into contact with the rotor while in operation, as doing so might result in damage or personal injury.
- Turn off the power and stop using the product immediately if you notice any sparks, smoke, odd odors, sounds, or anything unusual during operation. There is danger of electrical shock, fires, or bodily injury.
- Never allow the product to fall, topple over, or otherwise be subjected to excessive shocks when moving it, as doing so might result in product breakdown or substandard operation.
- The product should be handled only by personnel with sufficient training and knowledge and under the responsibility of the end user.
- Never attempt to disassemble, repair, or alter this product in any way, as doing so might result in electrical shock, fires, or bodily injury.

Caution

Handling

- Installation, placement, connections, wiring, or relocation of the product should be performed by knowledgeable or correctly licensed personnel. Never perform such work while the product is on, as this might lead to injury, electrical shock, burns, or fire.
- Do not use the fan if it is not fixed, nor while held in hand.
- Never allow yourself to come into contact with the ends of wires or plugs when measuring insulation resistance or dielectric strength voltage. There is danger of electrical shock.
- Never attempt to disassemble or alter this product in any way. Doing so may invalidate any warranties concerning the functions or performance of the product, and may also result in fire, burns, bodily injury, or electrical shock.

Cautions for operation

- Give proper consideration to the device for its protection in case the fan stops during operation.
- Never use the product at voltages, temperatures, or any other settings which exceed those given in the product specifications. This might result in substandard operation, breakdown, fire, bodily injury, or electrical shock.
- The fan may fail to operate properly if there is insufficient power capacity, because a starting current several times larger than the rated current will flow at the moment voltage is supplied to the fan. Be sure to inquire about starting current levels for individual models.
- Do not control the speed of the fan by changing power voltage using PWM. It may cause fan failure.
- Start all fans at the same time when two or more fans whose wind creates interference are installed in the device. If the fan is exposed to wind from other fans at startup, it may cause fan failure or the fan may not start up correctly.
- Never insert or remove any lead wires, plug cords, or connectors while the power is turned on. When inserting or removing plugs or connectors, always be sure to first check that the power has been turned off, and hold the fan frame of the plug or connector when doing so. Failure to do so might result in damage or electrical shock.
- Do not remove the lead wire of the fan from the frame hook. Doing so may scratch and damage the surface of the lead wire.
- Do not remove the nameplate. There is danger of electrical shock or failure.
- Do not push the nameplate of the fan with strong force. The nameplate may break or come in contact with the shaft.
- The product might become damaged if foreign objects or external forces interfere with normal fan operation.
- Do not implement ON-OFF on the negative power supply line. That might damage the fan.

Safety Precautions (2/2)

Caution

Installation

- When fixing this product into place, be sure to take the product's weight, vibrations generated during operation, and all other relevant factors into consideration. Failure to do so may result in the product or its parts falling, resulting in bodily injury or device failure.
- Be sure to check the installation direction (i.e., the fan), as failing to do so might result in bodily injury or mechanical breakdown.
- To ensure that the product operates properly, allow spaces for ventilation and take necessary steps to prevent the entry of foreign objects. Failure to do so might result in bodily injury or mechanical breakdown.
- When fixing the fan with screws, ensure the screwing torque. If the screwing torque exceeds the recommended torque, the fan frame may be deformed or damaged. Use a ribbed frame when using through-screws to affix fans with plastic frames. To prevent loose screws, use plain washers or spring lock washers. For the screwing torque of each fan type, contact SANYO DENKI or a SANYO DENKI distributor.
- When fixing the fan with self-tapping screws, the fan frame may be damaged.
- When excessive shock is applied to the fan, the impeller may protrude from the surface of the fan frame. Make sure that the impeller does not touch covers, such as finger guards or mounting plates.
- Do not subject fans to excessive shock to avoid fan failure and performance deterioration.
- Pulling or pinching lead wires could result in damage to the wire; avoid placing excessive stress on wires. The device should be installed so that the lead wires do not come into contact with the rotor or blades. Failure to do so might result in damage or electrical shock.
- Take proper precautions against static electricity when making electrical connections. Failure to do so might cause the breakdown of the fan or device.
- Install a finger guard or other cover if there is any danger of fingers, hands, or objects coming into contact with the rotor or blades. Failure to do so might result in bodily injury or mechanical breakdown.
- Install finger guards, filters, and plates in the correct position while avoiding touching the rotor blade. Avoiding this will prevent device failure. Please use only genuine SANYO DENKI finger guards and filter kits.
- Make electrical connections properly. If not there is a possibility that the device might break, or that the product might malfunction, breakdown, or have degraded performance.

Operating environment

- Avoid using or storing the product in the following areas and environments. There is the possibility that a fire may occur, the product may malfunction, or its performance may deteriorate.
- Flammable or corrosive gas atmospheres, in places where water or oil splashes (not applicable to Splash Proof or Oil Proof Fans), in places where there is much dust or humidity, in places where condensation occurs, in places where the product is exposed to radioactive rays or is in direct sunlight, in places where a salty sea breeze blows or seawater splashes, or in an environment where the product may be contaminated by such corrosive materials as sulfurous water, sulfurous volcanic ash, organic solvents, acidic chemicals, alkali chemicals, etc., or such hazardous substances as nuclear fuel materials, etc.
- Avoid using or storing the product in the following areas and environments. Doing so might result in product breakdown or substandard operation.
- Environments where it could be constantly exposed to vibrations, strong shocks, centrifugal force, acceleration (excluding G Proof Fans) magnetic or electromagnetic noise, areas in which the electromagnetic noise overlaps into power voltage, or areas subjected to rapid environmental fluctuations (temperature, humidity, etc.)

Maintenance

- Maintenance and inspections should always be performed by personnel with sufficient training and knowledge. Otherwise, it may result in fire, burns, bodily injury, or electrical shock.
- Never perform any maintenance or inspections while the product is in operation. Also note that the blades continue to rotate for some time immediately after operation ceases. Always confirm that all rotating parts have come to a stop before beginning work. There is danger of electrical shock, fires, or bodily injury.
- Never use gasoline, paint thinner, benzene, or other organic solvents to clean the product, as this could result in deformation or substandard operation.

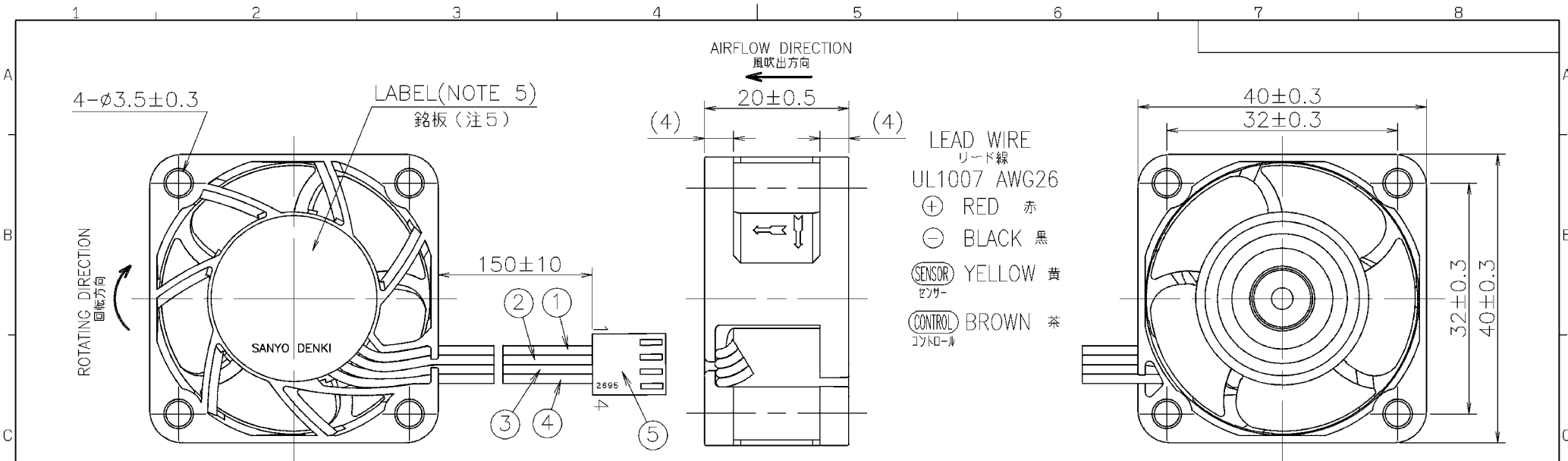

LEAD WIRE
リード線
UL1007 AWG26

- ⊕ RED 赤
- ⊖ BLACK 黒
- SENSOR YELLOW 黄
- CONTROL BROWN 茶

PWM DUTY CYCLE PWMデューティサイクル	100%	0%
RATED VOLTAGE 定格電圧	12 V DC	
OPERATING VOLTAGE 使用電圧範囲	10.2 V DC ~ 13.8 V DC	
RATED CURRENT 定格電流	0.23 A AT 12 V DC (DC12 Vにて)	0.04 A AT 12 V DC (DC12 Vにて)
RATED SPEED 定格回転速度	16000 ± 2000 min ⁻¹ AT 12 V DC (DC12 Vにて)	3800 ± 1140 min ⁻¹ AT 12 V DC (DC12 Vにて)
INSULATION RESISTANCE 絶縁抵抗	10 MΩ MIN. AT 500 V DC (NOTE2) DC500 Vメーターにて10 MΩ以上(注2)	
DIELECTRIC STRENGTH 絶縁耐圧	1 MINUTE AT 500 V AC, 50/60 Hz (NOTE2) AC50/60 Hz, 500 Vにて1分間耐えること(注2)	
OPERATING TEMPERATURE 使用温度範囲	-20 °C ~ +70 °C	
SOUND PRESSURE LEVEL 音圧レベル	47 dB(A) (NOMINAL) (NOTE1) (中心値) (注1)	14 dB(A) (NOMINAL) (NOTE1) (中心値) (注1)
MASS 質量	APPROX. 35 g 約	
MATERIAL 材質	FRAME, IMPELLER : PLASTICS フレーム・羽根 : 樹脂成形品	
BEARING SYSTEM 軸受	2 BALL BEARINGS ボールベアリング	
CONTROL TERMINAL コントロール端子	SOURCE CURRENT : 1 mA MAX AT CONTROL VOLTAGE 0 V. ソース電流 : 以下(コントロール電圧 0 V時)	
	SINK CURRENT : 1 mA MAX AT CONTROL VOLTAGE 5.25 V. シンク電流 : 以下(コントロール電圧 5.25 V時)	
	CONTROL TERMINAL VOLTAGE : 5.25V MAX (OPEN CIRCUIT) 端子電圧 : 以下(コントロール端子オープン時)	

5 CONTACT コネクタ	MOLEX 08-55-0101 モレックス
CONNECTOR コネクタ	MOLEX 22-01-3047 P/N2695-04RP モレックス
4 LEAD WIRE リード線	UL1007 AWG26 BROWN PIN No.4 茶
3 LEAD WIRE リード線	UL1007 AWG26 YELLOW PIN No.3 黄
2 LEAD WIRE リード線	UL1007 AWG26 RED PIN No.2 赤
1 LEAD WIRE リード線	UL1007 AWG26 BLACK PIN No.1 黒
No. PARTS 種別名称	REMARKS 備考

- MOTOR IS PROTECTED FROM DAMAGE OF LOCKED ROTOR CONDITION AT THE OPERATING VOLTAGE.
ファン拘束時焼損の恐れはない。
- FOR SENSOR SPEC., SEE 9D0001H111.
THE SWITCHING BY PWM CONTROL MAY INFLUENCE THE SENSOR OUTPUT.
センサー仕様は、9D0001H111による。
PWM制御によるスイッチングがセンサ出力に影響する場合があります。
- PRINT PRODUCT NAME, MODEL No., MANUFACTURER, AND MANUFACTURED DATE ETC.
品名, 型名, 製造会社名 及び 製造年月日等を表示する。
- ALL VALUES OF EACH CHARACTERISTICS ARE AT ROOM TEMPERATURE AND NORMAL HUMIDITY.
諸特性は常温、常湿での値です。

PERFORMANCE CURVES

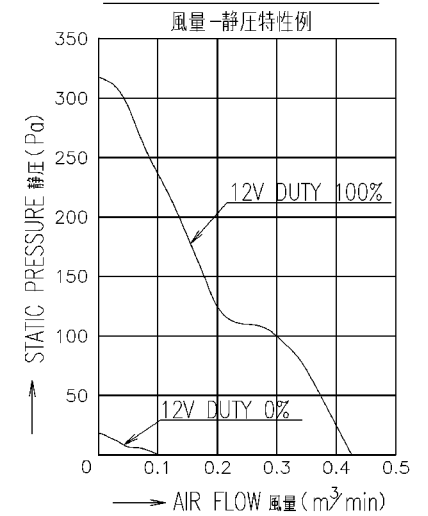

NOTE: 1. MEASURED AT 1 m DISTANCE FROM THE AIR INLET.
注 ファン吸込側より1 mにて測定する。
2. MEASURED BETWEEN THE LEAD WIRES AND THE FRAME.
リード線導体部とフレームとの間。

承認 APPROVED BY TE.YAMAZAKI 19-08-14		12 V PWM SIGNAL VARIABLE SPEED PWM信号 可変速ファン	
審査 CHECKED BY TE.YAMAZAKI 19-08-14		名称 TITLE San Ace 40 (9GA) RIBBED	
設計 DESIGNED BY N.QUIROZ 19-08-07		サンエース40 9GAタイプ リブ付	
図番 DWG NO. 9GA0412P6G023		REV. A/2	
D12,E0		01035273,0001	

山洋電気株式会社
SANYO DENKI CO., LTD.
2019-08-17
ISSUED

A3G-F-1

PWM DUTY CYCLE (BETWEEN CONTROL LEAD AND ⊖LEAD) - SPEED CHARACTERISTIC (REFERENCE)
 PWMデューティサイクル (コントロール-⊖) - 回転速度特性例

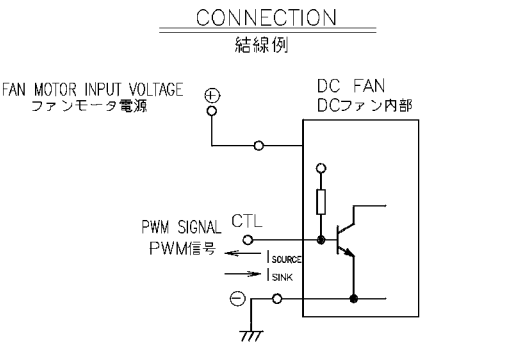
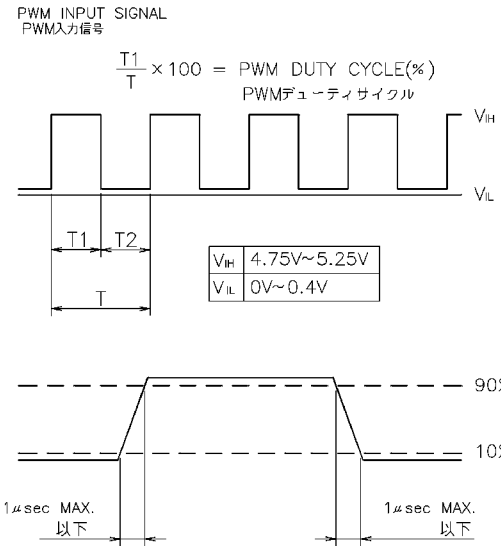
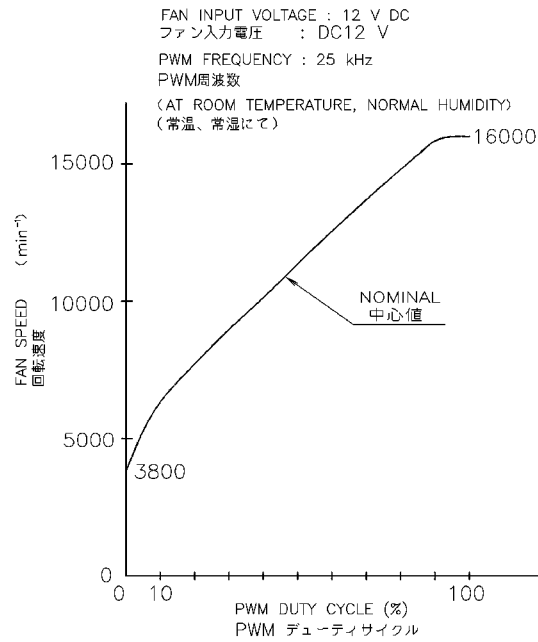

NOTE:
 注

- WHEN PWM DUTY CYCLE IS 100%, REFER TO PAGE 1 FOR THE SPEED.
 PWMデューティサイクルが 100%の時、回転速度は1頁を参照のこと。
- WHEN PWM DUTY CYCLE IS 0%, REFER TO PAGE 1 FOR THE SPEED.
 PWMデューティサイクルが 0%の時、回転速度は1頁を参照のこと。
- WHEN THE CONTROL LEAD WIRE IS NOT CONNECTED.
 THE SPEED IS THE SAME SPEED AS AT 100% OF PWM DUTY CYCLE.
 PWM入力端子がオープン状態の時、回転速度はPWMデューティサイクル100%と同じであること。
- INPUT PWM FREQUENCY IS 25 kHz.
 入力PWM周波数は、25 kHzであること。
- THIS FAN SPEED SHOULD BE CONTROLLED BY PWM INPUT SIGNAL OF EITHER TTL INPUT OR OPEN COLLECTOR, DRAIN INPUT.
 AND IN CASE OF OPEN COLLECTOR, DRAIN INPUT, THE PWM DUTY CYCLE SHOULD BE $\frac{T-T2}{T} \times 100$.
 PWM入力信号はTTL入力又は、オープンコレクタ、ドレイン入力にて使用可能であること。
 但し、オープンコレクタ、ドレイン入力の場合、
 $\text{PWMデューティ} [\%] = \frac{T-T2}{T} \times 100$ のこと。

			承認 APPROVED BY TE.YAMAZAKI 19-08-14	12 V PWM SIGNAL VARIABLE SPEED PWM信号 可変速ファン
		単位 UNIT mm	審査 CHECKED BY TE.YAMAZAKI 19-08-14	名称 TITLE San Ace 40 (9GA) RIBBED
A	新規作成 N.QUIROZ	19-08-07	設計 DESIGNED BY N.QUIROZ 19-08-07	サンエース40 9GAタイプ リブ付
記号 REV.	記事 DESCRIPTION	日付 DATE	図番 DWG NO. 9GA0412P6G023	REV. A/2/2
山洋電気株式会社 SANYO DENKI CO.,LTD.			SANYO DENKI CO.,LTD. 2019-08-17 ISSUED	
			D12,E0	01035273,0002

SENSOR SPECIFICATION FOR BRUSHLESS DC FAN

ブラシレスDCファン センサー仕様

1. OUTPUT CIRCUIT - OPEN COLLECTOR
出力回路-オープンコレクタ

2. SPECIFICATION
仕様

$$V_{CE} = +13.8 \text{ V DC MAX.}$$

$$I_c = 5 \text{ mA MAX. (} V_{CE(SAT)} = 0.6 \text{ V MAX.)}$$

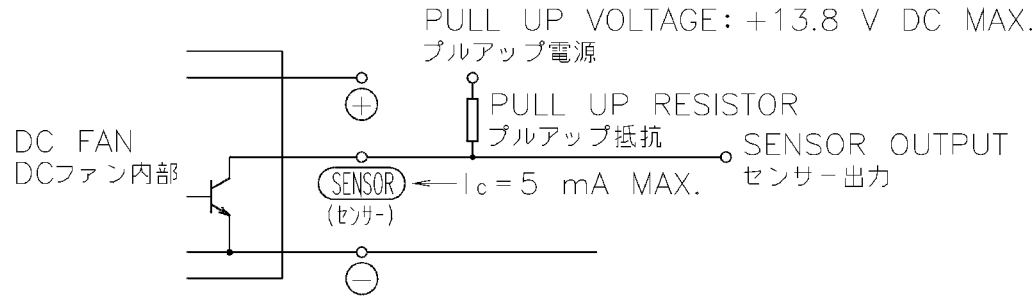

3. WAVEFORM OF SENSOR OUTPUT
センサー出力波形

(a) RUNNING CONDITION
通常回転時

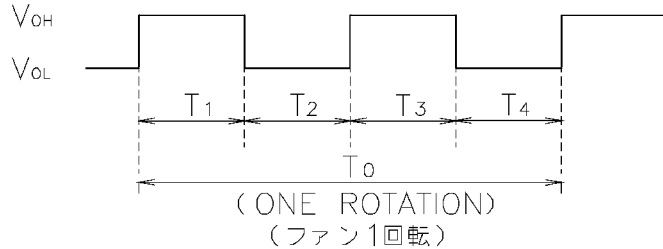

$$T_{1\sim4} \approx (1/4) T_0$$

$$T_{1\sim4} \approx (1/4) T_0 = 60/4 \text{ N (s)}$$

N = FAN ROTATION SPEED (min⁻¹)
ファン回転速度

(b) LOCKED ROTOR CONDITION
羽根ロック時

SENSOR OUTPUT IS FIXED EITHER
(b-1) OR (b-2) AT LOCKED ROTOR CONDITION.
下図のどちらかに固定される。

(b-1) V_{OH} _____
0V _____

(b-2) V_{OH} _____
 V_{OL} _____
0V _____

				承認 APPROVED BY <i>M. Murata</i> 06-10-12	PULSE SENSOR パルスセンサー
			単位 UNIT	審査 CHECKED BY <i>M. Murata</i> 06-10-12	名称 TITLE
B	E0080323	06-10-12	mm	設計 DESIGNED BY J. QUIJAMBAO 06-10-12	SENSOR SPECIFICATION BLDCファン センサー仕様
A	新規作成 御供	03-04-24	尺度 SCALE	図番 DWG NO.	
記号 REV.	記事 DESCRIPTION	日付 DATE			
山洋電気株式会社 SANYO DENKI CO., LTD.			SANYO DENKI CO., LTD. 2019-08-17 ISSUED	9D0001H1111B	REV.
			A3G-F41	7	00514588