

SPECIFICATION

Part Number: **RI.02.01.3000W**

Product Name: 915MHz Road Marker Kit-Quad Band Cellular Antenna RI.01 with CAB.826 Cable Assembly

Features: Low Profile - Diameter 101.4mm*Height 17.6 mm
UV and Vandal resistant PP housing
RI.01: 1.5M WY-100 cable SMB(M) Jack
CAB.826: 1.5M WY-100 SMB(F) to SMA(M)ST

RoHS Compliant

Top



Bottom



Side Profile



1. Introduction

Taoglas USA has designed a range of efficient antennas inside US standard raised non reflective roadmarkers. These are designed for, and installed inside, the low profile “Bott’s dots” that can to be mounted directly on the pavement and road in the USA.

These antennas exhibit remarkably high efficiencies in such small packages and live in a very low profile enclosure. They are designed to be mounted directly on the road or pavement, just like a standard roadmarker.

These antennas have been potted with the epoxy that is traditionally used to secure the roadmarker itself to the ground. There are no air gaps whatsoever inside the new type approved roadmarker with antenna, in order to maintain the mechanical integrity. It is presumed that the standard black epoxy will also be used to install the roadmarker in its final resting place on the ground.

The CAB.826 cable assembly is included so the antenna cable can be easily disconnected if desired. This is useful if the antenna is mounted on a movable area, as the cable will split at the push-pull connectors, preventing damage to the cable.

2. Specification

ELECTRICAL	
Band	915 MHz ISM
Frequency (MHz)	902-928
Polarization	Linear
Impedance (Ohms)	50 Ohms
Peak Gain (dBi)	6.2
Efficiency (%)	26
Return Loss (dB)	-18
Radiation Properties	Omni-directional
Max Input Power (Watts)	10
MECHANICAL	
Dimensions	Height = 17.6 mm and Diameter =101.4mm
Cable	WY100 Coaxial cable
Connector	SMB (M) Jack Straight 50 Ohms
Casing	UV Resistant PP
Sealant	Potting
ENVIRONMENTAL	
Protection	IP67
Corrosion	5% NaCl for 96hrs
Temperature Range	-40°C to +85°C
Thermal Shock	100 cycles -40°C to +85°C
Humidity	Non-condensing 65°C 95% RH
Shock (Drop Test)	1m drop on concrete 6 axes
Cable Pull	8 Kgf

3. Test Set Up

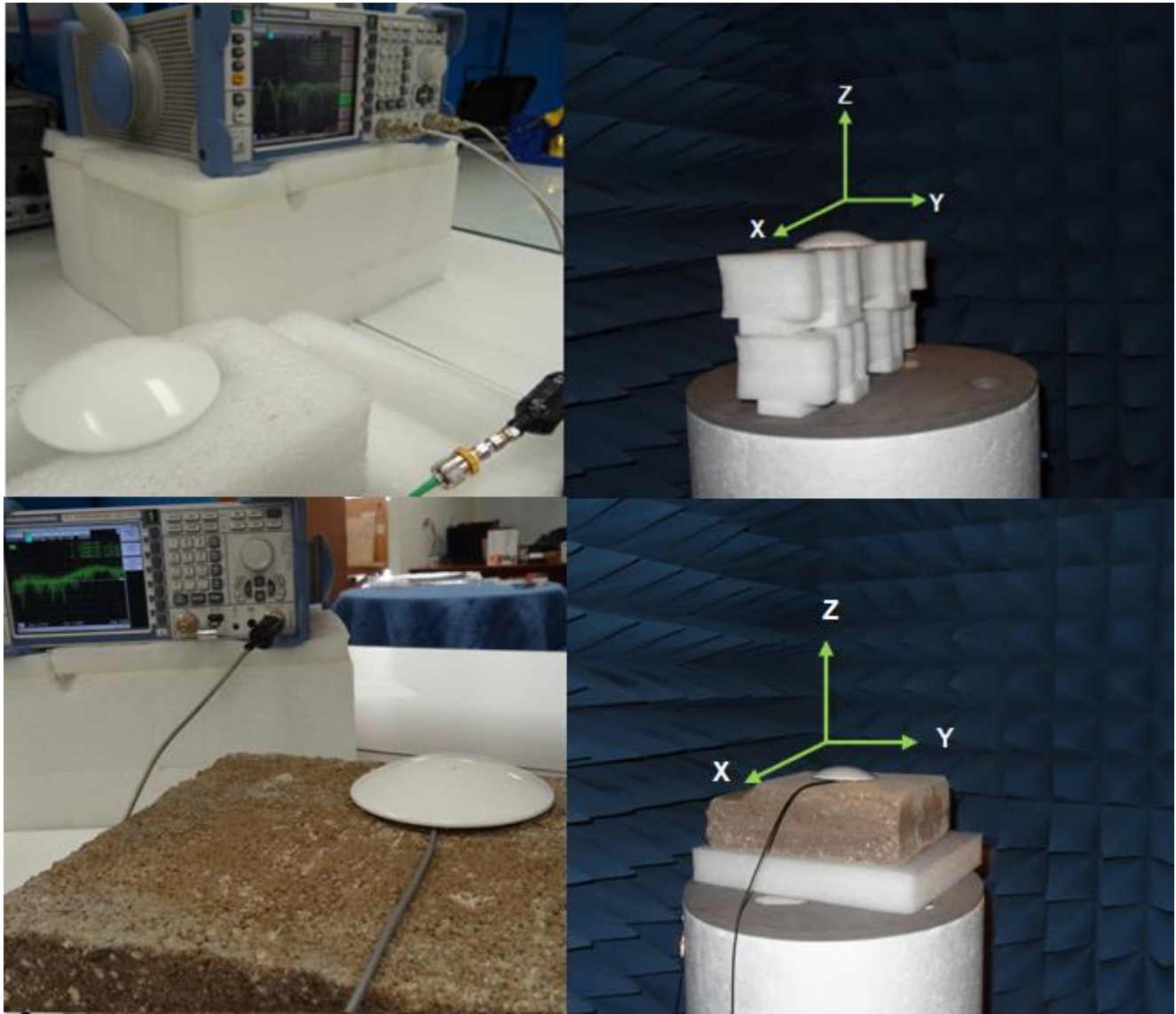

Figure 1. Impedance (left hand) and peak gain, efficiency and radiation pattern measurements (right hand).

4. Antenna Parameters

4.1. Return Loss

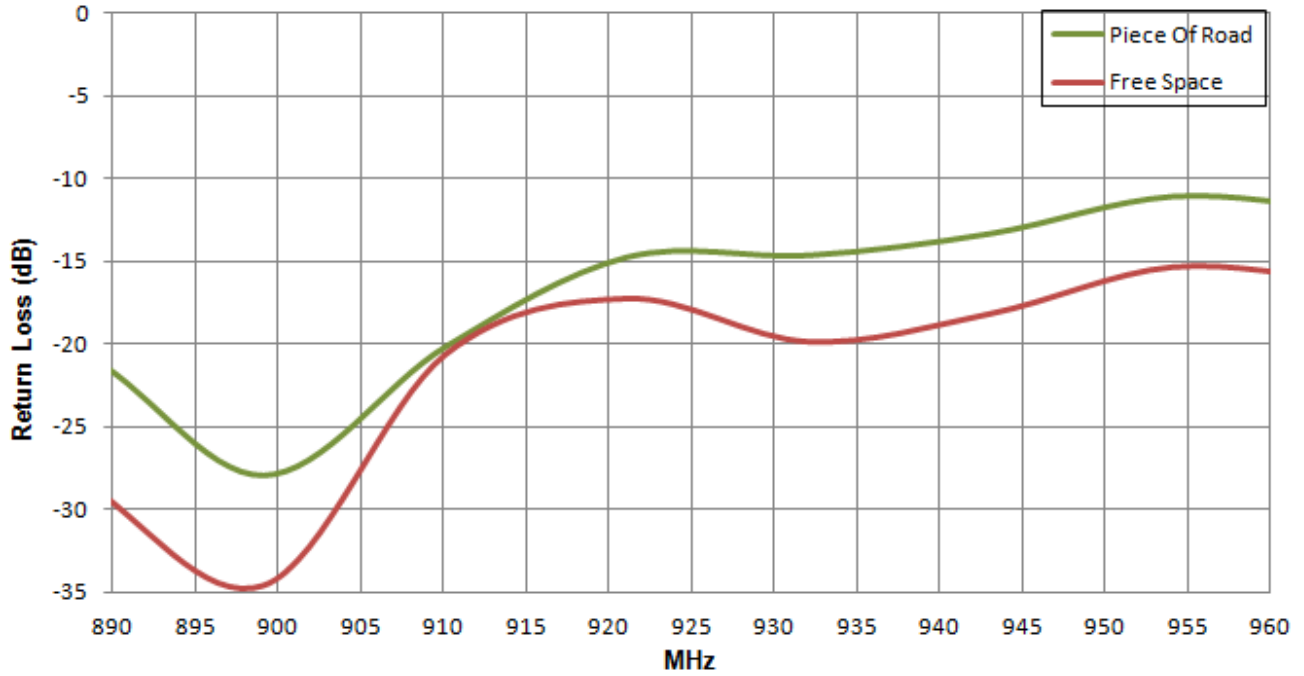

Figure 2. Return Loss 915MHz Road Marker in Free Space and on Piece of Road.

4.2. Efficiency

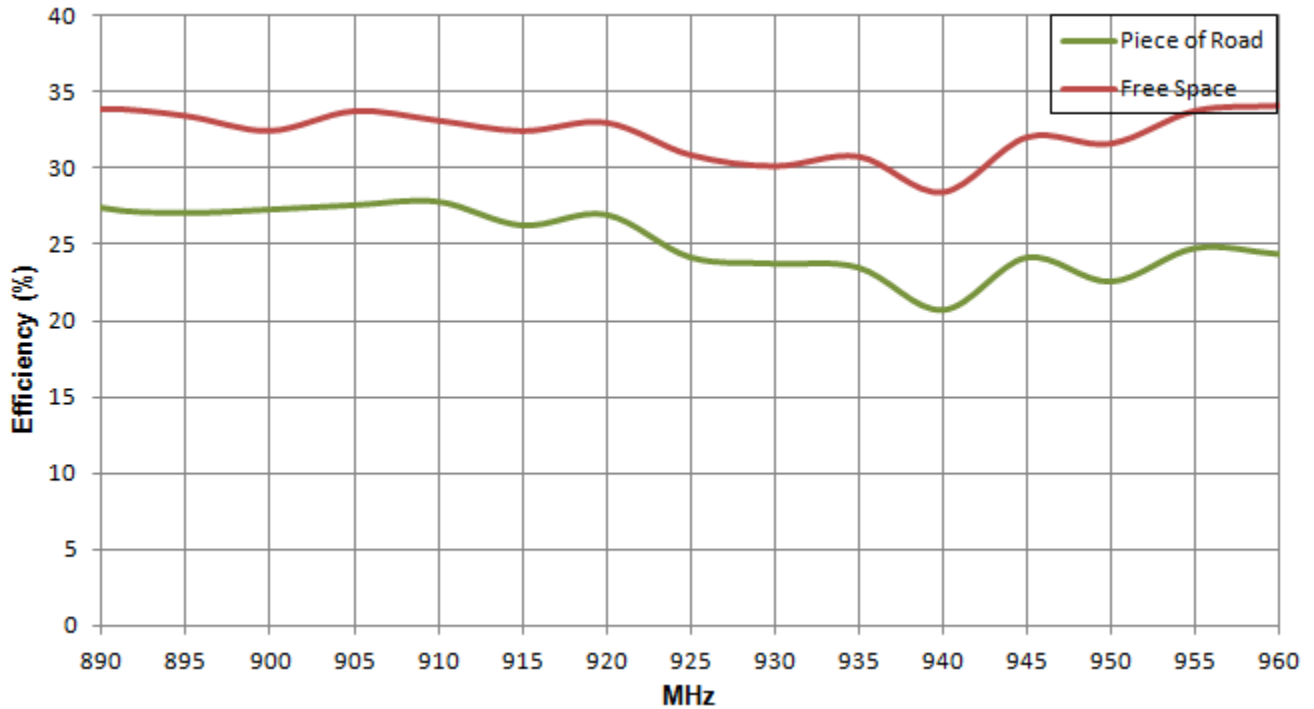

Figure 3. Efficiency of the 915MHz Road Marker in Free Space and on Piece of Road.

4.3. Peak Gain

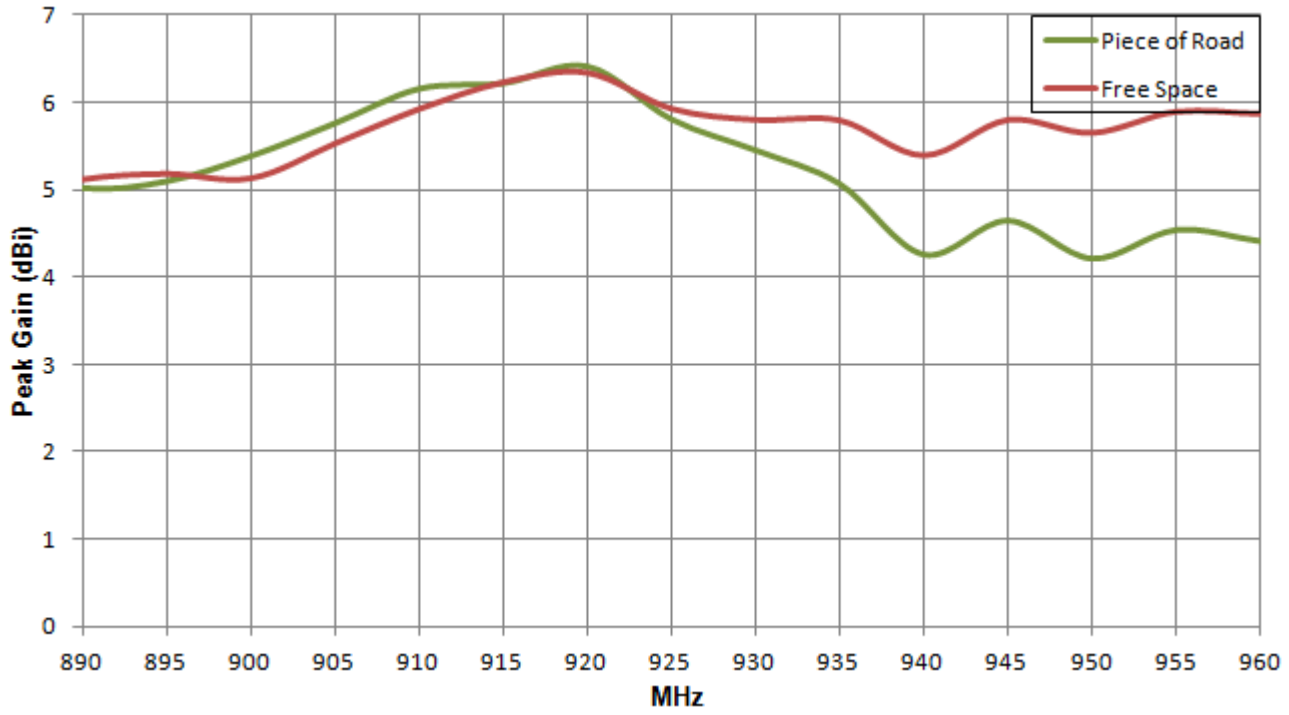

Figure 4. Peak Gain 915MHz Road Marker in Free Space and on Piece of Road

4.4. Radiation Pattern

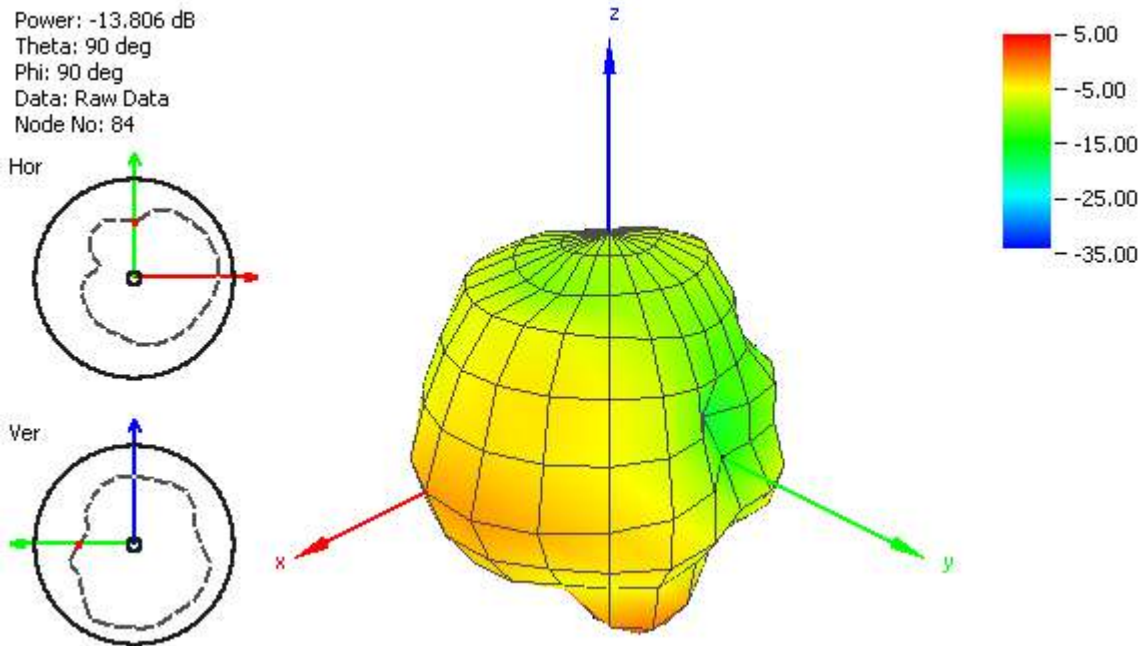

Figure 5. Road Marker ISM Antenna radiation pattern at 900 MHz on Piece of Road.

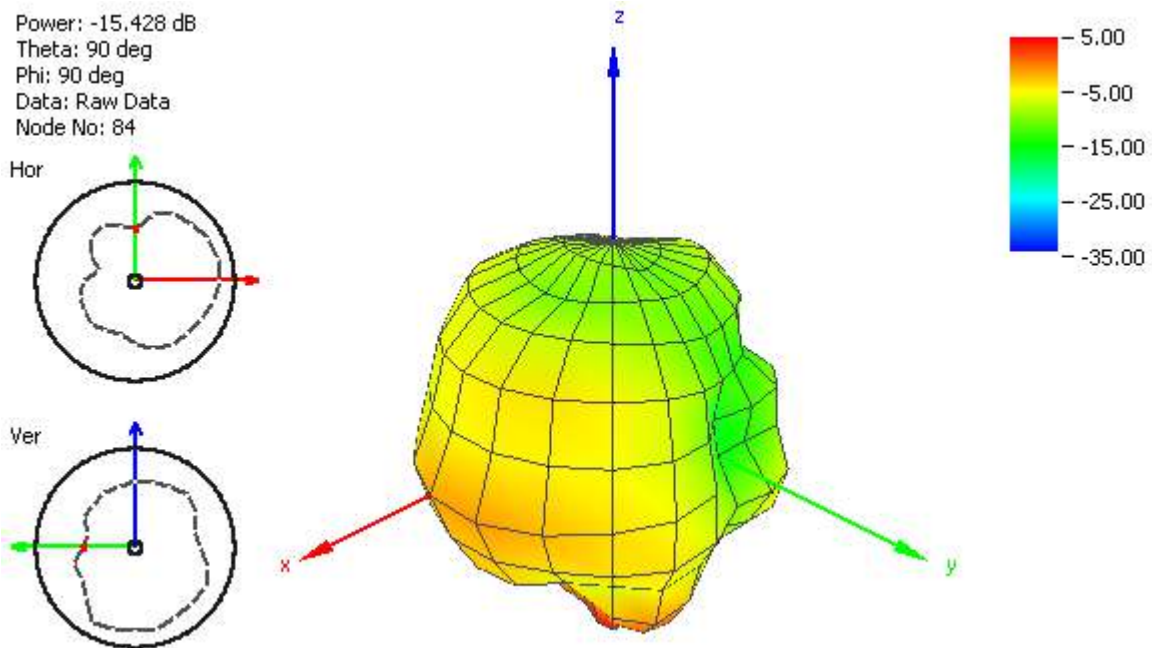

Figure 6. Radiation pattern at 915 MHz on a Piece of Road.

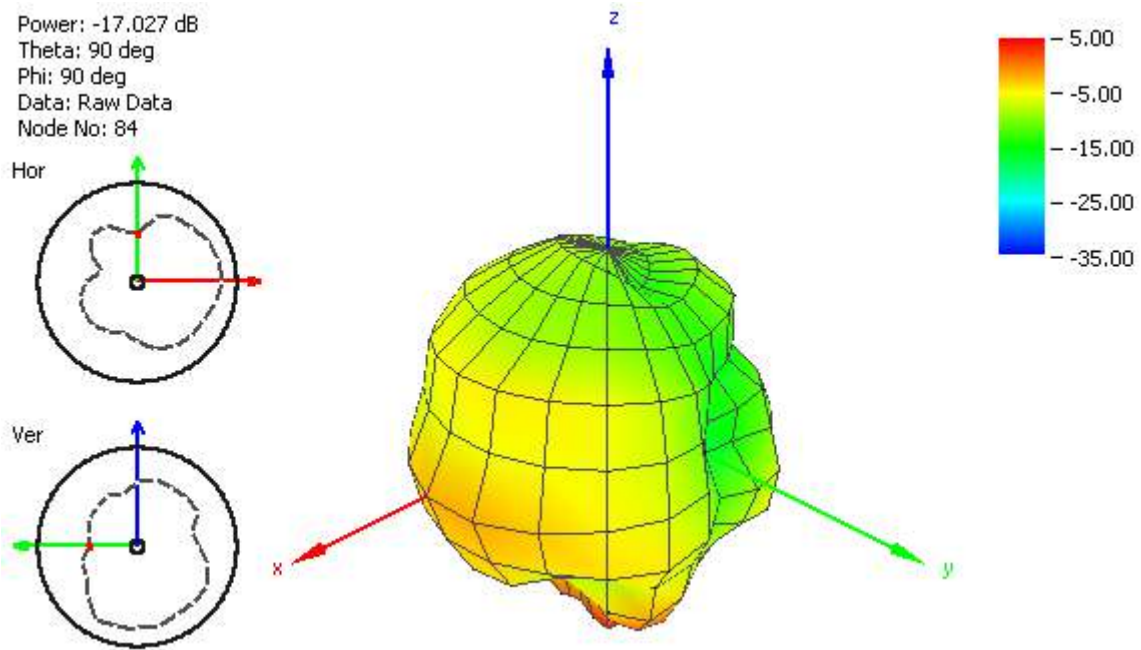

Figure 7. Radiation pattern at 930 MHz on a Piece of Road.

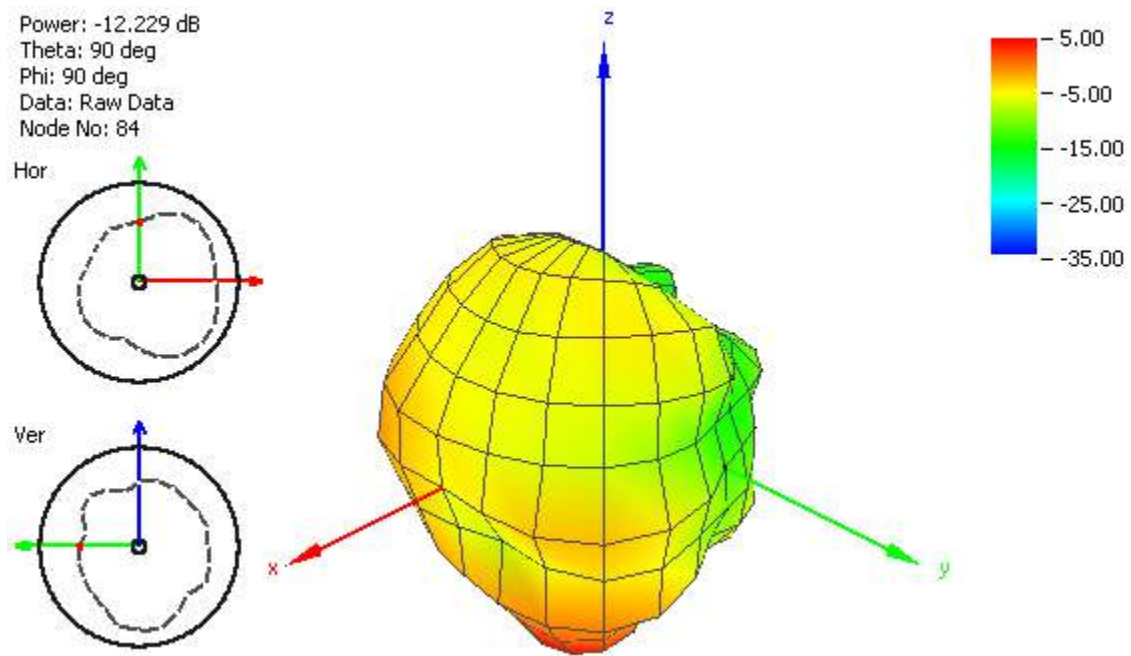

Figure 8. Radiation pattern at 900 MHz in Free Space.

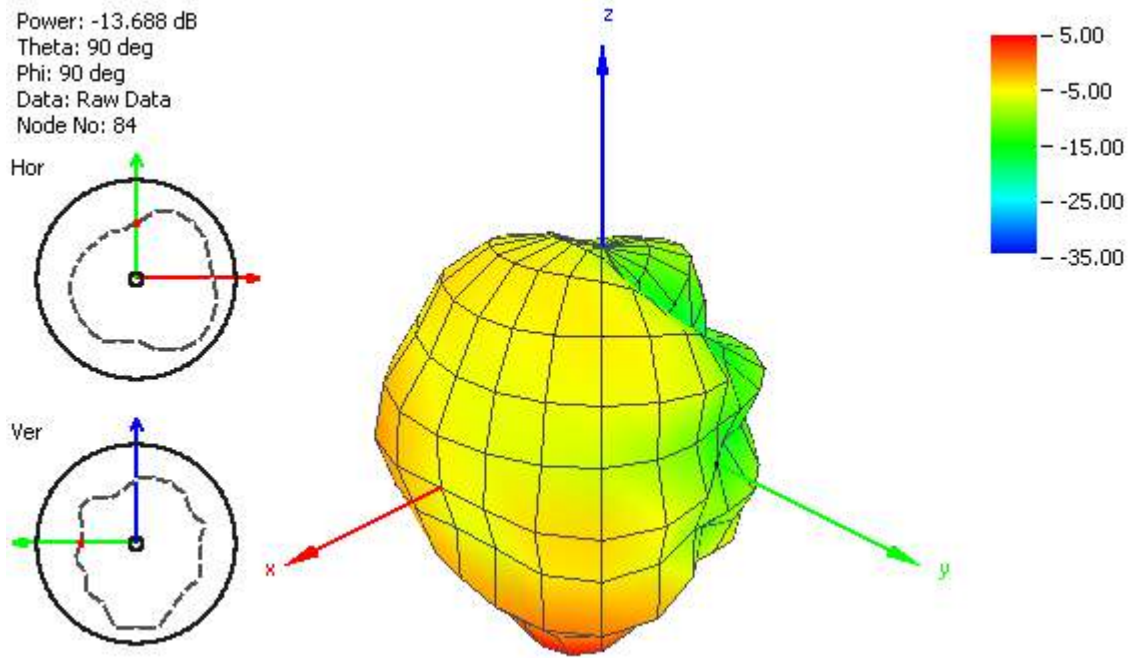

Figure 9. Radiation pattern at 915 MHz in Free Space.

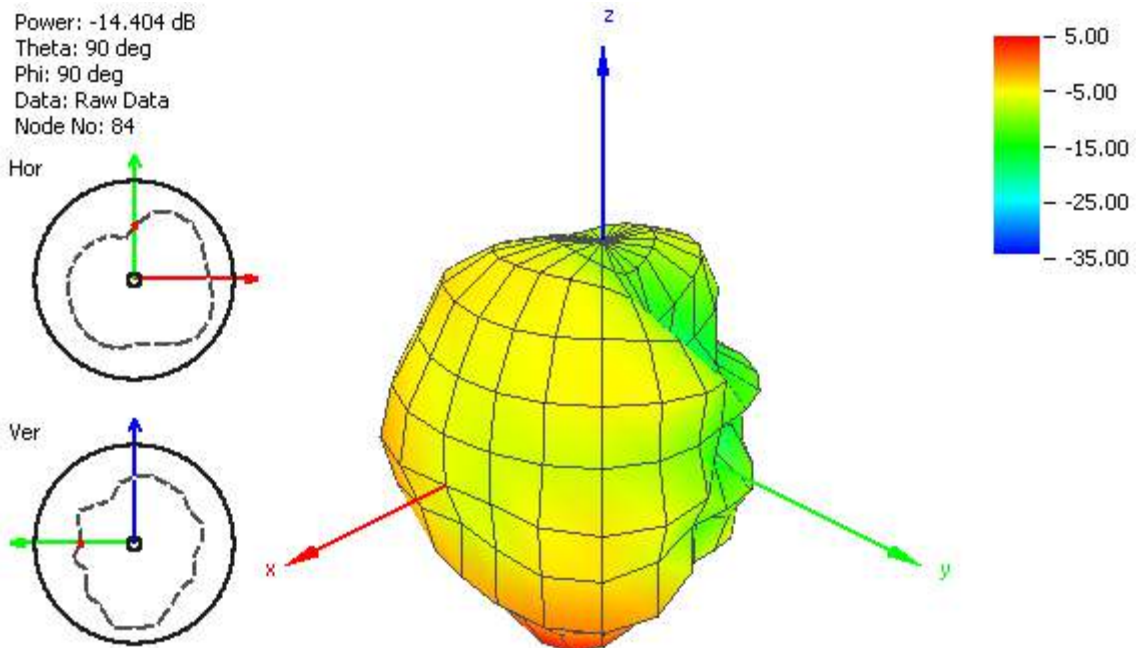
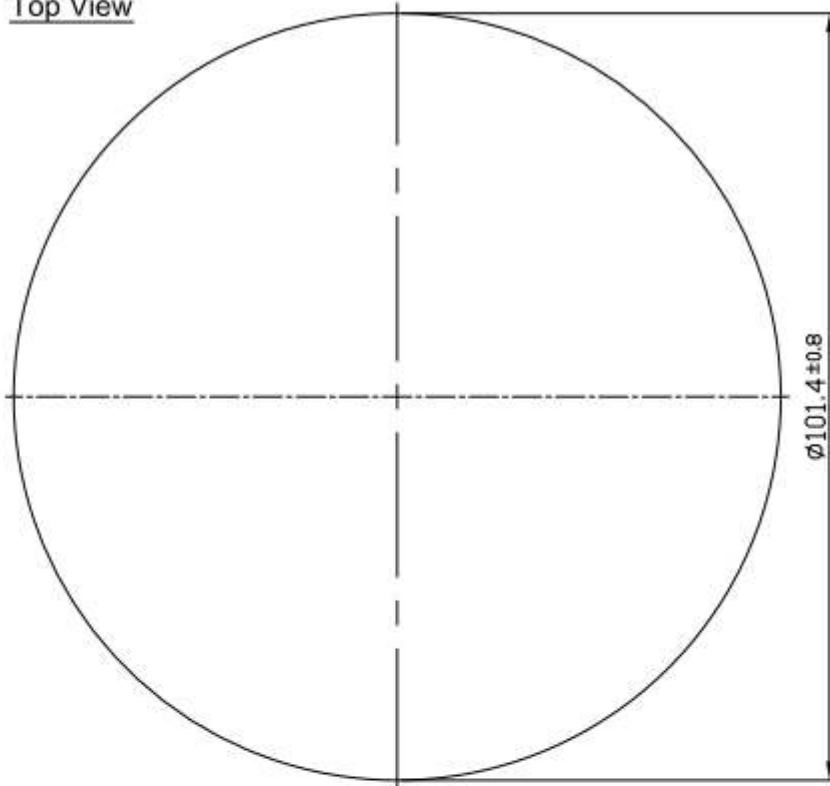

Figure 10. Radiation pattern at 930 MHz in Free Space.

5. MECHANICAL DRAWING

5.1 RI.01 Antenna

Top View



Front View

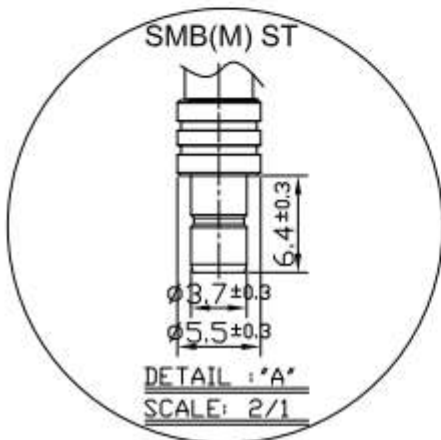
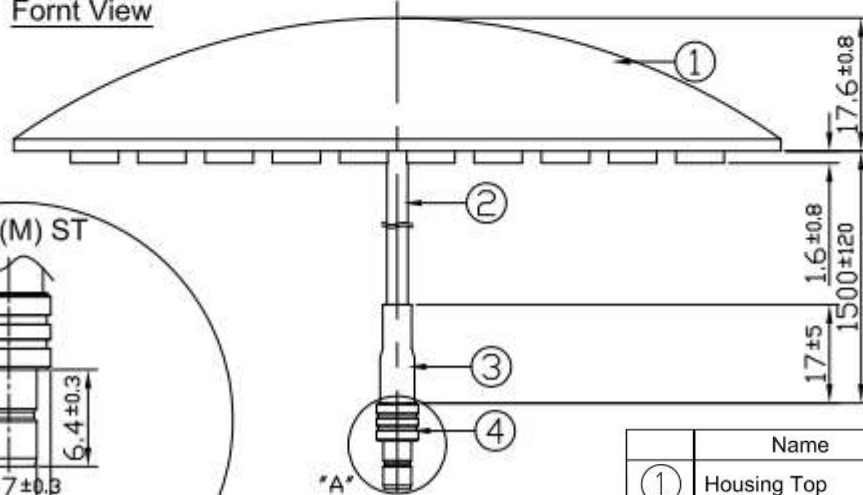

	Name	Material	Finish	QTY
①	Housing Top	PP	White	1
②	WY100 Coaxial Cable	PVC	Black	1
③	Heat Shrink Tube	PE	Black	1
④	SMB(M) ST	Brass	Gold	1

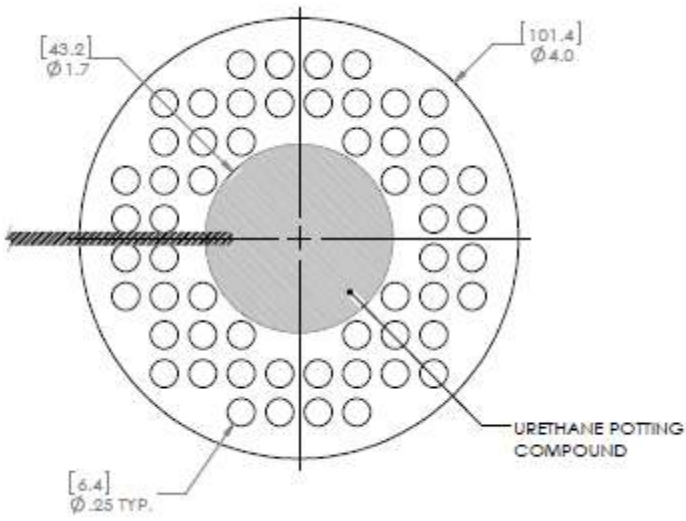

Note: Configuration of bumps or protrusions subject to change without notice

Unit: mm (unless stated otherwise)

5.2 CAB.826 Cable Assembly

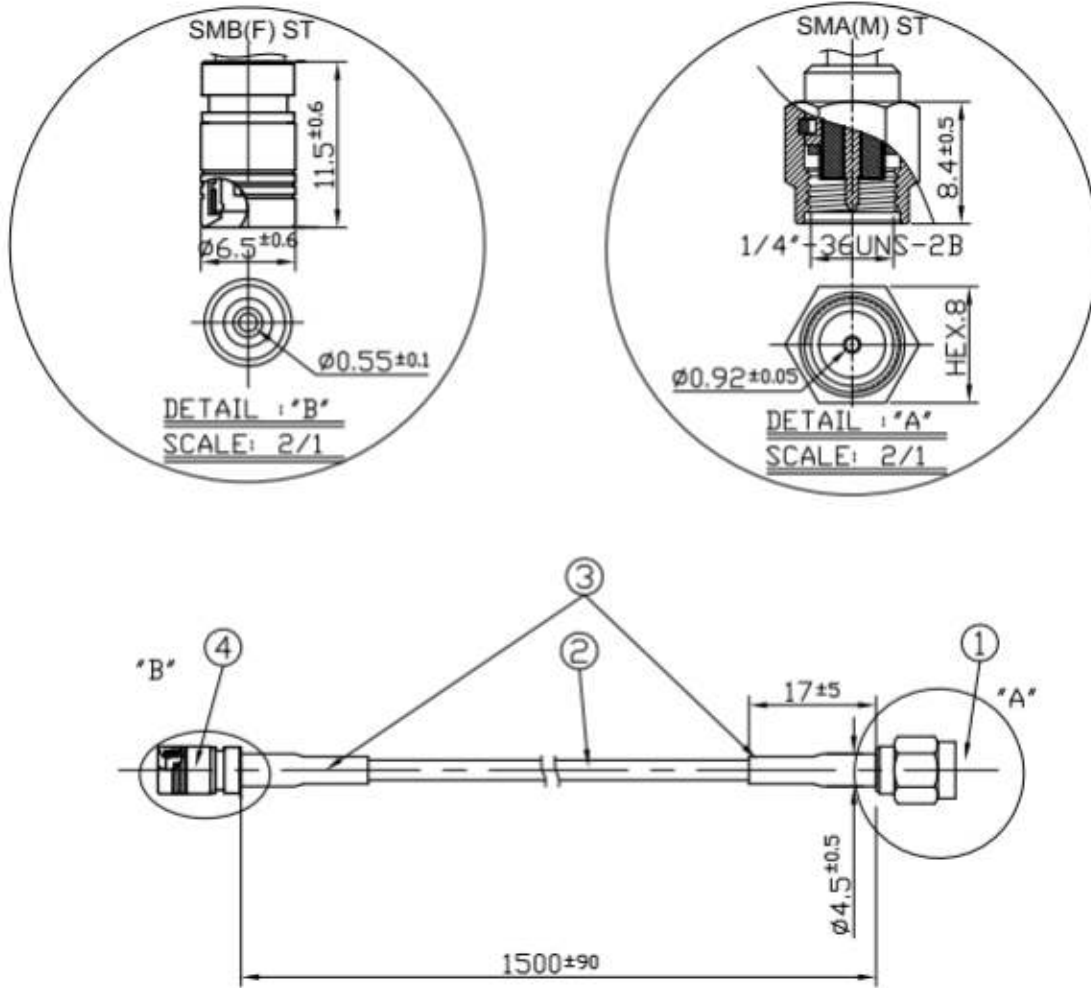

	Name	Material	Finish
1	SMA(M)ST	Brass	Gold
2	WY-100 Coaxial Cable	PVC	Black
3	Heat Shrink Tube	PE	Black
4	SMB(F) Plug ST	Brass	Gold

Taoglas makes no warranties based on the accuracy or completeness of the contents of this document and reserves the right to make changes to specifications and product descriptions at any time without notice. Taoglas reserves all rights to this document and the information contained herein.

Reproduction, use or disclosure to third parties without express permission is strictly prohibited.

Copyright © Taoglas Ltd.