



MIC94044/5

28mΩ R_{DS(ON)} 3A High Side Load Switch
in 1.2mm x 1.2mm MLF[®] Package

General Description

The MIC94044 and MIC94045 are high-side load switches designed to operate from 1.7V to 5.5V input voltage. The load switch pass element is an internal 28mΩ R_{DS(ON)} P-channel MOSFET which enables the device to support up to 3A of continuous current. Additionally, the load switch supports 1.5V logic level control and shutdown features in a tiny 1.2mm x 1.2mm 4 pin MLF[®] package.

The MIC94044/5 provides a slew rate controlled soft-start turn-on of 1ms (typical) to prevent an in-rush current event from pulling down the input supply voltage.

The MIC94045 features an active load discharge circuit which switches in a 200Ω load when the switch is disabled to automatically discharge a capacitive load.

Internal level shift circuitry allows low voltage logic signals to switch higher supply voltages. The enable voltage can be as high as 5.5V and is not limited by the input voltage.

The MIC94044/5 operating voltage range makes them ideal for Lithium ion and NiMH/NiCad/Alkaline battery powered systems, as well as non-battery powered applications. The devices provide low quiescent current and low shutdown current to maximize battery life.

Data sheets and support documentation can be found on Micrel's web site at: www.micrel.com.

Features

- 28mΩ R_{DS(ON)}
- 3A continuous operating current
- 1.2mm x 1.2mm space saving 4-pin MLF[®] package
- 1.7V to 5.5V input voltage range
- Internal level shift for CMOS/TTL control logic
- Ultra low quiescent current
- Micro-power shutdown current
- Soft-Start: 1ms
- Load discharge circuit: MIC94045
- Ultra fast turn off time
- Junction operating temperature from -40°C to +125°C

Applications

- Solid State Drives (SSD)
- Cellular phones
- Portable Navigation Devices (PND)
- Personal Media Players (PMP)
- Ultra Mobile PCs
- Portable instrumentation
- Other Portable applications
- PDAs
- Industrial and DataComm equipment

Typical Application

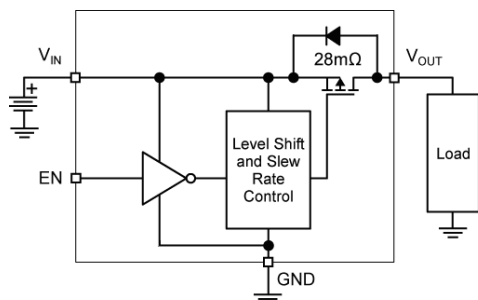

MIC94044 (1ms soft-start)

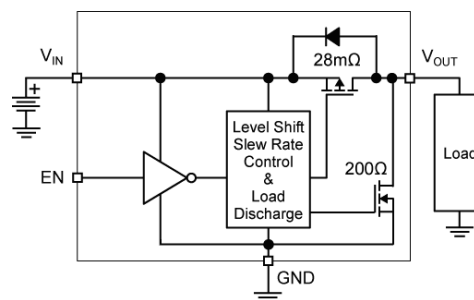

MIC94045 (1ms soft-start with auto-discharge)

MLF and *MicroLeadFrame* are registered trademarks of Amkor Technology, Inc.

Micrel Inc. • 2180 Fortune Drive • San Jose, CA 95131 • USA • tel +1 (408) 944-0800 • fax + 1 (408) 474-1000 • <http://www.micrel.com>

Ordering Information

Part Number	Marking	Soft-Start	Load Discharge	Package
MIC94044YFL	$\overline{P5}$	1ms		4-Pin 1.2mm x 1.2mm MLF [®]
MIC94045YFL	$\overline{P6}$	1ms	—	4-Pin 1.2mm x 1.2mm MLF [®]

Notes:

1. MLF[®] Pin 1 Identifier symbol is “●”.
2. Over bar symbol ($\overline{\quad}$) may not be to scale.
3. MLF[®] is a GREEN RoHS-compliant package. Lead finish is NiPdAu. Mold compound is Halogen Free.

Pin Configuration

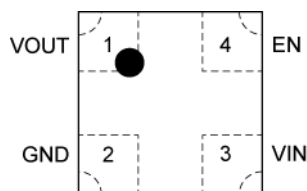

4-Pin 1.2mm x 1.2mm MLF[®]
(Top View)

Pin Description

Pin Number	Pin Name	Description
1	V _{OUT}	Drain of P-channel MOSFET.
2	GND	Ground should be connected to electrical ground.
3	V _{IN}	Source of P-channel MOSFET.
4	EN	Enable (Input): Active-high CMOS/TTL control input for switch. Do not leave floating.

Absolute Maximum Ratings ⁽¹⁾

Input Voltage (V_{IN})	+6V
Enable Voltage (V_{EN})	+6V
Continuous Drain Current (I_D) ⁽³⁾	
$T_A = 25^\circ\text{C}$	$\pm 3\text{A}$
$T_A = 85^\circ\text{C}$	$\pm 2\text{A}$
Pulsed Drain Current (I_{DP}) ⁽⁴⁾	$\pm 6.0\text{A}$
Continuous Diode Current (I_S) ⁽⁵⁾	-50mA
Storage Temperature (T_S)	-55°C to +150°C
ESD Rating – HBM ⁽⁶⁾	3kV

Operating Ratings ⁽²⁾

Input Voltage (V_{IN})	+1.7 to +5.5V
Junction Temperature (T_J)	-40°C to +125°C
Package Thermal Resistance	
1.2mm x 1.2mm MLF [®] -4L(θ_{JC})	90°C/W

Electrical Characteristics ⁽⁷⁾

$T_A = 25^\circ\text{C}$, bold values indicate $-40^\circ\text{C} < T_J < +85^\circ\text{C}$, unless noted.

Symbol	Parameter	Condition	Min	Typ	Max	Units
V_{EN_TH}	Enable Threshold Voltage	$V_{IN} = 1.7\text{V to } 4.5\text{V}$, $I_D = -250\mu\text{A}$	0.4		1.2	V
I_Q	Quiescent Current	$V_{IN} = V_{EN} = 5.5\text{V}$, $I_D = \text{OPEN}$ Measured on V_{IN}		2.25	10	μA
I_{EN}	Enable Input Current	$V_{IN} = V_{EN} = 5.5\text{V}$, $I_D = \text{OPEN}$		0.1	1	μA
I_{SHUT-Q}	Quiescent Current (shutdown)	$V_{IN} = +5.5\text{V}$, $V_{EN} = 0\text{V}$, $I_D = \text{OPEN}$ Measured on V_{IN}		0.1	1	μA
$I_{SHUT-SWITCH}$	OFF State Leakage Current	$V_{IN} = +5.5\text{V}$, $V_{EN} = 0\text{V}$, $I_D = \text{SHORT}$ Measured on V_{OUT} , ⁽⁷⁾		0.1	1	μA
$R_{DS(ON)}$	P-Channel Drain to Source ON Resistance	$V_{IN} = +5.0\text{V}$, $I_D = -100\text{mA}$, $V_{EN} = 1.5\text{V}$		28	55	m Ω
		$V_{IN} = +4.5\text{V}$, $I_D = -100\text{mA}$, $V_{EN} = 1.5\text{V}$		30	60	m Ω
		$V_{IN} = +3.6\text{V}$, $I_D = -100\text{mA}$, $V_{EN} = 1.5\text{V}$		33	65	m Ω
		$V_{IN} = +2.5\text{V}$, $I_D = -100\text{mA}$, $V_{EN} = 1.5\text{V}$		45	90	m Ω
		$V_{IN} = +1.8\text{V}$, $I_D = -100\text{mA}$, $V_{EN} = 1.5\text{V}$		72	145	m Ω
		$V_{IN} = +1.7\text{V}$, $I_D = -100\text{mA}$, $V_{EN} = 1.5\text{V}$		82	160	m Ω
$R_{SHUTDOWN}$	Turn-Off Resistance	$V_{IN} = +3.6\text{V}$, $I_{TEST} = 1\text{mA}$, $V_{EN} = 0\text{V}$ MIC94045		200	400	Ω

Dynamic

t_{ON_DLY}	Turn-On Delay Time	$V_{IN} = +3.6\text{V}$, $I_D = -100\text{mA}$, $V_{EN} = 1.5\text{V}$	0.2	0.85	1.5	ms
t_{ON_RISE}	Turn-On Rise Time	$V_{IN} = +3.6\text{V}$, $I_D = -100\text{mA}$, $V_{EN} = 1.5\text{V}$	0.4	1	1.5	ms
t_{OFF_DLY}	Turn-Off Delay Time	$V_{IN} = +3.6\text{V}$, $I_D = -100\text{mA}$, $V_{EN} = 0\text{V}$		100	200	ns
t_{OFF_FALL}	Turn-Off Fall Time	$V_{IN} = +3.6\text{V}$, $I_D = -100\text{mA}$, $V_{EN} = 0\text{V}$ (No Output Capacitor)		20	100	ns

Notes:

- Exceeding the absolute maximum rating may damage the device.
- The device is not guaranteed to function outside its operating rating.
- With thermal contact to PCB. See power dissipation considerations section.
- Pulse width $< 300\mu\text{s}$ with $< 2\%$ duty cycle.
- Continuous body diode current conduction (reverse conduction, i.e. V_{OUT} to V_{IN}) is not recommended.
- Devices are ESD sensitive. Handling precautions recommended. HBM (Human body model), 1.5k Ω in series with 100pF.
- Measured on the MIC94044YFL.

Typical Characteristics

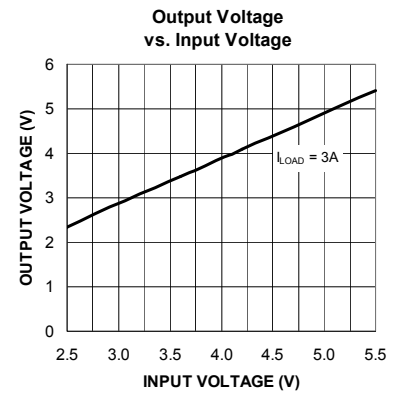
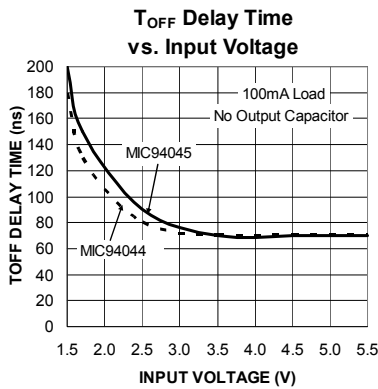
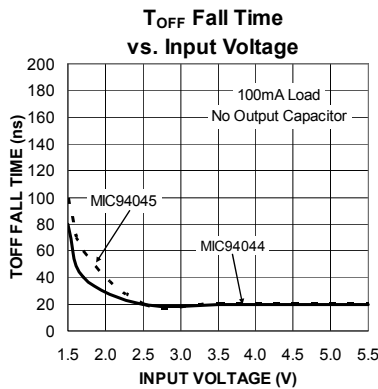
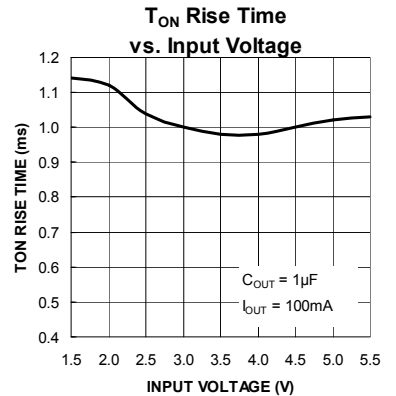
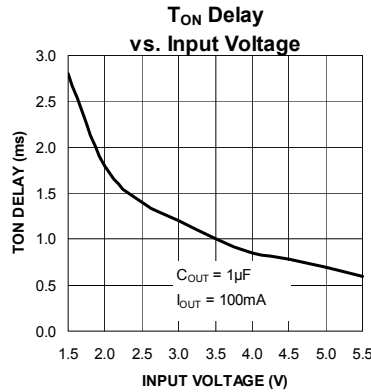
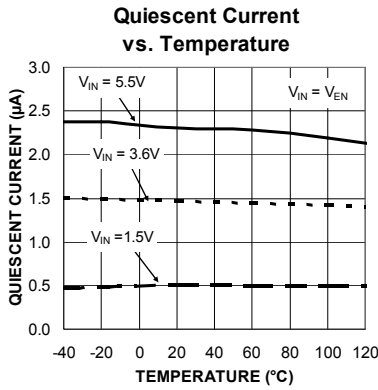
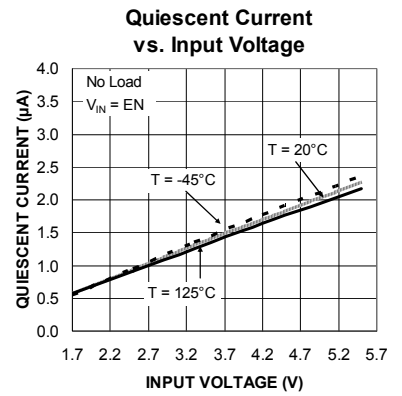
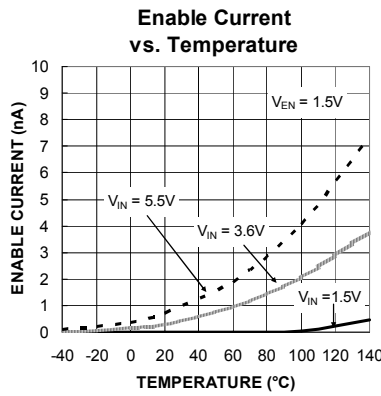
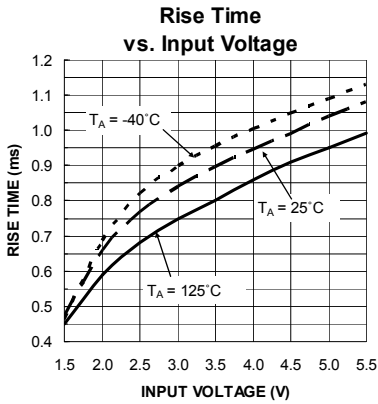
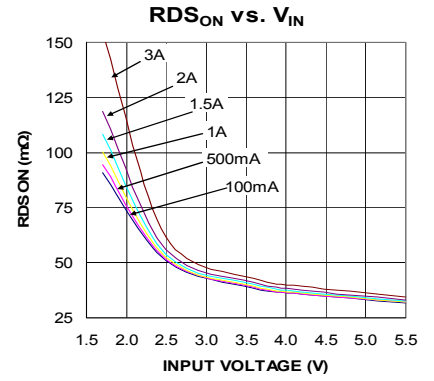
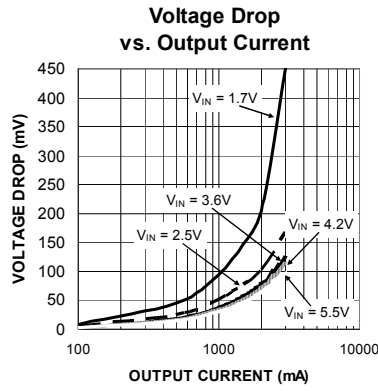
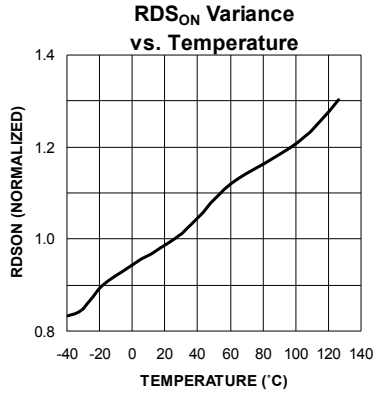

Functional Characteristics

MIC94044/5 Turn On

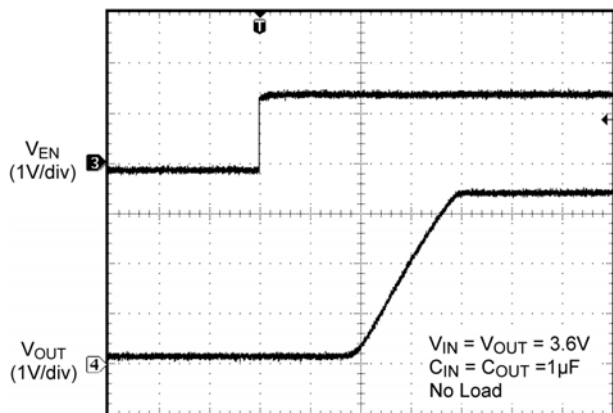

Time (400µs/div)

MIC94044/5 Turn On

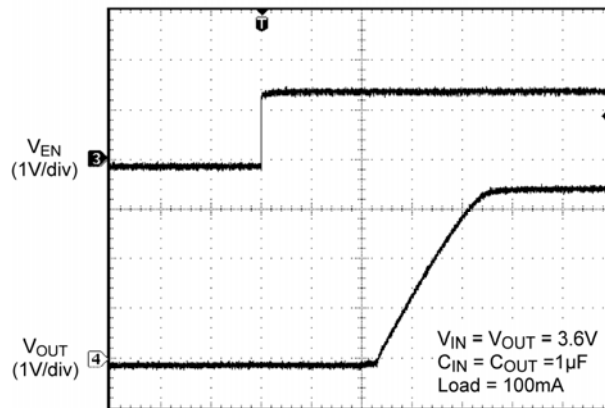

Time (400µs/div)

MIC94044 Turn Off

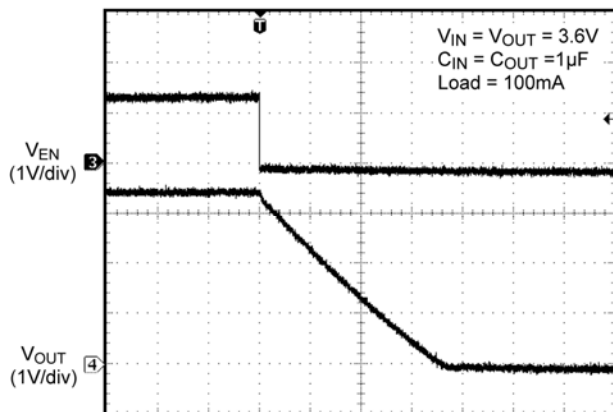

Time (20µs/div)

MIC94045 Turn Off

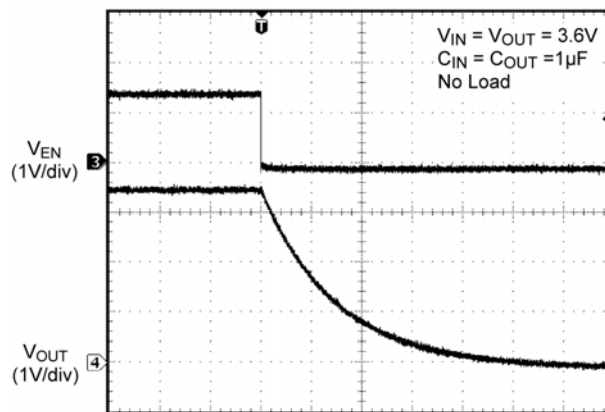

Time (20µs/div)

Application Information

Power Switch SOA

The safe operating area (SOA) curve represents the boundary of maximum safe operating current and maximum safe operating ambient temperature.

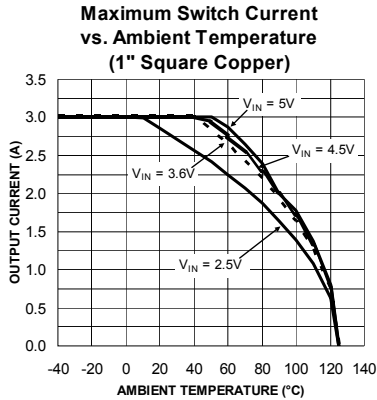

Figure 1: SOA Graph

The curves above show the SOA for various values of V_{IN} , mounted on a typical 1 layer, 1 square inch copper board.

Power Dissipation Considerations

As with all power switches, the current rating of the switch is limited mostly by the thermal properties of the package and the PCB it is mounted on. There is a simple ohms law type relationship between thermal resistance, power dissipation and temperature, which are analogous to an electrical circuit:

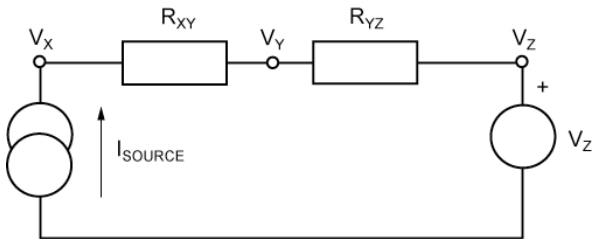

Figure 2: Simple Electrical Circuit

From this simple circuit we can calculate V_x if we know I_{SOURCE} , V_z and the resistor values, R_{XY} and R_{YZ} using the equation:

$$V_x = I_{SOURCE} (R_{XY} + R_{YZ}) + V_z$$

Thermal circuits can be considered using these same rules and can be drawn similarly by replacing current sources with power dissipation (in Watts), resistance with thermal resistance (in $^{\circ}C/W$) and voltage sources with temperature (in $^{\circ}C$).

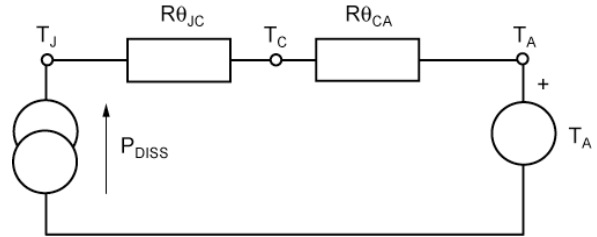

Figure 3: Simple Thermal Circuit

Now replacing the variables in the equation for V_x , we can find the junction temperature (T_J) from power dissipation, ambient temperature and the known thermal resistance of the PCB ($R_{\theta_{CA}}$) and the package ($R_{\theta_{JC}}$).

$$T_J = P_{DISS} \times (R_{\theta_{JC}} + R_{\theta_{CA}}) + T_A$$

P_{DISS} is calculated as $I_{SWITCH}^2 \times R_{SWmax}$. $R_{\theta_{JC}}$ is found in the operating ratings section of the datasheet and $R_{\theta_{CA}}$ (the PCB thermal resistance) values for various PCB copper areas is discussed in the document "Designing with Low Dropout Voltage Regulators" available from the Micrel website (LDO Application Hints).

Example:

A switch is intended to drive a 2A load and is placed on a printed circuit board which has a ground plane area of at least 25mm x 25mm (625mm²). The Voltage source is a Li-ion battery with a lower operating threshold of 3V and the ambient temperature of the assembly can be up to 50°C.

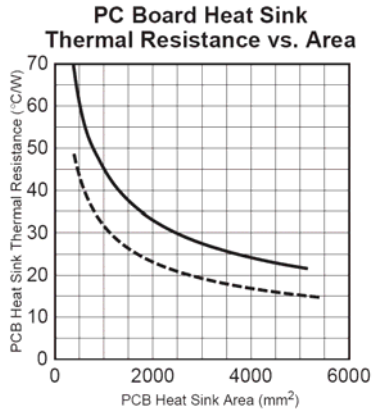

Figure 4: Excerpt from the LDO Book

Summary of variables:

$$I_{SW} = 2A$$

$$V_{IN} = 3V \text{ to } 4.2V$$

$$T_A = 50^\circ C$$

$$R_{\theta_{JC}} = 90^\circ C/W \text{ from Datasheet}$$

$$R_{\theta_{CA}} = 53^\circ C/W \text{ Read from Graph in Figure 4}$$

$$P_{DISS} = I_{SW}^2 \times R_{SWmax}$$

The worst case switch resistance (R_{SWmax}) at the lowest V_{IN} of 3V is not available in the datasheet, so the next lower value of V_{IN} is used.

$$R_{SWmax} @ 2.5V = 90m\Omega$$

If this were a figure for worst case R_{SWmax} for 25°C, an additional consideration is to allow for the maximum junction temperature of 125°C, the actual worst case resistance in this case can be 30% higher (See R_{DSON} variance vs. temperature graph). However, 90mΩ is the maximum over temperature.

Therefore:

$$T_J = 2^2 \times 0.090 \times (90+53) + 50$$

$$T_J = 101^\circ C$$

This is below the maximum 125°C.

Package Information

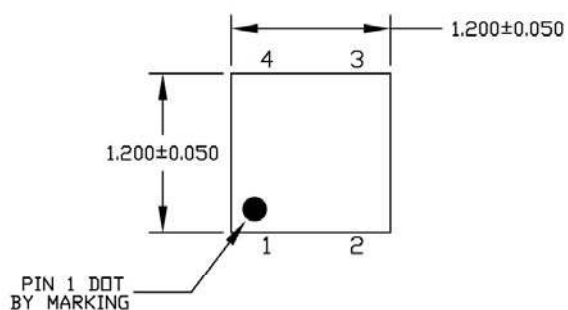

TOP VIEW

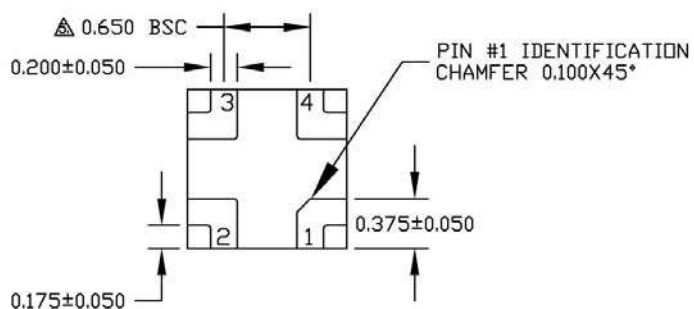

BOTTOM VIEW

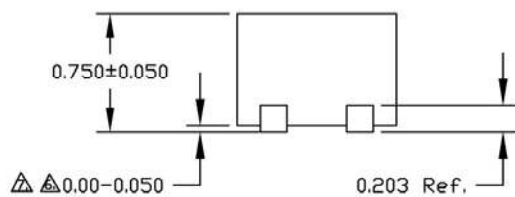

SIDE VIEW

NOTE:

1. ALL DIMENSIONS ARE IN MILLIMETERS.
 2. MAX. PACKAGE WARPAGE IS 0.05 mm.
 3. MAXIMUM ALLOWABLE BURRS IS 0.076 mm IN ALL DIRECTIONS.
 4. PIN #1 ID ON TOP WILL BE LASER/INK MARKED.
- △ DIMENSION APPLIES TO METALIZED TERMINAL AND IS MEASURED BETWEEN 0.20 AND 0.25 mm FROM TERMINAL TIP.
- △ APPLIED ONLY FOR TERMINALS.
- △ APPLIED FOR EXPOSED PAD AND TERMINALS.

4-Pin 1.2mm x 1.2mm MLF®

Recommended Land Pattern

LP # MLF1212D-4LD-LP-9
 All units are in mm
 Tolerance ± 0.05 if not noted

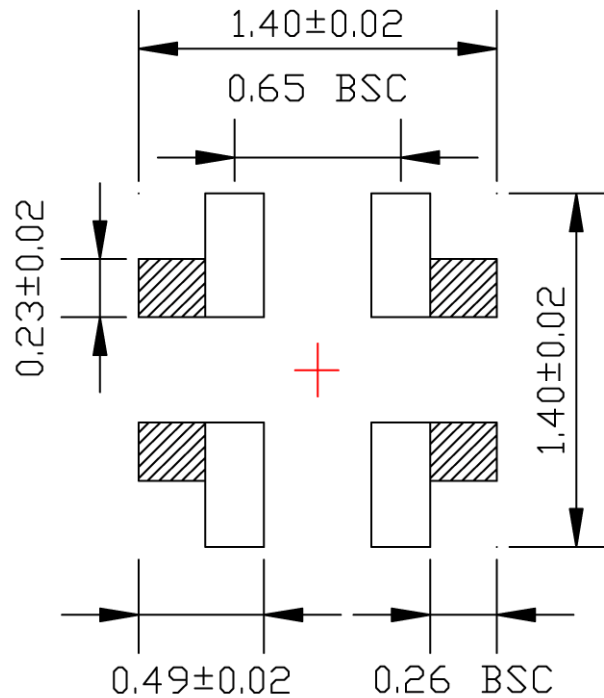

 Optional (For Thermal Improvement)

Disclaimer: This is only a recommendation based on information available to Micrel from its suppliers. Actual land pattern may have to be significantly different due to various materials and processes used in PCB assembly. Micrel makes no representation or warranty of performance based on the recommended land pattern."

4-Pin 1.2mm x 1.2mm MLF[®] Land Pattern

MICREL, INC. 2180 FORTUNE DRIVE SAN JOSE, CA 95131 USA
 TEL +1 (408) 944-0800 FAX +1 (408) 474-1000 WEB <http://www.micrel.com>

Micrel makes no representations or warranties with respect to the accuracy or completeness of the information furnished in this data sheet. This information is not intended as a warranty and Micrel does not assume responsibility for its use. Micrel reserves the right to change circuitry, specifications and descriptions at any time without notice. No license, whether express, implied, arising by estoppel or otherwise, to any intellectual property rights is granted by this document. Except as provided in Micrel's terms and conditions of sale for such products, Micrel assumes no liability whatsoever, and Micrel disclaims any express or implied warranty relating to the sale and/or use of Micrel products including liability or warranties relating to fitness for a particular purpose, merchantability, or infringement of any patent, copyright or other intellectual property right.

Micrel Products are not designed or authorized for use as components in life support appliances, devices or systems where malfunction of a product can reasonably be expected to result in personal injury. Life support devices or systems are devices or systems that (a) are intended for surgical implant into the body or (b) support or sustain life, and whose failure to perform can be reasonably expected to result in a significant injury to the user. A Purchaser's use or sale of Micrel Products for use in life support appliances, devices or systems is a Purchaser's own risk and Purchaser agrees to fully indemnify Micrel for any damages resulting from such use or sale.

© 2011 Micrel, Incorporated.