



## HIGH ISOLATION SPDT NON-REFLECTIVE SWITCH, DC - 4 GHz

### Typical Applications

The HMC349MS8G / HMC349MS8GE is ideal for:

- Basestation Infrastructure
- MMDS & 3.5 GHz WLL
- CATV/CMTS
- Test Instrumentation

### Features

- High Isolation: 70 dB @ 1 GHz  
57 dB @ 2 GHz
- Single Positive Control: 0/+5V
- +52 dBm Input IP3
- Non-Reflective Design
- All Off State
- Ultra Small MS8G SMT Package: 14.8 mm<sup>2</sup>
- Included in the HMC-DK005 Designer's Kit

### Functional Diagram

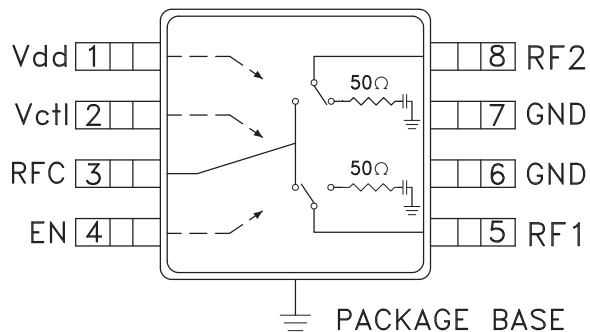

### General Description

The HMC349MS8G & HMC349MS8GE are high isolation non-reflective DC to 4 GHz GaAs MESFET SPDT switches in low cost 8 lead MSOP8G surface mount packages with exposed ground paddles. The switch is ideal for cellular/PCS/3G basestation applications yielding 50 to 60 dB isolation, low 0.8 dB insertion loss and +52 dBm input IP3. Power handling is excellent up through the 3.5 GHz WLL band with the switch offering a P1dB compression point of +31 dBm. On-chip circuitry allows a single positive voltage control of 0/+5 Volts at very low DC currents. An enable input (EN) set to logic high will put the switch in an "all off" state.

### Electrical Specifications, $T_A = +25^\circ C$ , $V_{ctl} = 0/+5 Vdc$ , $V_{dd} = +5 Vdc$ , 50 Ohm System

Parameter	Frequency	Min.	Typ.	Max.	Units
Insertion Loss	DC - 1.0 GHz		0.8	1.1	dB
	DC - 2.0 GHz		0.9	1.2	dB
	DC - 3.0 GHz		1.2	1.5	dB
	DC - 4.0 GHz		1.8	2.1	dB
Isolation (RFC to RF1/RF2)	DC - 1.0 GHz	60	70		dB
	DC - 2.0 GHz	54	57		dB
	DC - 3.0 GHz	45	50		dB
	DC - 4.0 GHz	42	47		dB
Return Loss (On State)	DC - 1.0 GHz		23		dB
	DC - 2.0 GHz		18		dB
	DC - 3.0 GHz		13		dB
	DC - 4.0 GHz		8		dB
Return Loss (Off State)	0.5 - 2.0 GHz		20		dB
	0.5 - 3.0 GHz		17		dB
	0.5 - 4.0 GHz		14		dB
Input Power for 1 dB Compression	0.25 - 4.0 GHz	27	31		dBm
Input Third Order Intercept (Two-Tone Input Power = +7 dBm Each Tone)	0.25 - 1.0 GHz		53		dBm
	1.0 - 2.0 GHz		50		dBm
	2.0 - 3.0 GHz		49		dBm
	3.0 - 4.0 GHz		47		dBm
Switching Speed	DC - 4.0 GHz		40		ns
			120		ns
	tRISE, tFALL (10/90% RF) tON, tOFF (50% CTL to 10/90% RF)				

For price, delivery, and to place orders, please contact Hittite Microwave Corporation:  
20 Alpha Road, Chelmsford, MA 01824 Phone: 978-250-3343 Fax: 978-250-3373  
Order On-line at [www.hittite.com](http://www.hittite.com)



## HIGH ISOLATION SPDT NON-REFLECTIVE SWITCH, DC - 4 GHz

**Insertion Loss**

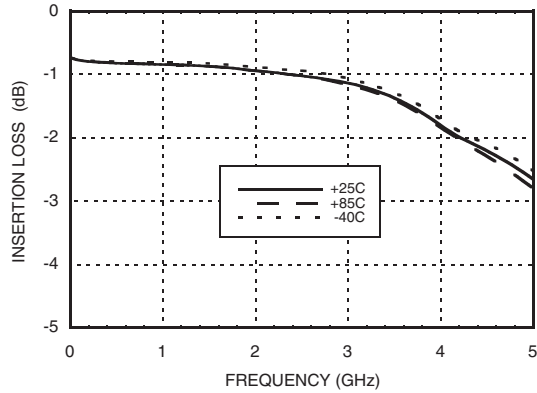

**Return Loss**

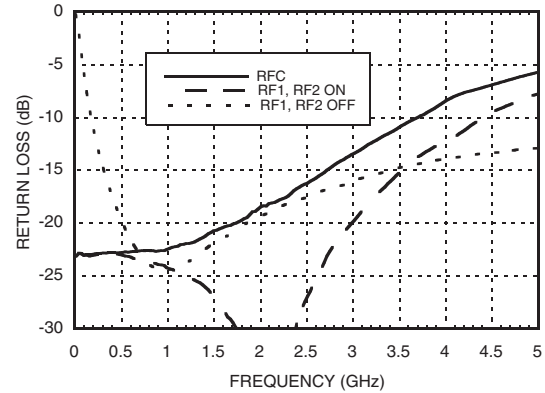

Note: RFC is reflective in "all off" state.

**Isolation Between Ports RFC and RF1 / RF2**

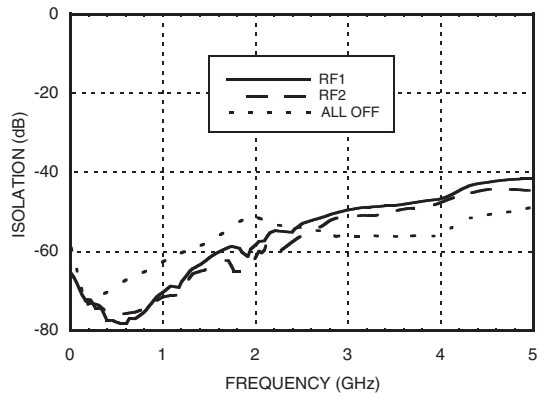

**Isolation Between Ports RF1 and RF2**

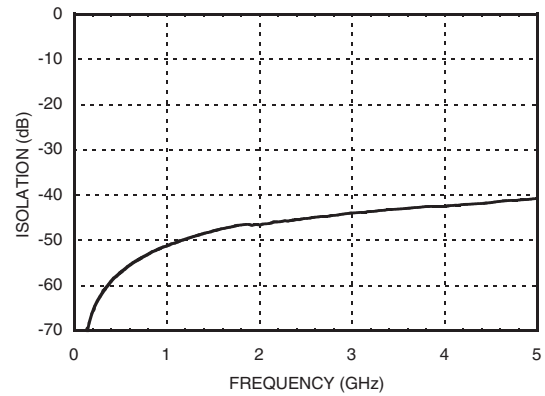

**0.1 and 1 dB Input Compression Point**

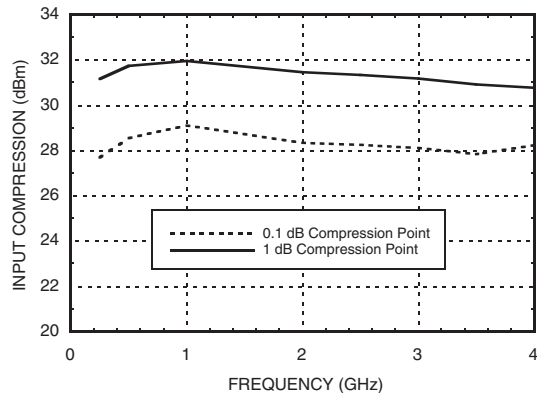

**Input Third Order Intercept Point**

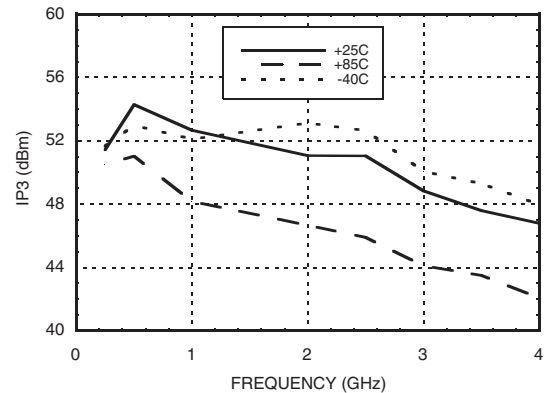



# HMC349MS8G / 349MS8GE

## HIGH ISOLATION SPDT NON-REFLECTIVE SWITCH, DC - 4 GHz

### Absolute Maximum Ratings

RF Input Power (Vctl = 0V/+5V) (0.25 - 4 GHz)	+30 dBm (T = +85 °C)
Supply Voltage Range (Vdd)	+7 Vdc
Control Voltage Range (Vctl)	-1V to Vdd +1V
Hot Switch Power Level (Vdd = +5V)	+30 dBm
Channel Temperature	150 °C
Continuous P <sub>diss</sub> (T = 85 °C) (derate 12 mW/°C above 85 °C)	0.75 W
Thermal Resistance	87 °C/W
Storage Temperature	-65 to +150 °C
Operating Temperature	-40 to +85 °C
ESD Sensitivity (HBM)	Class 1A

Note: DC blocking capacitors are required at ports RFC, RF1 and RF2. Their value will determine the lowest transmission frequency.



**ELECTROSTATIC SENSITIVE DEVICE  
OBSERVE HANDLING PRECAUTIONS**

### Bias Voltage & Current

Vdd Range = +5.0 Vdc ± 10%		
Vdd (Vdc)	I <sub>dd</sub> (Typ.) (mA)	I <sub>dd</sub> (Max.) (mA)
+5.0	2.3	5.0

### TTL/CMOS Control Voltages

State	Bias Condition
Low	0 to +0.8 Vdc @ <1 μA Typical
High	+2.0 to +5.0 Vdc @ 30 μA Typical

### Truth Table

Control Input		Signal Path State	
Vctl	EN	RFC - RF1	RFC - RF2
Low	Low	OFF	ON
High	Low	ON	OFF
Low	High	OFF	OFF
High	High	OFF	OFF

### Outline Drawing

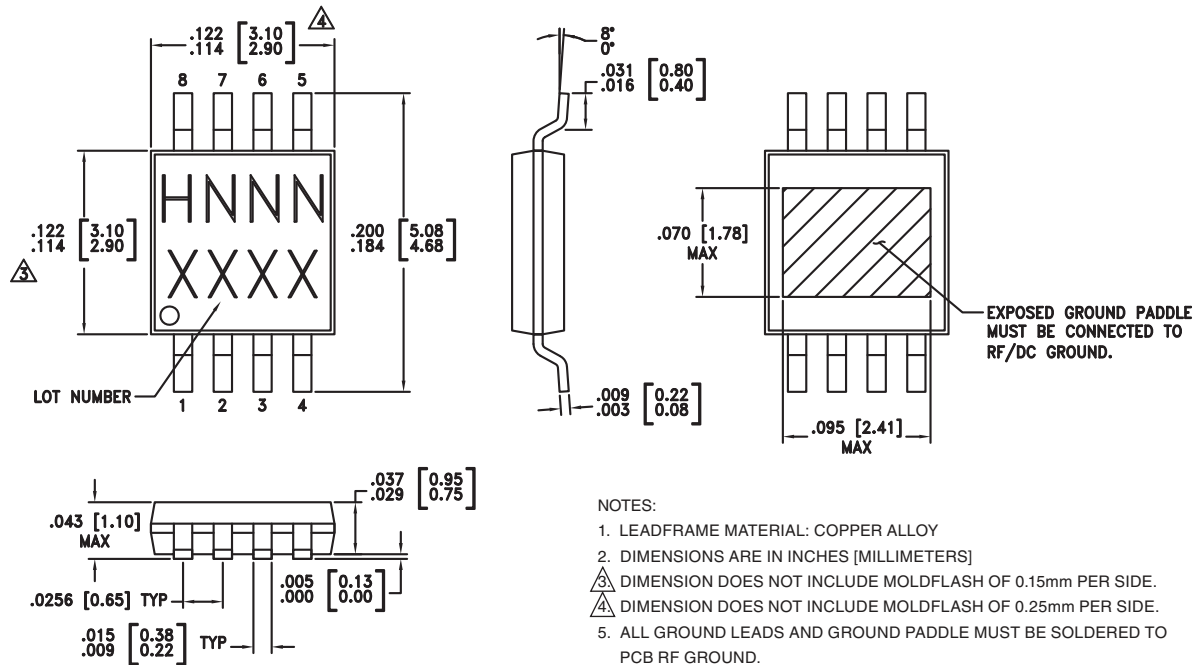

### Package Information

Part Number	Package Body Material	Lead Finish	MSL Rating	Package Marking <sup>[3]</sup>
HMC349MS8G	Low Stress Injection Molded Plastic	Sn/Pb Solder	MSL1 <sup>[1]</sup>	H349 XXXX
HMC349MS8GE	RoHS-compliant Low Stress Injection Molded Plastic	100% matte Sn	MSL1 <sup>[2]</sup>	H349 XXXX



[1] Max peak reflow temperature of 235 °C

[2] Max peak reflow temperature of 260 °C

[3] 4-Digit lot number XXXX

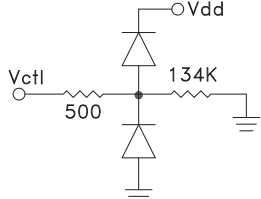
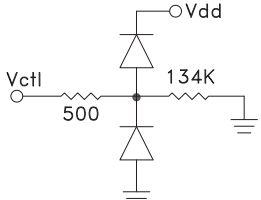

### Pin Descriptions

Pin Number	Function	Description	Interface Schematic
1	Vdd	Supply Voltage.	
2	Vctl	Control input. See truth and control voltage tables.	
3, 5, 8	RFC, RF1, RF2	These pins are DC coupled and matched to 50 Ohms. Blocking capacitors are required.	
4	EN	Enable. See truth and control voltage tables.	
6, 7	GND	Package bottom must also be connected to PCB RF ground.	



### Evaluation PCB

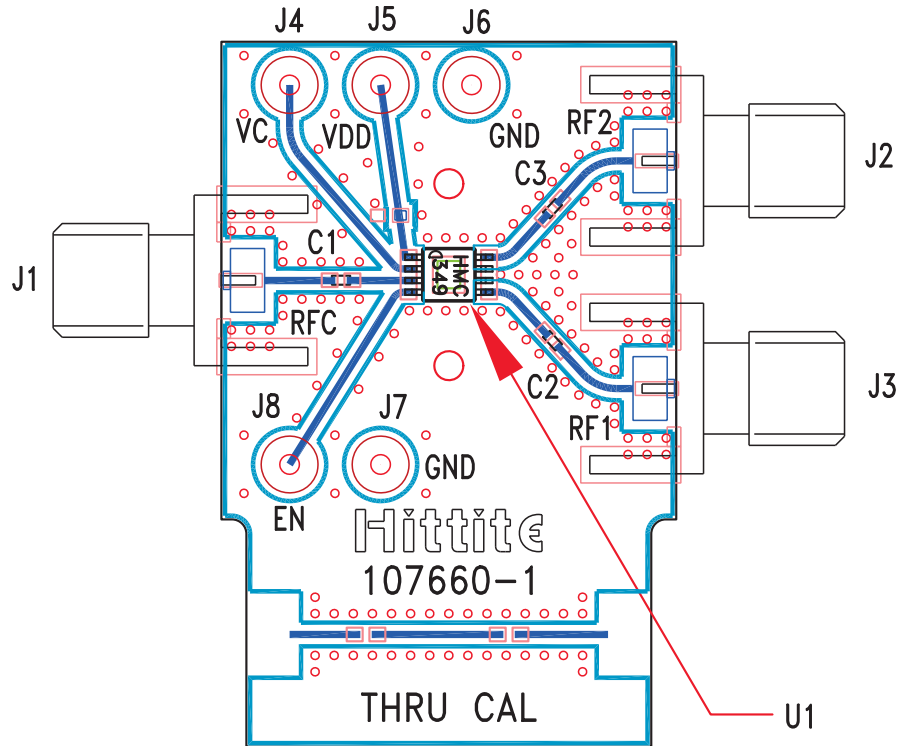

10

SWITCHES - SMT

### List of Materials for Evaluation PCB 107662 [1]

Item	Description
J1 - J3	PCB Mount SMA RF Connector
J4 - J8	DC Pin
C1 - C3	100 pF Capacitor, 0402 Pkg.
U1	HMC349MS8G / HMC349MS8GE SPDT Switch
PCB [2]	107660 Evaluation PCB

[1] Reference this number when ordering complete evaluation PCB

[2] Circuit Board Material: Rogers 4350

The circuit board used in the final application should be generated with proper RF circuit design techniques. Signal lines at the RF port should have 50 ohm impedance and the package ground leads and backside ground slug should be connected directly to the ground plane similar to that shown above. The evaluation circuit board shown above is available from Hittite Microwave Corporation upon request.