

XS930S4PAM12

Inductive proximity sensors XS, inductive sensor XS9 M30, L64mm, full SS 316L, Sn40 mm, 12...24 VDC, M12



Main

Range of Product	Telemecanique Inductive proximity sensors XS
Series name	Application
Sensor Type	Inductive proximity sensor
Device Application	Food and beverage
Market Segment	Pharmaceutical
Sensor name	XS9
Sensor design	Cylindrical M30
Size	64 mm
Body type	Single piece body
Enclosure Material	Stainless steel 316L
Type of output signal	Discrete
Wiring Technique	3-wire
[Sn] nominal sensing distance	1.57 in (40 mm)
Discrete output function	1 NO
Discrete output type	PNP
Electrical connection	Male connector M12, 4 pins
[Us] rated supply voltage	12...24 V DC reverse polarity protection
Switching capacity in mA	<= 200 mA overload and short-circuit protection
IP degree of protection	IP68 conforming to IEC 60529 IP69K

Complementary

Thread type	M30 x 1.5
Detection face	Frontal
Detector flush mounting acceptance	Non flush mountable
Material	Stainless steel 316L
Front material	Stainless steel 316L
Sensing range	> 0.59...1.57 in (> 15...40 mm)
Operating zone	0.00...1.26 in (0...32 mm)
Differential travel	1...15 % of Sr
Repeat accuracy	<= 5 % of Sr
Output circuit type	DC
Status LED	Output state 1 LED yellow)
Supply voltage limits	10...30 V DC
Maximum residual current	0.1 mA open state
Switching frequency	<= 90 Hz
Maximum voltage drop	<2 V closed)
Current consumption	<= 10 mA no-load
Maximum delay first up	40 ms
Maximum delay response	0.00006 ms
Maximum delay recovery	0.015 ms
Marking	CE
Threaded length	1.26 in (32 mm)
Height	1.18 in (30 mm)

Length	2.52 in (64 mm)
Net Weight	0.32 lb(US) (0.145 kg)

Environment

Product Certifications	Ecolab cULus
Ambient Air Temperature for Operation	-13...185 °F (-25...85 °C)
Ambient Air Temperature for Storage	-13...185 °F (-25...85 °C)
Vibration resistance	25 gn +/- 1 mm 10...55 Hz)IEC 60068-2-6
Shock resistance	30 gn 11 msIEC 60068-2-27



Ordering and shipping details

Category	22486-SENSORS, PROXIMITY
Discount Schedule	DS2
GTIN	3389119079198
Nbr. of units in pkg.	1
Package weight(Lbs)	5.22 oz (148.0 g)
Returnability	No
Country of origin	HU

Packing Units

Unit Type of Package 1	PCE
Package 1 Height	1.77 in (4.5 cm)
Package 1 width	2.36 in (6 cm)
Package 1 Length	5.51 in (14 cm)
Unit Type of Package 2	S01
Number of Units in Package 2	25
Package 2 Weight	8.54 lb(US) (3.873 kg)
Package 2 Height	5.91 in (15 cm)
Package 2 width	5.91 in (15 cm)
Package 2 Length	15.75 in (40 cm)

Offer Sustainability

California proposition 65	WARNING: This product can expose you to chemicals including: Diisononyl phthalate (DINP), which is known to the State of California to cause cancer, and Di-isodecyl phthalate (DIDP), which is known to the State of California to cause birth defects or other reproductive harm. For more information go to www.P65Warnings.ca.gov
REACH Regulation	 REACH Declaration
EU RoHS Directive	Pro-active compliance (Product out of EU RoHS legal scope)  EU RoHS Declaration
Mercury free	Yes
RoHS exemption information	 Yes

Contractual warranty

Warranty	18 months
----------	-----------

Dimensions

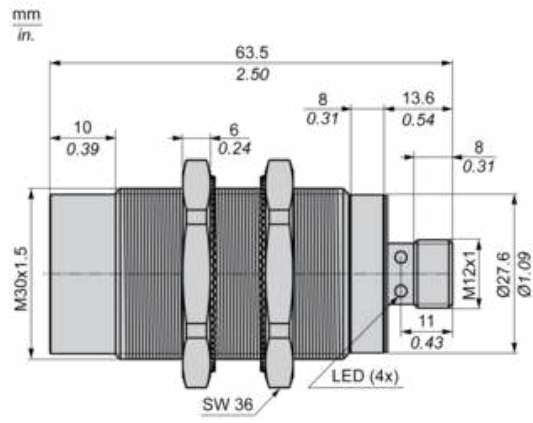

Minimum Mounting Distances in mm

Side by side



$e (1) \geq 270 \text{ mm}/10.63 \text{ in.}$

Face to face

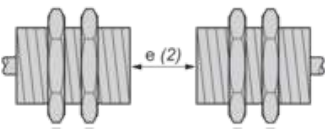

$e (2) \geq 130 \text{ mm}/5.12 \text{ in.}$

Facing a metal object



$e (3) \geq 120 \text{ mm}/4.72 \text{ in.}$

Mounted in a metal support

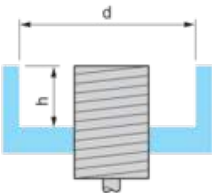

$d \geq 120 \text{ mm}/4.72 \text{ in.}$

$h \geq 34 \text{ mm}/1.34 \text{ in.}$

Wiring Schemes

M12 connector

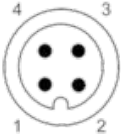

PNP



1 : (+)

2 : Not connected

3 : (-)

4 : NO Output