





SPECIFICATIONS

CUSTOMER : _____
MODEL NO. : **GFT018DH128160**
VERSION : **B**
DATE : **2023.03.02**
CERTIFICATION : **ROHS**

Customer Sign	Approved By	Prepared By	Prepared By
	 GIFAR 2023.03.02 Sidney	 GIFAR 2023.03.02 Roger	 GIFAR 2023.03.02 Hazel

晶發科技股份有限公司
GI FAR TECHNOLOGY CO., LTD.

新北市樹林區東豐街 81 號

No. 81, Dongfeng St, Shulin District, 238034, New Taipei City, Taiwan, R.O.C.

TEL: +886-2-8684-1188 FAX: +886-2-8684-8532



Contents

1. SPECIFICATIONS

- 1.1 Features
- 1.2 Mechanical Specifications
- 1.3 Absolute Maximum Ratings
- 1.4 DC Electrical Characteristics
- 1.5 Optical Characteristics
- 1.6 Backlight Characteristics

2. MODULE STRUCTURE

- 2.1 Block Diagram
- 2.2 Interface Pin Description
- 2.3 Timing Characteristics

3. QUALITY ASSURANCE SYSTEM

- 3.1 Quality Assurance Flow Chart
- 3.2 Inspection Specification

4. RELIABILITY TEST

- 4.1 Reliability Test Condition

5. PRECAUTION RELATING PRODUCT HANDLING

- 5.1 Safety
- 5.2 Handling
- 5.3 Storage
- 5.4 Terms of Warranty

6. LCM Dimension

7. PACKAGE INFORMATION



1. SPECIFICATIONS

1.1 Features

Main LCD Panel

Item	Standard Value
Display Type	128 * (R、G、B) * 160 Dots
LCD Type	a-Si TFT, Normally White, Transmissive
Screen size(inch)	1.77 (Diagonal)
Viewing Direction	12 O'clock
Color configuration	R.G.B. vertical stripe
Backlight	White LED
Interface	8-bit interface for 80 system
Other(controller / driver IC)	ST7735S

1.2 Mechanical Specifications

Item	Standard Value	Unit
Outline Dimension	34.0 (W) * 47.0 (L) * 2.4 (H)(MAX)	mm
Viewing Area (LCD)	29.032 (W) * 36.04 (L)	mm
Active Area (LCD)	28.032 (W) * 35.04 (L)	mm

Note: For detailed information please refer to LCM drawing.



1.3 Absolute Maximum Ratings

Module

Item	Symbol	Condition	Min.	Max.	Unit
System Power Supply Voltage	VDD	-	-0.3	+4.6	V
	VGH-VGL	-	-0.3	30.0	V
Input Voltage	VIN	-	-0.3	VDD+0.3	V
Operating Temperature	TOP	-	-20	+70	°C
Storage Temperature	TST	-	-30	+80	°C
Storage Humidity	HD	Ta ≤ 60 °C	20	90	%RH

1.4 DC Electrical Characteristics

Module

GND = 0V, Ta = 25°C

Item	Symbol	Condition	Min.	Typ.	Max.	Unit
Interface operation voltage	VDD		2.5	2.8	3.7	V
Input High Voltage	VIH	-	0.7*VDD	-	VDD	V
Input Low Voltage	VIL		GND	-	0.3*VDD	V
Output High Voltage	VOH		0.8*VDD	-	VDD	V
Output Low Voltage	VOL		GND	-	0.2*VDD	V
Supply Current	IDD	VDD= 2.8V, Pattern= TBD*1	-	1.4	2.1	mA

Note1 : Maximum current display.



1.5 Optical Characteristics

TFT LCD Panel

VDD = 2.8V, Ta=25°C

Item	Symbol	Condition	Min.	Typ.	Max.	unit		
Response time	Tr + Tf	-	-	28	42	ms	Note2	
Viewing angle	Rear	$\theta+$	-	15	-	Deg.	Note1	
	Front	$\theta-$	-	45	-			
	Left	θL	-	45	-			
	Right	θR	-	45	-			
Contrast ratio	CR	-	200	250	-	-	Note3	
Color of CIE Coordinate (With B/L)	White	X	IF= 30mA	0.24	0.29	0.34	-	Note4
		Y		0.27	0.32	0.37		
	Red	X		0.53	0.58	0.63		
		Y		0.29	0.34	0.39		
	Green	X		0.29	0.34	0.39		
		Y		0.56	0.61	0.66		
	Blue	X		0.10	0.15	0.20		
		Y		0.02	0.07	0.12		
Average Brightness Pattern=white display (With B/L)	IV	IF= 30mA	170	260	-	-	Note4	
Uniformity (With LCD)	ΔB	IF=30mA	80	-	-	%	Note4	

Note4:

1 : $\Delta B = B(\min) / B(\max) \times 100\%$.

2 : Measurement Condition for Optical Characteristics:

a : Environment: $25^{\circ}\text{C} \pm 5^{\circ}\text{C}$ / $60 \pm 20\%$ R.H, no wind, dark room below 10 Lux at typical lamp current and typical operating frequency.

b : Measurement Distance: 500 ± 50 mm, ($\theta = 0^{\circ}$).

c : Equipment: TOPCON BM-7 fast, (field 1°), after 10 minutes operation.

d : The uncertainty of the C.I.E coordinate measurement ± 0.01 , Average Brightness $\pm 4\%$.

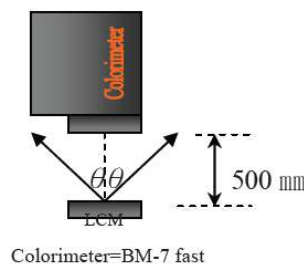



Note1:

Optical characteristics-2

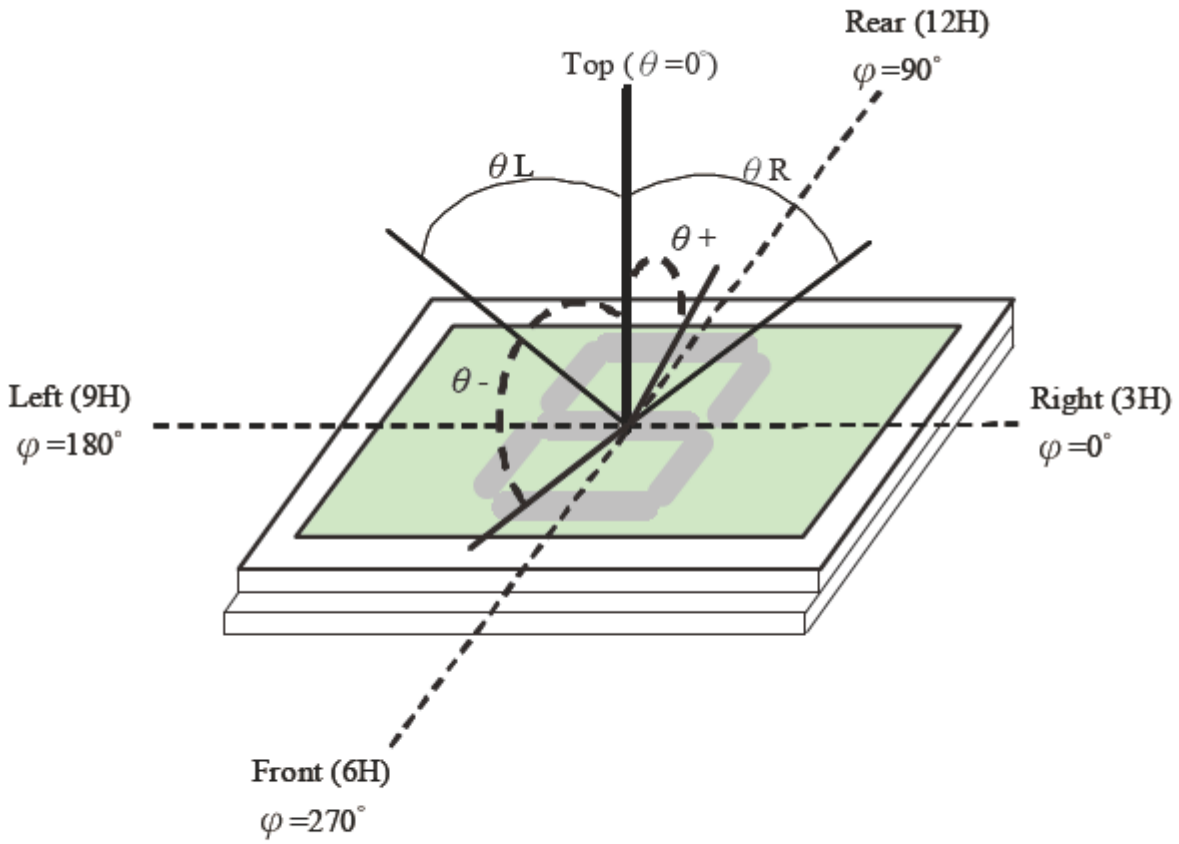

Viewing angle

FORN



Note2:

Optical characteristics-3

Fig.2 Definition of response time

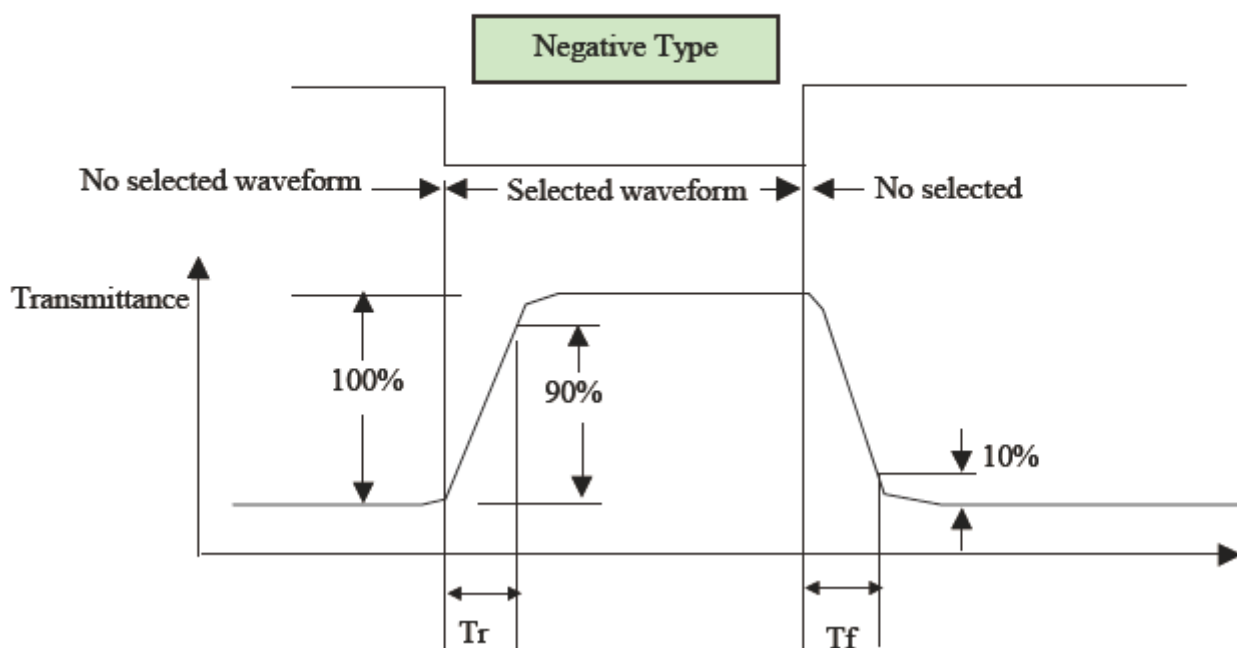
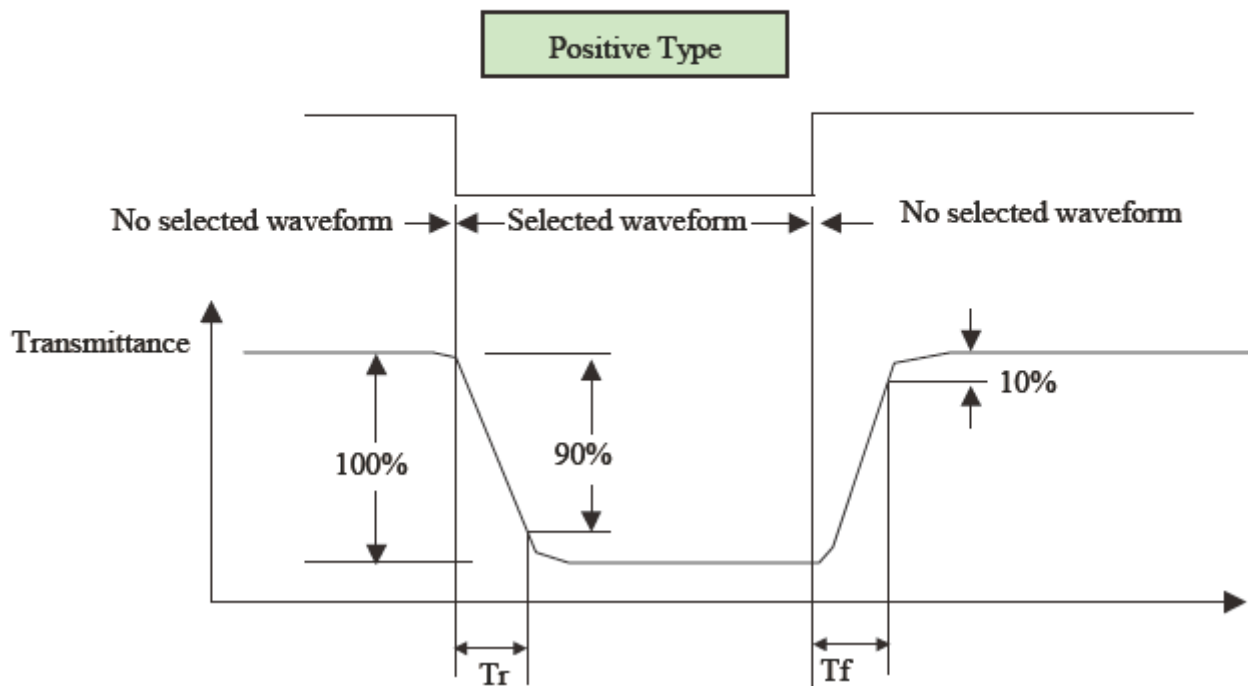



Electrical characteristics-2

※2 Drive waveform

V_{op} : Drive voltage f_F : Frame frequency
 $1/B$: Bias f_D : Drive frequency
 N : Duty

(1) Selected waveform

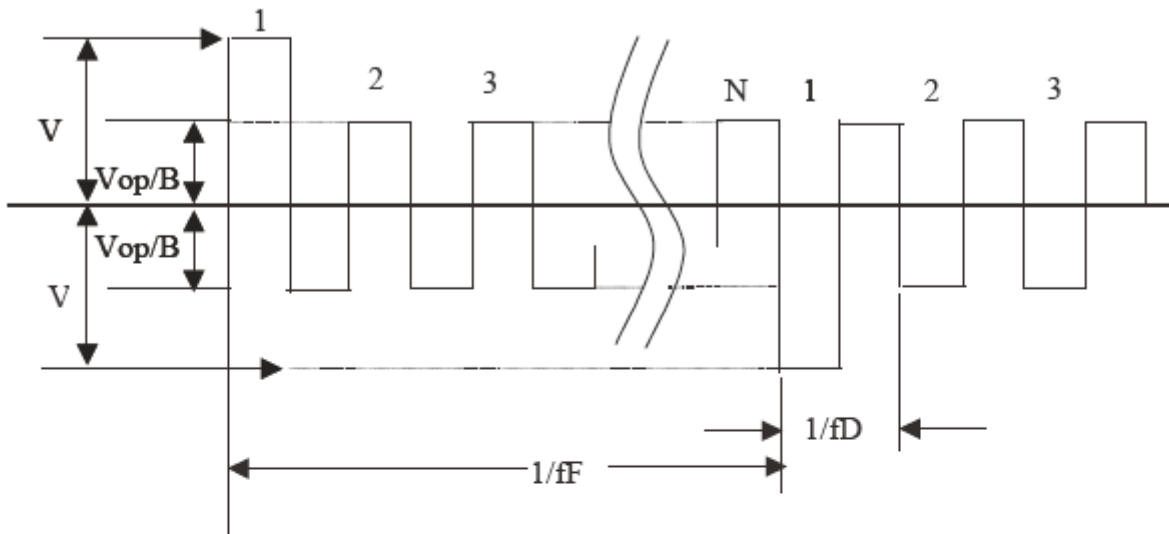

(2) Non- Selected wave form

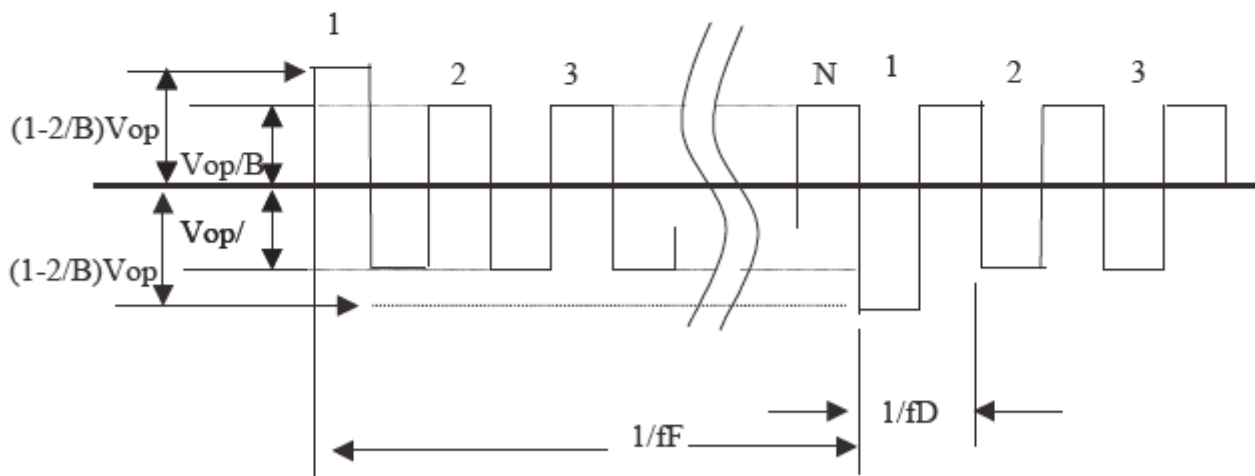

Note:

Frame frequency is defined as follows: Common side supply voltage peak - to - peak / 2 = 1 period



Note 3. : Definition of Vth

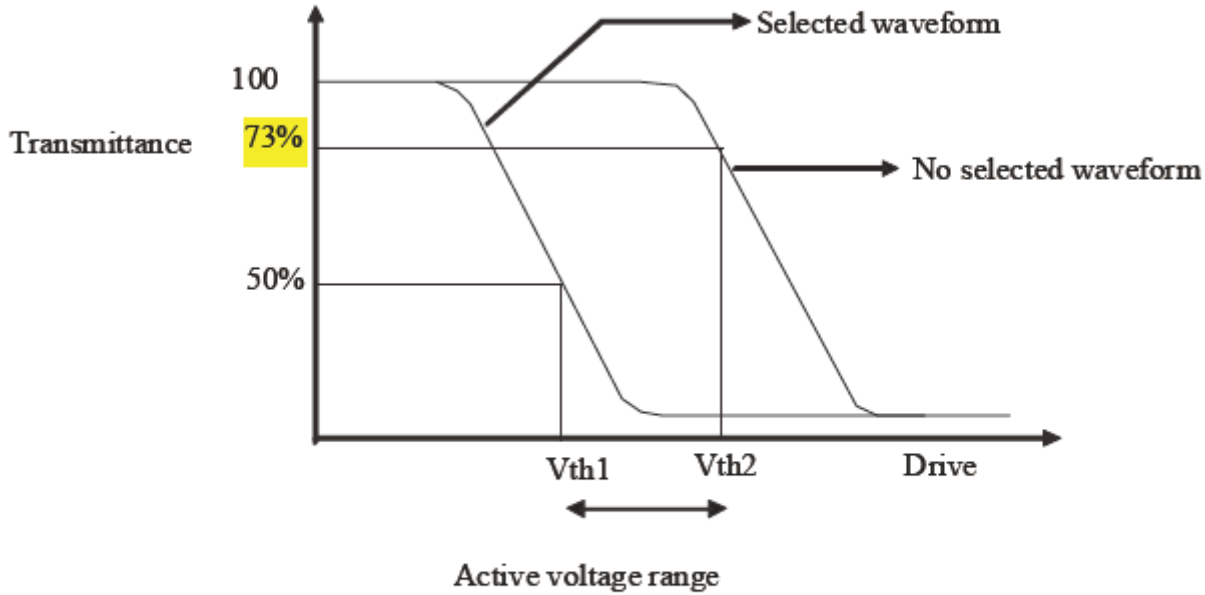

	Vth1	Vth2
View direction	10°	40°
Drive waveform	(Selected waveform)	(No selected waveform)
Transmittance	50%	73%

※1 Contrast ratio
= (Brightness in OFF state) / (Brightness in ON state)

Outline of Electro-Optical Characteristics Measuring System

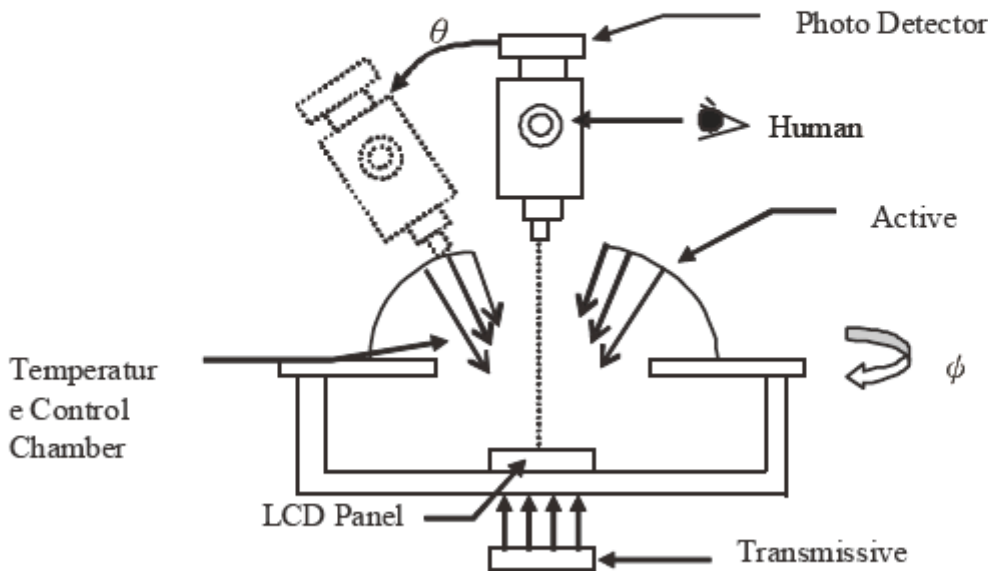

Measuring System: Autronic DMS-803



1.6 Backlight Characteristics

Maximum Ratings

Item	Symbol	Conditions	Min.	Max.	Unit
Forward Current	IF	Ta =25°C	-	60	mA
Reverse Voltage	VR	Ta =25°C	-	5.0	V
Power Dissipation	PD	Ta =25°C	-	180	mW

Electrical / Optical Characteristics

Item	Symbol	Conditions	Min.	Typ.	Max.	Unit
Forward Voltage	VF	IF=30mA	-	3.3	3.5	V
Average Brightness (without LCD)	IV	IF=30mA	3200	3500	-	cd/m2
Color of CIE Coordinate (without LCD)	X		0.25	0.28	0.31	-
	Y	0.25	0.28	0.31		
Color	White					

Circuit Diagram:

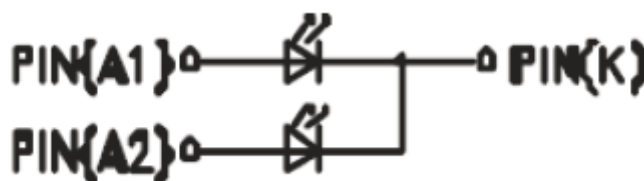

Other Description

Item	Conditions	Description
Life Time	Ta =25°C IF= 30 mA	30000 hrs



2. MODULE STRUCTURE

2.1 Block Diagram

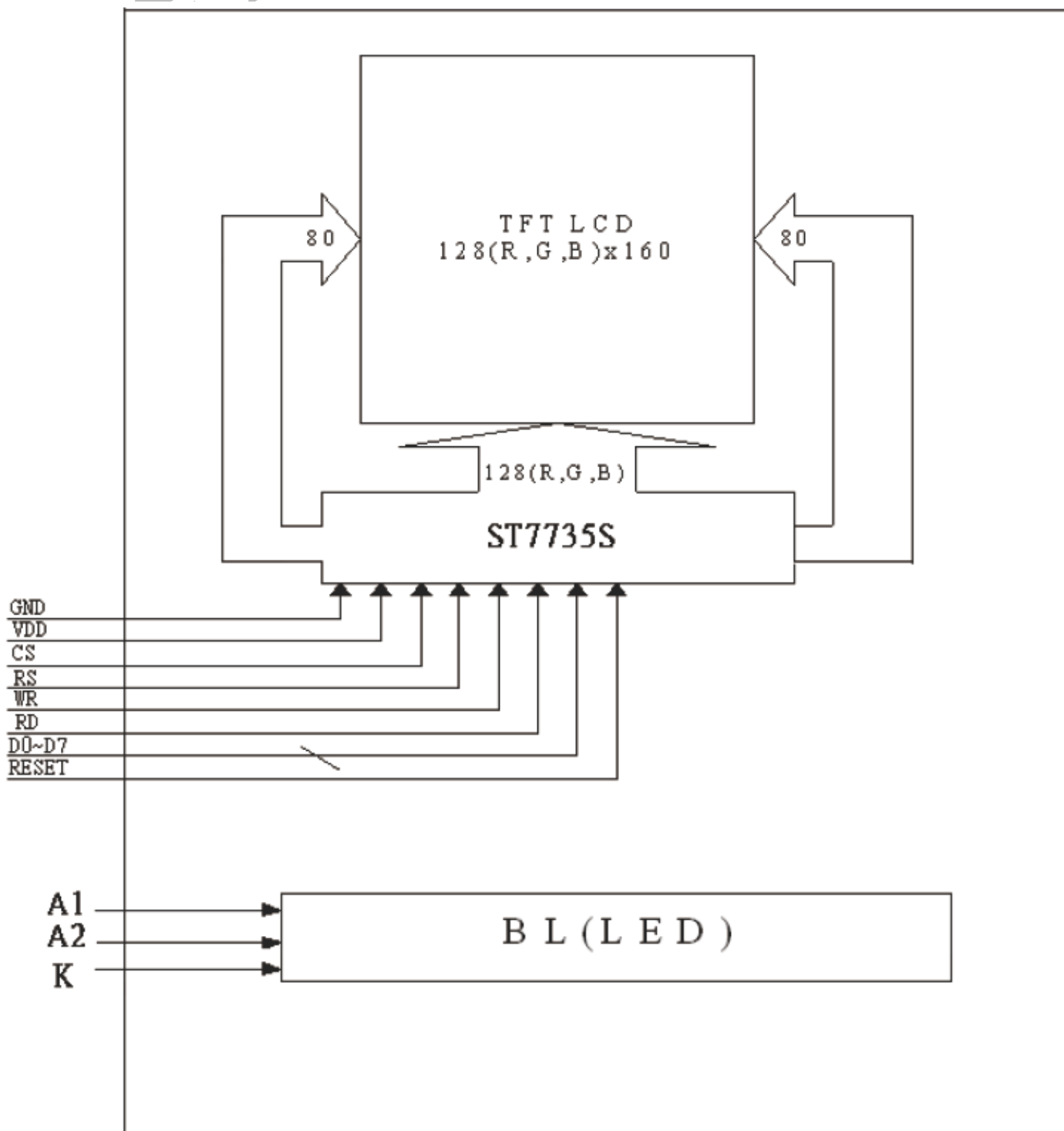



2.2 Interface Pin Description

Pin No.	Symbol	Function
1	GND	System ground
2	GND	System ground
3	VDD	Power supply for analog, digital , I/O system and booster circuit
4	VDD	Power supply for analog, digital , I/O system and booster circuit
5	CS	Chip selection pin, Active "L".
6	RS	The signal for command or parameter select under parallel mode Low: command. ; High: parameter.
7	WR	Write enable in MPU parallel interface, Active "L".
8	RD	Read signal input , Active "L".
9	D0	Bi-directional data bus.
10	D1	
11	D2	
12	D3	
13	D4	
14	D5	
15	D6	
16	D7	
17	RESET	This signal will reset the device and it must be applied to properly initialize the chip, Active "L".
18	GND	System ground
19	LED1+	Power Supply for LED Backlight Anode input.
20	LED2+	Power Supply for LED Backlight Anode input.
21	LED-	Power Supply for LED Backlight Cathode input.



2.2.1 Refer Initial code:

```

void LCD_Init(void)
{
    lcddev.width=128;
    lcddev.height=160;
    LCD_WR_REG(0x0001);           //Software Reset

    delay_ms(120);               //Delay 120ms

    LCD_WR_REG(0x0011);         //Sleep out

    delay_ms(120);               //Delay 120ms

    LCD_WR_REG(0x0026);         //GAMMA Set
    LCD_WR_DATA(0x0008);
    LCD_WR_REG(0x00e0);         //Gamma adjustment (+ polarity)
    LCD_WR_DATA(0x003f);
    LCD_WR_DATA(0x001a);
    LCD_WR_DATA(0x000f);
    LCD_WR_DATA(0x0018);
    LCD_WR_DATA(0x002f);
    LCD_WR_DATA(0x0028);
    LCD_WR_DATA(0x0020);
    LCD_WR_DATA(0x0022);
    LCD_WR_DATA(0x001f);
    LCD_WR_DATA(0x001b);
    LCD_WR_DATA(0x0023);
    LCD_WR_DATA(0x0037);
    LCD_WR_DATA(0x0000);
    LCD_WR_DATA(0x0007);
    LCD_WR_DATA(0x0002);
    LCD_WR_DATA(0x0010);
    LCD_WR_REG(0x00e1);         //Gamma adjustment (- polarity)
    LCD_WR_DATA(0x000f);
    LCD_WR_DATA(0x001b);
    LCD_WR_DATA(0x000f);
    LCD_WR_DATA(0x0017);
    LCD_WR_DATA(0x0033);
    LCD_WR_DATA(0x002c);
    LCD_WR_DATA(0x0029);
    LCD_WR_DATA(0x002e);
    LCD_WR_DATA(0x0030);
    LCD_WR_DATA(0x0030);
    LCD_WR_DATA(0x0039);
    LCD_WR_DATA(0x003f);
    LCD_WR_DATA(0x0000);
    LCD_WR_DATA(0x0007);
    LCD_WR_DATA(0x0003);
    LCD_WR_DATA(0x0010);

```



```
LCD_WR_REG(0x0020); //Inverion OFF
LCD_WR_REG(0x0036); //Memory data access control
LCD_WR_DATA(0x00c0); //MY MX MV ML RGB MH - -
LCD_WR_REG(0x003a); //Interface Pixel Format
LCD_WR_DATA(0x0005); //16-bit/pixel
LCD_WR_REG(0x00B1); //Frame Rate In normal mode
LCD_WR_DATA(0x0009); //RTNA set 1-line period
LCD_WR_DATA(0x0029); //FPA: front porch
LCD_WR_DATA(0x0029); //BPA: back porch
LCD_WR_REG(0x00C0); //Power control setting
LCD_WR_DATA(0x00a0|0x0002); //AVDD=5V; VRHP: Set the GVDD voltage
LCD_WR_DATA(0x0002); //VRHN: Set the GVCL voltage
LCD_WR_DATA(0x0004);
LCD_WR_REG(0x00c1); //Power control setting
LCD_WR_DATA(0x00c5); //BT: set VGH=AVDD*3=15V / VGL=-10V voltage
LCD_WR_REG(0x00c2); //In normal mode (Full colors)
LCD_WR_DATA(0x000a); //APA: adjust the operational amplifier
LCD_WR_DATA(0x0000); //DCA: adjust the booster Voltage
LCD_WR_REG(0x00C5); //VCOM
LCD_WR_DATA(0x0026); //-1.375V
LCD_WR_REG(0x00C7); //VCOM Pffset
LCD_WR_DATA(0x0010); //0V
LCD_WR_REG(0x0029); //Display on
}
```

WORLDWIDE
FOOTPRINT



2.3 Timing Characteristics

80-System Bus Interface

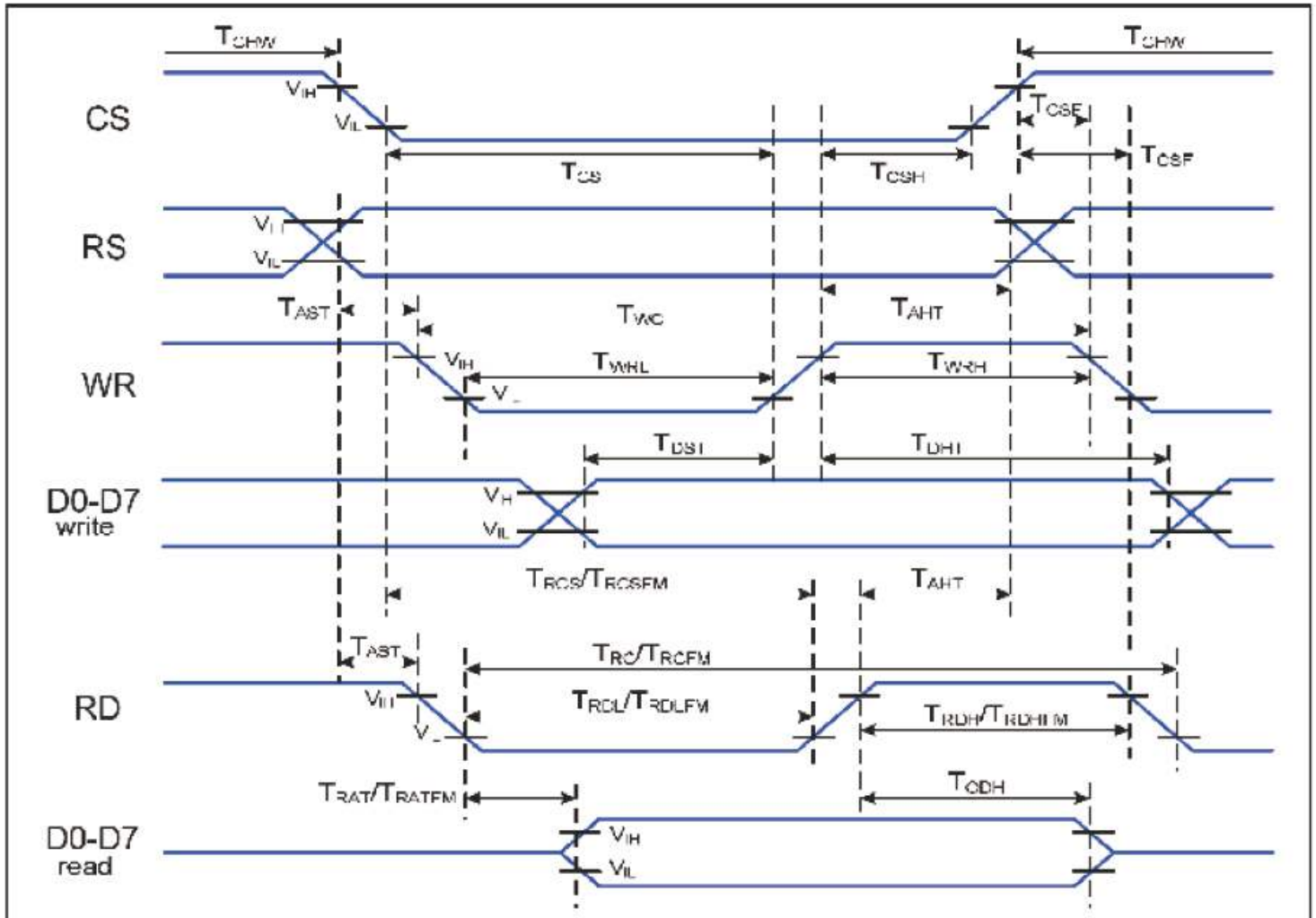

FOOTPRINT



Signal	Symbol	Parameter	Min	Max	Unit	Description
RS	TAST	Address setup time	10		ns	-
	TAHT	Address hold time (Write/Read)	10		ns	
CS	TCHW	Chip select "H" pulse width	0		ns	-
	TCS	Chip select setup time (Write)	15		ns	
	TRCS	Chip select setup time (Read ID)	45		ns	
	TRCSFM	Chip select setup time (Read FM)	350		ns	
	TCSF	Chip select wait time (Write/Read)	10		ns	
	TCSH	Chip select hold time	10		ns	
WR	TWC	Write cycle	100		ns	
	TWRH	Control pulse "H" duration	30		ns	
	TWRL	Control pulse "L" duration	30		ns	
RD (ID)	TRC	Read cycle (ID)	160		ns	When read ID data
	TRDH	Control pulse "H" duration (ID)	90		ns	
	TRDL	Control pulse "L" duration (ID)	45		ns	
RD (FM)	TRCFM	Read cycle (FM)	450		ns	When read from frame memory
	TRDHFM	Control pulse "H" duration (FM)	150		ns	
	TRDLFM	Control pulse "L" duration (FM)	150		ns	
D0-D7	TDST	Data setup time	10		ns	For CL=30pF
	TDHT	Data hold time	10		ns	
	TRAT	Read access time (ID)		40	ns	
	TRATFM	Read access time (FM)		40	ns	
	TODH	Output disable time		80	ns	

Reset Timing:

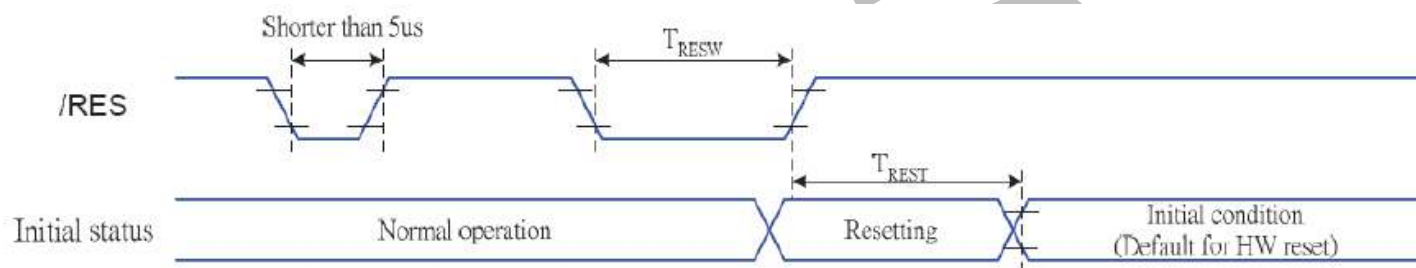

Related Pins	Symbol	Parameter	MIN	MAX	Unit
RESET	tRESW	Reset pulse duration	10	-	us
	tREST	Reset cancel	-	5 120	ms



3. QUALITY ASSURANCE SYSTEM

3.1 Quality Assurance Flow Chart

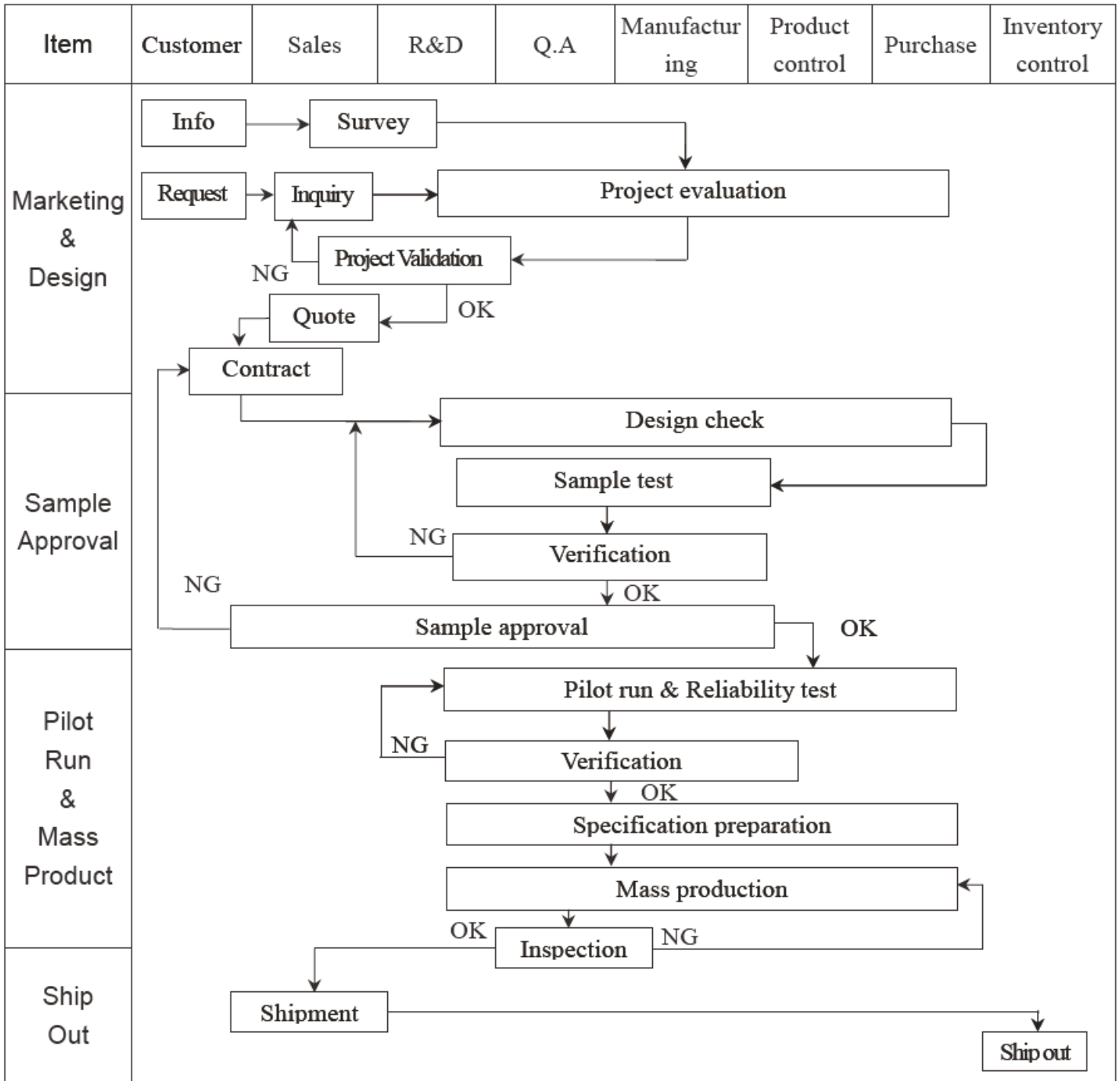



Item	Customer	Sales	R&D	Q.A	Manufacturing	Product control	Purchase	Inventory control
Sales Service	<pre> graph TD Info[Info] --> Claim[Claim] Claim --> FA[Failure analysis] Claim --> AR[Analysis report] FA --> CA[Corrective action] CA --> Tracking[Tracking] </pre>							
Q.A Activity	1. ISO 9001 Maintenance Activities 3. Equipment calibration 5. Standardization Management				2. Process improvement proposal 4. Education And Training Activities			

COPYRIGHT



3.2. Inspection Specification

- ◆ Scope : The document shall be applied to TFT-LCD Module for less than 3.5" (Ver:B01).
- ◆ Inspection Standard : MIL-STD-105E Table Normal Inspection Single Sampling Level II .
- ◆ Equipment : Gauge 、 MIL-STD 、 Sample
- ◆ Defect Level : Major Defect AQL : 0.4 ; Minor Defect AQL : 1.5
- ◆ OUT Going Defect Level : Sampling.
- ◆ Standard of the product appearance test :

a. Manner of appearance test :

- (1). The test best be under 20W×2 fluorescent light , and distance of view must be at 30 cm.
- (2). The test direction is base on about around 45° of vertical line.

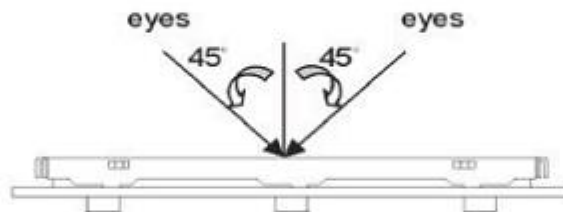

(3). Definition of area.

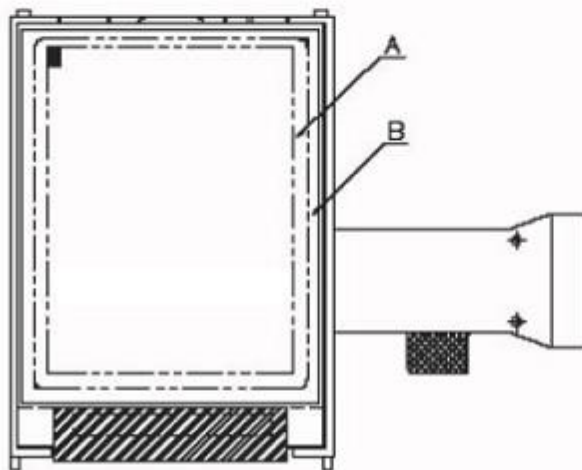

A area : viewing area

B area : Outside of viewing area

(4). Standard of inspection : (Unit : mm)



◆ Specification For TFT-LCD Module Less Than 3.5" :

(Ver.B01)

NO	Item	Criterion	Level												
01	Product condition	1. 1 The part number is inconsistent with work order of production.	Major												
		1. 2 Mixed product types.	Major												
		1. 3 Assembled in inverse direction.	Major												
02	Quantity	2. 1 The quantity is inconsistent with work order of production.	Major												
03	Outline dimension	3. 1 Product dimension and structure must conform to structure diagram.	Major												
04	Electrical Testing	4. 1 Missing line character and icon.	Major												
		4. 2 No function or no display.	Major												
		4. 3 Display malfunction.	Major												
		4. 4 LCD viewing angle defect.	Major												
		4. 5 Current consumption exceeds product specifications.	Major												
05	Dot defect (Bright dot 、 Dark dot) On -display	<table border="1"> <thead> <tr> <th></th> <th>Item</th> <th>Acceptance (Q'ty)</th> </tr> </thead> <tbody> <tr> <td rowspan="4">Dot Defect</td> <td>Bright Dot</td> <td>≤ 2</td> </tr> <tr> <td>Dark Dot</td> <td>≤ 3</td> </tr> <tr> <td>Joint Dot</td> <td>≤ 2</td> </tr> <tr> <td>Total</td> <td>≤ 3</td> </tr> </tbody> </table>		Item	Acceptance (Q'ty)	Dot Defect	Bright Dot	≤ 2	Dark Dot	≤ 3	Joint Dot	≤ 2	Total	≤ 3	Minor
			Item	Acceptance (Q'ty)											
		Dot Defect	Bright Dot	≤ 2											
			Dark Dot	≤ 3											
			Joint Dot	≤ 2											
Total	≤ 3														
5. 1 Inspection pattern : full white , full black , Red , Green and blue screens.															
5. 2 It is defined as dot defect if defect area > 1/2 dot.															
5. 3 The distance between two dot defect ≥ 5 mm.															

SECRET



◆Specification For TFT-LCD Module Less Than 3.5" :

(Ver.B01)

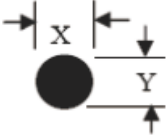
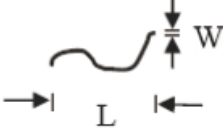
NO	Item	Criterion	Level																																										
06	<p>Black or white dot、scratch、contamination</p> <p>Round type</p>  <p>$\Phi = (x + y) / 2$</p> <p>Line type</p> 	<p>6.1 Round type (Non-display or display) :</p> <table border="1" data-bbox="539 427 1337 891"> <thead> <tr> <th rowspan="2">Dimension (diameter : Φ)</th> <th colspan="2">Acceptance (Q'ty)</th> </tr> <tr> <th>A area</th> <th>B area</th> </tr> </thead> <tbody> <tr> <td>$\Phi \leq 0.15$</td> <td colspan="2">Ignore</td> </tr> <tr> <td>$0.15 < \Phi \leq 0.20$</td> <td colspan="2">2</td> </tr> <tr> <td>$0.20 < \Phi \leq 0.30$</td> <td colspan="2">2</td> </tr> <tr> <td>$\Phi > 0.30$</td> <td colspan="2">0</td> </tr> <tr> <td>Total</td> <td colspan="2">3</td> </tr> </tbody> </table> <p>6.2 Line type(Non-display or display) :</p> <table border="1" data-bbox="520 1010 1353 1435"> <thead> <tr> <th colspan="2">Dimension</th> <th colspan="2">Acceptance (Q'ty)</th> </tr> <tr> <th>Length (L)</th> <th>Width (W)</th> <th>A area</th> <th>B area</th> </tr> </thead> <tbody> <tr> <td>---</td> <td>$W \leq 0.03$</td> <td>Ignore</td> <td rowspan="3">Ignore</td> </tr> <tr> <td>$L \leq 5.0$</td> <td>$0.03 < W \leq 0.05$</td> <td>3</td> </tr> <tr> <td>---</td> <td>$W > 0.05$</td> <td>As round type</td> </tr> <tr> <td colspan="2">Total</td> <td colspan="2">3</td> </tr> </tbody> </table>	Dimension (diameter : Φ)	Acceptance (Q'ty)		A area	B area	$\Phi \leq 0.15$	Ignore		$0.15 < \Phi \leq 0.20$	2		$0.20 < \Phi \leq 0.30$	2		$\Phi > 0.30$	0		Total	3		Dimension		Acceptance (Q'ty)		Length (L)	Width (W)	A area	B area	---	$W \leq 0.03$	Ignore	Ignore	$L \leq 5.0$	$0.03 < W \leq 0.05$	3	---	$W > 0.05$	As round type	Total		3		Minor
Dimension (diameter : Φ)	Acceptance (Q'ty)																																												
	A area	B area																																											
$\Phi \leq 0.15$	Ignore																																												
$0.15 < \Phi \leq 0.20$	2																																												
$0.20 < \Phi \leq 0.30$	2																																												
$\Phi > 0.30$	0																																												
Total	3																																												
Dimension		Acceptance (Q'ty)																																											
Length (L)	Width (W)	A area	B area																																										
---	$W \leq 0.03$	Ignore	Ignore																																										
$L \leq 5.0$	$0.03 < W \leq 0.05$	3																																											
---	$W > 0.05$	As round type																																											
Total		3																																											
07	Polarizer Bubble	<table border="1" data-bbox="528 1487 1347 1906"> <thead> <tr> <th rowspan="2">Dimension (diameter : Φ)</th> <th colspan="2">Acceptance (Q'ty)</th> </tr> <tr> <th>A area</th> <th>B area</th> </tr> </thead> <tbody> <tr> <td>$\Phi \leq 0.20$</td> <td colspan="2">Ignore</td> </tr> <tr> <td>$0.20 < \Phi \leq 0.50$</td> <td colspan="2">3</td> </tr> <tr> <td>$\Phi > 0.50$</td> <td colspan="2">0</td> </tr> <tr> <td>Total</td> <td colspan="2">3</td> </tr> </tbody> </table>	Dimension (diameter : Φ)	Acceptance (Q'ty)		A area	B area	$\Phi \leq 0.20$	Ignore		$0.20 < \Phi \leq 0.50$	3		$\Phi > 0.50$	0		Total	3		Minor																									
Dimension (diameter : Φ)	Acceptance (Q'ty)																																												
	A area	B area																																											
$\Phi \leq 0.20$	Ignore																																												
$0.20 < \Phi \leq 0.50$	3																																												
$\Phi > 0.50$	0																																												
Total	3																																												



◆Specification For TFT-LCD Module Less Than 3.5" :

(Ver.B01)

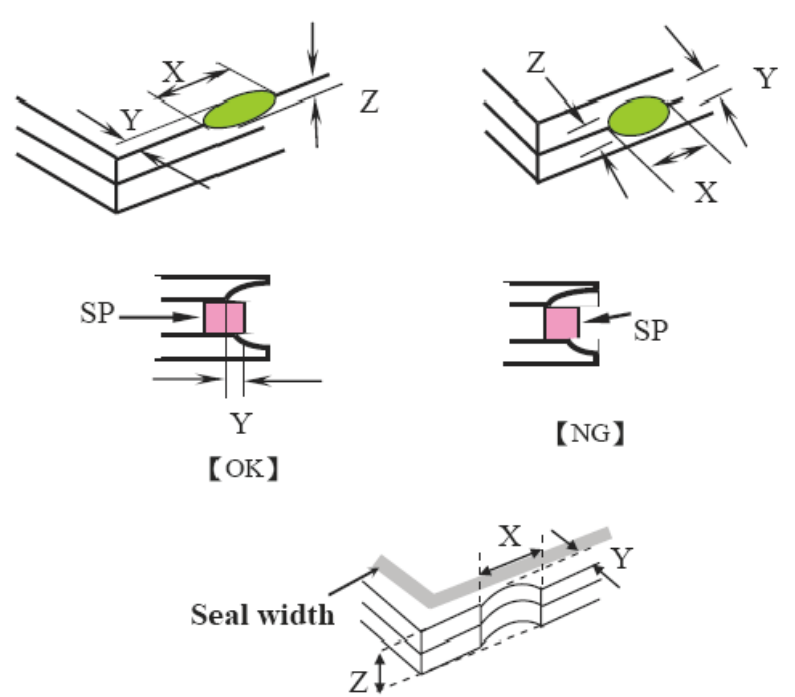
NO	Item	Criterion	Level									
08	The crack of glass	<p>Symbols :</p> <p>X : The length of crack Z : The thickness of crack t : The thickness of glass</p> <p>Y : The width of crack. W : terminal length a : LCD side length</p> <hr/> <p>8.1 General glass chip :</p> <p>8.1.1 Chip on panel surface and crack between panels:</p>  <table border="1" data-bbox="534 1467 1356 1769"> <thead> <tr> <th>X</th> <th>Y</th> <th>Z</th> </tr> </thead> <tbody> <tr> <td>$\leq a$</td> <td>Crack can't enter viewing area</td> <td>$\leq 1/2 t$</td> </tr> <tr> <td>$\leq a$</td> <td>Crack can't exceed the half of SP width.</td> <td>$1/2 t < Z \leq 2 t$</td> </tr> </tbody> </table>	X	Y	Z	$\leq a$	Crack can't enter viewing area	$\leq 1/2 t$	$\leq a$	Crack can't exceed the half of SP width.	$1/2 t < Z \leq 2 t$	Minor
X	Y	Z										
$\leq a$	Crack can't enter viewing area	$\leq 1/2 t$										
$\leq a$	Crack can't exceed the half of SP width.	$1/2 t < Z \leq 2 t$										





◆ Specification For TFT-LCD Module Less Than 3.5" :

(Ver.B01)

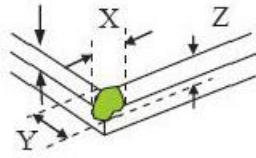
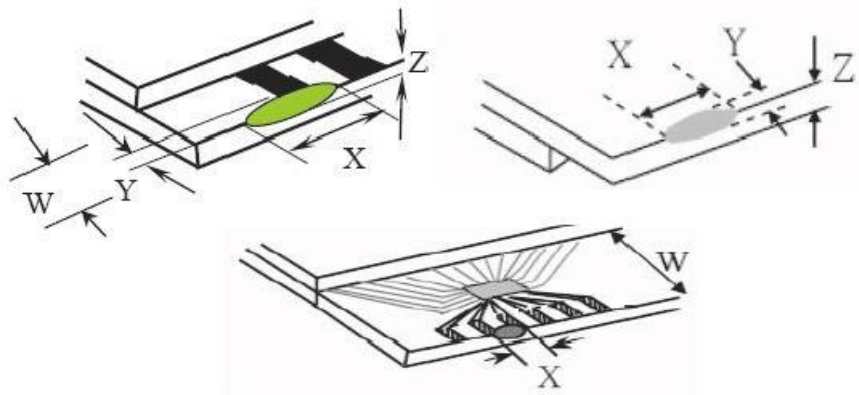
NO	Item	Criterion	Level										
08	The crack of glass	<p>Symbols :</p> <p>X : The length of crack Z : The thickness of crack t : The thickness of glass</p> <p>Y : The width of crack. W : terminal length a : LCD side length</p> <hr/> <p>8.1.2 Corner crack :</p>  <table border="1" data-bbox="518 784 1348 1086"> <thead> <tr> <th>X</th> <th>Y</th> <th>Z</th> </tr> </thead> <tbody> <tr> <td>$\leq 1/5 a$</td> <td>Crack can't enter viewing area</td> <td>$Z \leq 1/2 t$</td> </tr> <tr> <td>$\leq 1/5 a$</td> <td>Crack can't exceed the half of SP width.</td> <td>$1/2 t < Z \leq 2 t$</td> </tr> </tbody> </table>	X	Y	Z	$\leq 1/5 a$	Crack can't enter viewing area	$Z \leq 1/2 t$	$\leq 1/5 a$	Crack can't exceed the half of SP width.	$1/2 t < Z \leq 2 t$	Minor	
		X	Y	Z									
$\leq 1/5 a$	Crack can't enter viewing area	$Z \leq 1/2 t$											
$\leq 1/5 a$	Crack can't exceed the half of SP width.	$1/2 t < Z \leq 2 t$											
<p>8.2 Protrusion over terminal :</p> <p>8.2.1 Chip on electrode pad :</p>  <table border="1" data-bbox="558 1691 1356 1870"> <thead> <tr> <th></th> <th>X</th> <th>Y</th> <th>Z</th> </tr> </thead> <tbody> <tr> <td>Front</td> <td>$\leq a$</td> <td>$\leq 1/2 W$</td> <td>$\leq t$</td> </tr> <tr> <td>Back</td> <td>$\leq a$</td> <td>$\leq W$</td> <td>$\leq 1/2 t$</td> </tr> </tbody> </table>		X	Y	Z	Front	$\leq a$	$\leq 1/2 W$	$\leq t$	Back	$\leq a$	$\leq W$	$\leq 1/2 t$	
	X	Y	Z										
Front	$\leq a$	$\leq 1/2 W$	$\leq t$										
Back	$\leq a$	$\leq W$	$\leq 1/2 t$										



◆Specification For TFT-LCD Module Less Than 3.5" :

(Ver.B01)

NO	Item	Criterion	Level
09	Backlight elements	9. 1 Backlight can't work normally.	Major
		9. 2 Backlight doesn't light or color is wrong.	Major
		9. 3 Illumination source flickers when lit.	Major
10	General appearance	10. 1 Pin type 、 quantity 、 dimension must match type in structure diagram.	Major
		10. 2 No short circuits in components on PCB or FPC .	Major
		10. 3 Parts on PCB or FPC must be the same as on the production characteristic chart .There should be no wrong parts , missing parts or excess parts.	Major
		10. 4 Product packaging must the same as specified on packaging specification sheet.	Minor
		10. 5 The folding and peeled off in polarizer are not acceptable.	Minor
		10. 6 The PCB or FPC between B/L assembled distance(PCB or FPC) is ≤ 1.5 mm.	Minor

FOOT



5. PRECAUTION RELATING PRODUCT HANDLING

5.1 SAFETY

5.1.1 If the LCD panel breaks , be careful not to get the liquid crystal to touch your skin.

5.1.2 If the liquid crystal touches your skin or clothes , please wash it off immediately by using soap and water.

5.2 HANDLING

5.2.1 Avoid any strong mechanical shock which can break the glass.

5.2.2 Avoid static electricity which can damage the CMOS LSI—When working with the module , be sure to ground your body and any electrical equipment you may be using.

5.2.3 Do not remove the panel or frame from the module.

5.2.4 The polarizing plate of the display is very fragile. So , please handle it very carefully, do not touch , push or rub the exposed polarizing with anything harder than an HB pencil lead (glass , tweezers , etc.)

5.2.5 Do not wipe the polarizing plate with a dry cloth , as it may easily scratch the surface of plate.

5.2.6 Do not touch the display area with bare hands , this will stain the display area.

5.2.7 Do not use ketonics solvent & aromatic solvent. Use with a soft cloth soaked with a cleaning naphtha solvent.

5.2.8 To control temperature and time of soldering is $320 \pm 10^{\circ}\text{C}$ and 3-5 sec.

5.2.9 To avoid liquid (include organic solvent) stained on LCM

5.3 STORAGE

5.3.1 Store the panel or module in a dark place where the temperature is $25^{\circ}\text{C} \pm 5^{\circ}\text{C}$ and the humidity is below 65% RH.

5.3.2 Do not place the module near organics solvents or corrosive gases.

5.3.3 Do not crush , shake , or jolt the module.

5.4 TERMS OF WARRANTY

5.4.1 Applicable warrant period

The period is within twelve months since the date of shipping out under normal using and storage conditions.

5.4.2 Unaccepted responsibility

This product has been manufactured to your company's specification as a part for use in your company's general electronic products. It is guaranteed to perform according to delivery specifications. For any other use apart from general electronic equipment, we cannot take responsibility if the product is used in nuclear power control equipment, aerospace equipment , fire and security systems or any other applications in which there is a direct risk to human life and where extremely high levels of reliability are required.



6. LCM Dimension

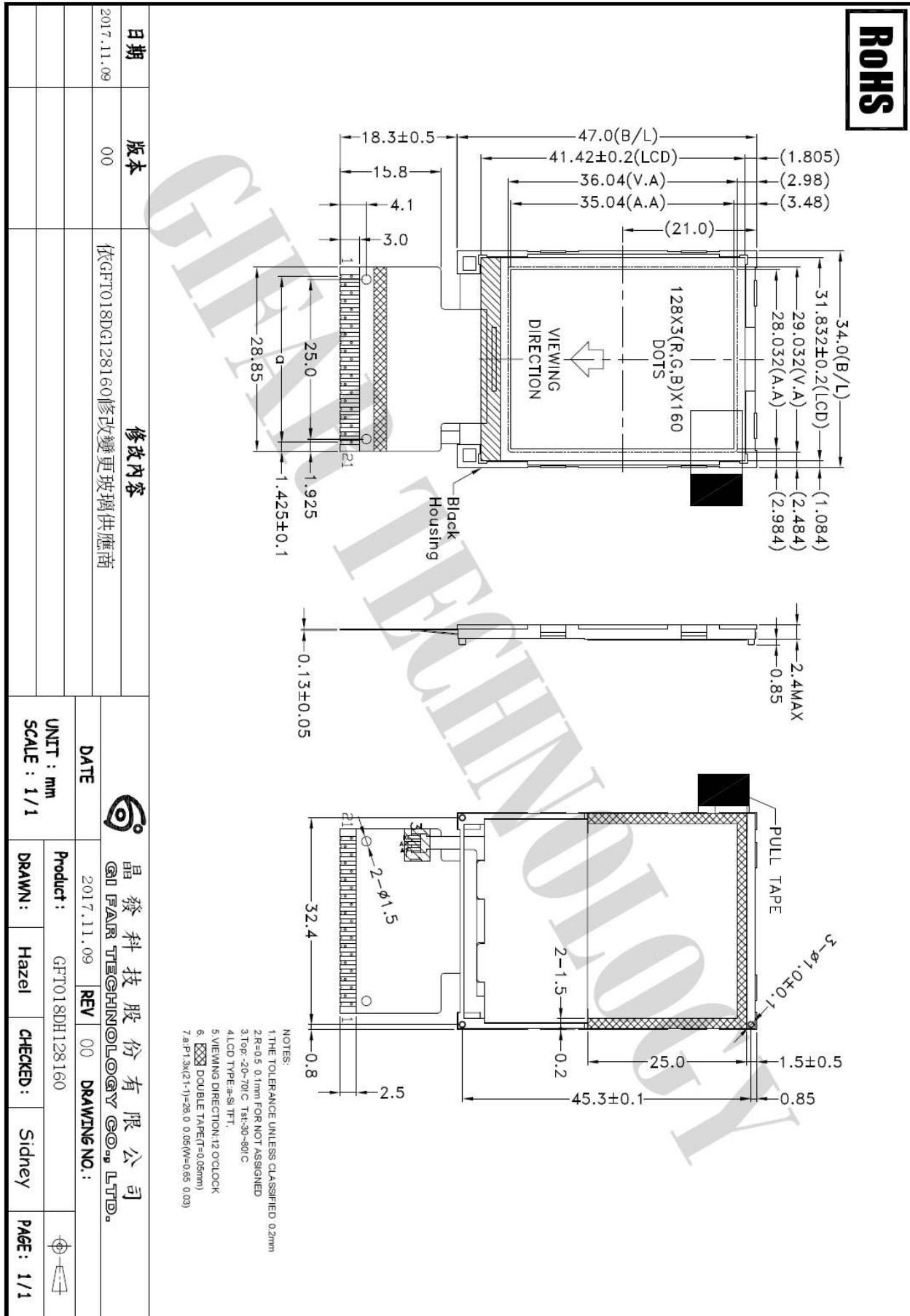



7. PACKAGE INFORMATION

1	1 Tray	:	16 pcs (modules)
2	1 stack	:	9 tray +1 Cover tray
3	1 Carton	:	(1 Cover tray + 9 tray)x 4 stack
4	Total pcs	:	1 Carton (16pcs*9tray * 4 stack) = 576 pcs
5	Carton size	:	395*280*370mm
7	Net weight	:	2.88 KG
8	Gross weight	:	7.7 KG

** 包裝示意圖片

- 一個 tray 盤 可放 16PCS 模組

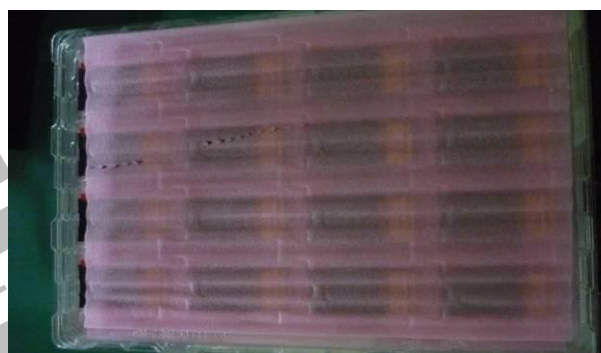

- 9 盤+1 空盤=1 疊，一箱可放入 4 疊



- 紙箱=395*280*370mm，並使用防震材將旁邊空隙填滿

