



AMP | Power Quadlock

TE Internal #: 968073-2

Automotive Terminals, Receptacle, Mating Tab Width 5.2 mm [.205 in], Tab Thickness .63 mm [.025 in], 12 – 11 AWG Wire Size, Power Quadlock

[View on TE.com >](#)

Terminals & Splices > Automotive Terminals > MQS, RECEPTACLE AND TAB

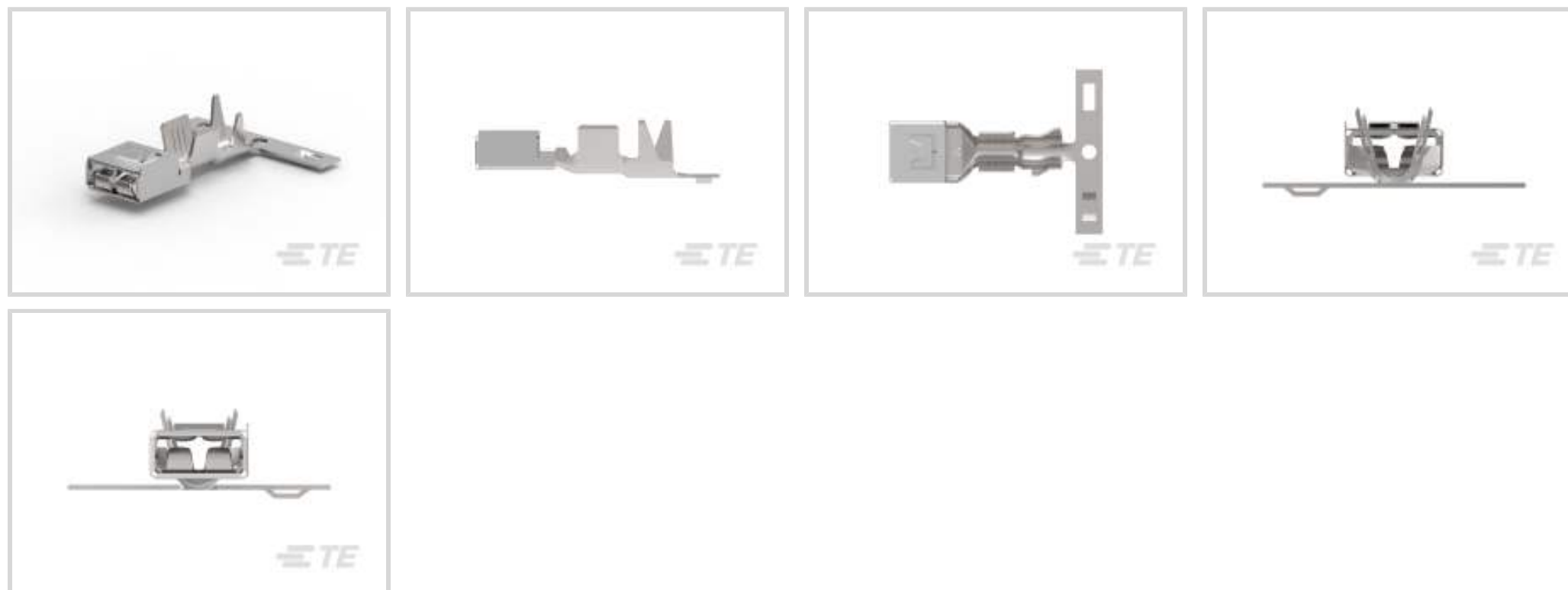

Terminal Type: **Receptacle**

Mating Tab Width: **5.2 mm [.205 in]**

Mating Tab Thickness: **.63 mm [.025 in]**

Terminal Transmits: **41 – 100 A (High Power)**

Wire Size: **12 – 11 AWG**

[All MQS, RECEPTACLE AND TAB \(126\)](#)

Features

Product Type Features

Receptacle Style	180°
Sealable	No
Primary Locking Feature	Locking Lance

Contact Features

Contact Size	5.2mm
Contact Fabrication	Stamped & Formed
Wire Contact Termination Area Plating Material	Tin
Typical Current Rating	45 A
Crimp Type	F-Crimp
Terminal Type	Receptacle
Mating Tab Width	5.2 mm[.205 in]
Mating Tab Thickness	.63 mm[.025 in]
Interface Plating	Tin (Sn)



Termination Features

Termination Method to Wire & Cable	Crimp
Product Terminates To	Wire

Dimensions

Compatible Insulation Diameter Range	3.4 – 3.7 mm [.134 – .146 in]
Wire Size	3 – 4 mm ²
Wire Size Search	11 AWG, 12 AWG

Usage Conditions

Insulation Option	Uninsulated
Operating Temperature (Max)	80 °C, 85 °C, 90 °C, 100 °C, 105 °C, 110 °C, 120 °C, 125 °C, 130 °C [176 °F][185 °F][194 °F][212 °F][221 °F][230 °F][248 °F][257 °F][266 °F]
Operating Temperature Range	-40 – 130 °C [-40 – 266 °F]

Operation/Application

Compatible With Wire Base Material	Copper
------------------------------------	--------

Industry Standards

Agency/Standard	LV214
-----------------	-------

Packaging Features

Packaging Quantity	2300
Packaging Method	Reel

Other

Terminal Transmits	41 – 100 A (High Power)
--------------------	-------------------------

Product Compliance

[For compliance documentation, visit the product page on TE.com>](#)

EU RoHS Directive 2011/65/EU	Compliant
EU ELV Directive 2000/53/EC	Compliant
China RoHS 2 Directive MIIT Order No 32, 2016	No Restricted Materials Above Threshold
EU REACH Regulation (EC) No. 1907/2006	Current ECHA Candidate List: JUNE 2023 (235) Candidate List Declared Against: JAN 2023 (233) Does not contain REACH SVHC













Halogen Content	Low Halogen - Br, Cl, F, I < 900 ppm per homogenous material. Also BFR/CFR/PVC Free
Solder Process Capability	Not applicable for solder process capability

Product Compliance Disclaimer

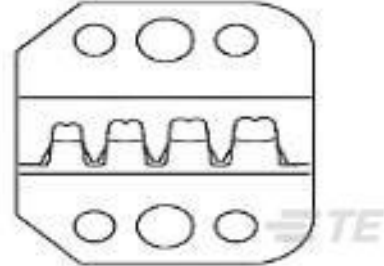
This information is provided based on reasonable inquiry of our suppliers and represents our current actual knowledge based on the information they provided. This information is subject to change. The part numbers that TE has identified as EU RoHS compliant have a maximum concentration of 0.1% by weight in homogenous materials for lead, hexavalent chromium, mercury, PBB, PBDE, DBP, BBP, DEHP, DIBP, and 0.01% for cadmium, or qualify for an exemption to these limits as defined in the Annexes of Directive 2011/65/EU (RoHS2). Finished electrical and electronic equipment products will be CE marked as required by Directive 2011/65/EU. Components may not be CE marked. Additionally, the part numbers that TE has identified as EU ELV compliant have a maximum concentration of 0.1% by weight in homogenous materials for lead, hexavalent chromium, and mercury, and 0.01% for cadmium, or qualify for an exemption to these limits as defined in the Annexes of Directive 2000/53/EC (ELV). Regarding the REACH Regulation, the information TE provides on SVHC in articles for this part number is based on the latest European Chemicals Agency (ECHA) 'Guidance on requirements for substances in articles' posted at this URL: <https://echa.europa.eu/guidance-documents/guidance-on-reach>

Compatible Parts

 <p>TE Part # 2305570-1 Strip Terminal Cutter-Side Feed-No Crimp</p>	 <p>TE Part # 2-2151579-1 OCEAN_2.0_APPLICATOR-S-120F1550</p>	 <p>TE Part # 2-2151579-2 OCEAN_2.0_APPLICATOR-S-120F1550</p>	 <p>TE Part # 2151579-1 OCEAN_2.0_APPLICATOR-S-120F1550</p>
 <p>TE Part # 2151579-2 OCEAN_2.0_APPLICATOR-S-120F1550</p>	 <p>TE Part # 58594-1 PROCRIMP PQ</p>	 <p>TE Part # 58594-2 PROCRIMP DIE PQ</p>	 <p>TE Part # 6-1579007-4 EXTRACTION TOOL</p>
 <p>TE Part # 7-2151579-1 OCEAN_2.0_APPLICATOR-S-120F1550</p>	 <p>TE Part # 7-2151579-2 OCEAN_2.0_APPLICATOR-S-120F1550</p>	 <p>TE Part # 7-2151579-7 OCEAN_2.0_SPARE_PART_KIT-120F1550</p>	

Also in the Series | **Power Quadlock**



Automotive Terminals(9)



Insertion & Extraction Tools(1)

Customers Also Bought

TE Part #2141404-1
MQS, CONNECTOR HOUSINGTE Part #2-1445091-2
MICRO MNL HDR ASSY S/ROW AU LFTE Part #968074-2
MQS, RECEPTACLE AND TABTE Part #3-1579021-7
ERGO_F.MCP6.3/4.8

Documents

Product Drawings

[PQ5,2 Sn rec LL unseal. >2,5-4](#)

English

[PQ5,2 Sn rec LL unseal. >2,5-4](#)

English

CAD Files

Customer View Model

[ENG_CVM_968073-2_C6.3d_igs.zip](#)

English

Customer View Model

[ENG_CVM_968073-2_C6.3d_stp.zip](#)

English

Customer View Model

[ENG_CVM_968073-2_C6.2d_dxf.zip](#)

English

3D PDF

English

By downloading the CAD file I accept and agree to the [Terms and Conditions](#) of use.

Datasheets & Catalog Pages

[Micro Quadlok Interconnection System \(MQS\)](#)

English

Product Specifications

[Application Specification](#)



English

[Application Specification](#)

English