

THIS DRAWING IS UNPUBLISHED. RELEASED FOR PUBLICATION
 © COPYRIGHT - By - ALL RIGHTS RESERVED.

LOC	DIST	REVISIONS					
GP	00	P	LTR	DESCRIPTION	DATE	DWN	APVD
		A		RELEASED PER ECO-11-002006	11APR2011	CJV	CWR

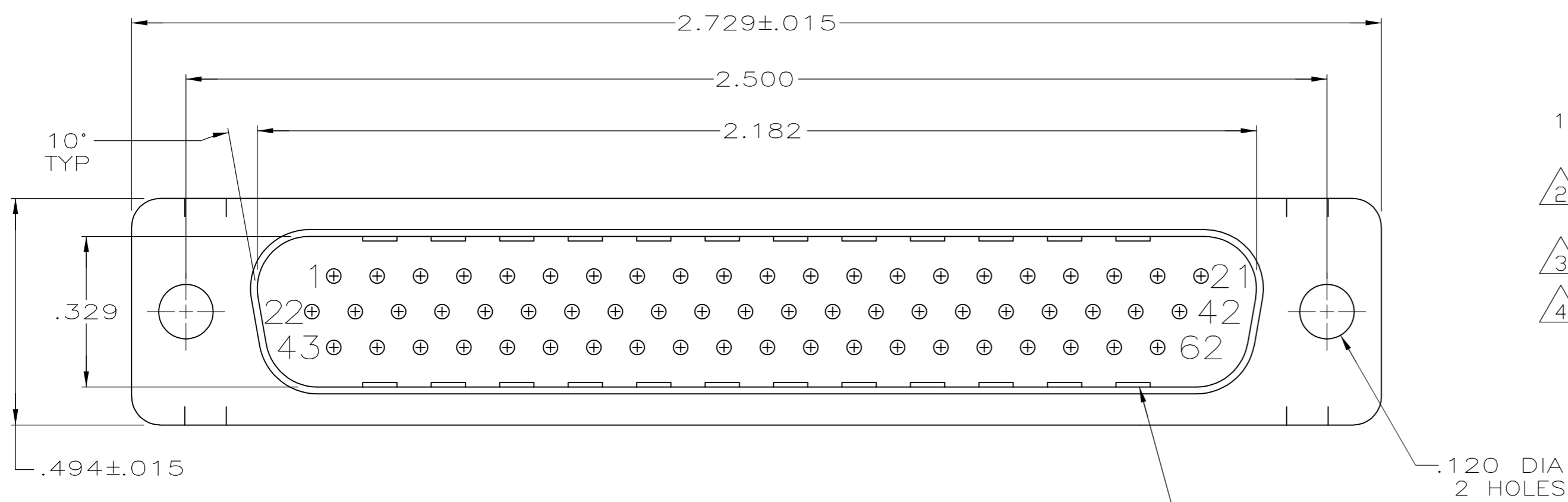

- CONNECTOR ACCEPTS 22 DF PIN CONTACTS, RETENTION TINES ARE AN INTEGRAL PART OF INSERT.
- MOLDED PART MATERIAL: FLAME RETARDANT 94V-0 RATED GLASS FILLED NYLON, COLOR: BLACK.
- SHELL MATERIAL: CARBON STEEL.
- SHELL FINISH: .000200 MIN TIN PLATE OVER .000100 MIN COPPER UNDERPLATE.

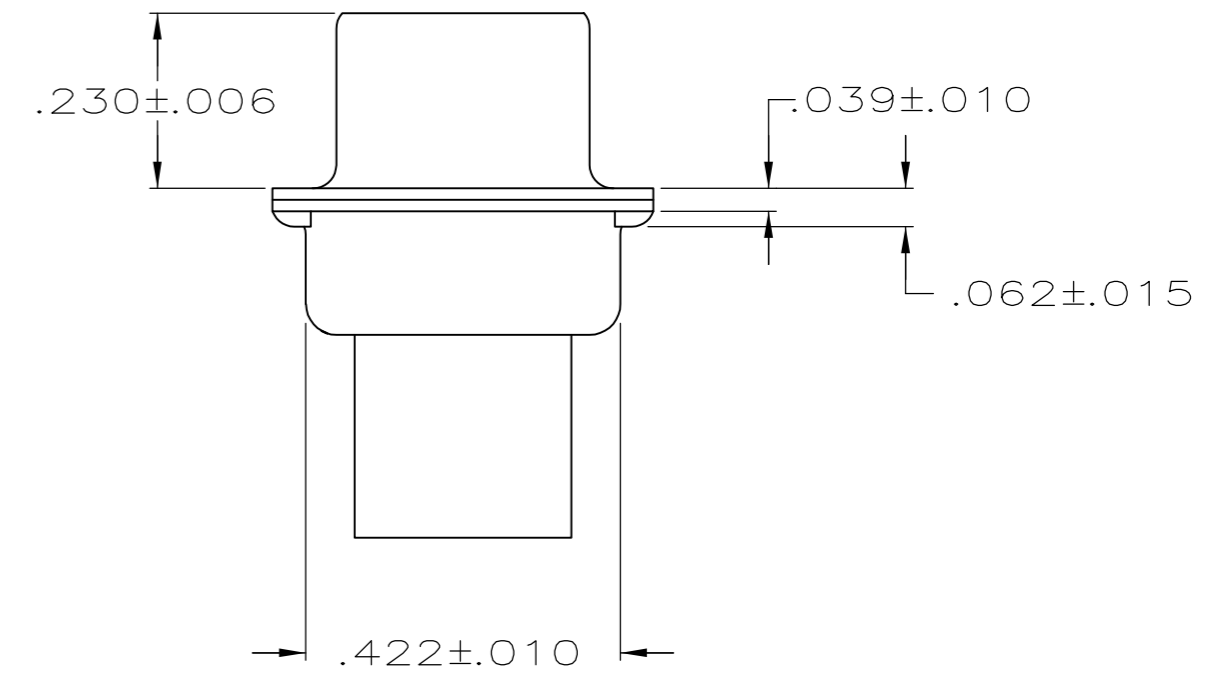
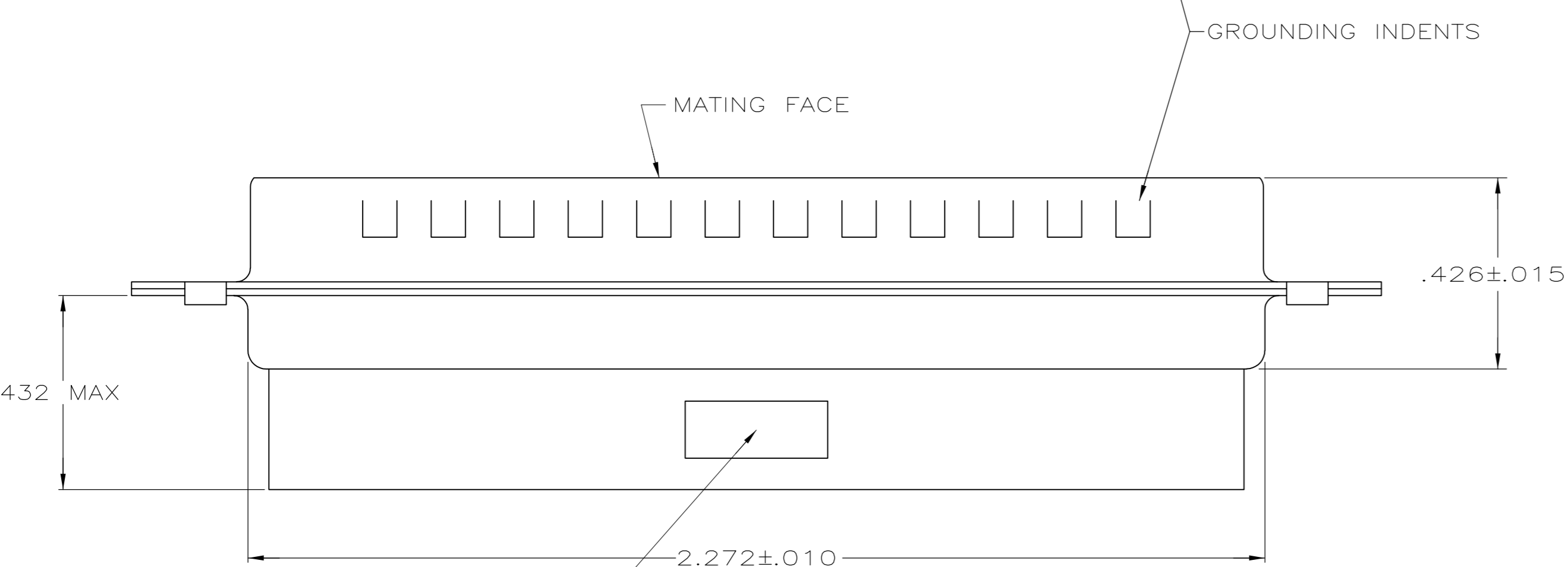

1658673-1
 PART NUMBER

THIS DRAWING IS A CONTROLLED DOCUMENT.		DWN L. BAUM 02JAN04		
DIMENSIONS: INCHES		CHK S. BOLASH 02JAN04		
TOLERANCES UNLESS OTHERWISE SPECIFIED:		APVD M. WALMSLEY 02JAN04	NAME	
0 PLC ± -		PRODUCT SPEC	PLUG ASSEMBLY, SIZE 4, 62 POSN, HDP-22, AMPLIMITE®	
1 PLC ± -		108-1268	SIZE	CAGE CODE
2 PLC ± -		APPLICATION SPEC	A2	00779
3 PLC ± .005		114-10001	DRAWING NO	RESTRICTED TO
4 PLC ± -		WEIGHT -	C=1658673	-
ANGLES ± 2°		CUSTOMER DRAWING	SCALE 4:1	SHEET 1 of 1
MATERIAL		FINISH	REV A	