

THIS DRAWING IS UNPUBLISHED. RELEASED FOR PUBLICATION 20
 © COPYRIGHT 20 BY - ALL RIGHTS RESERVED.

REVISIONS				
P	LTR	DESCRIPTION	DATE	APVD
P9		REVISED PER ECR-18-011787	10SEP2018	JB DZ
P10		REVISED PER ECN-20-100589	29OCT2020	WLS VS
P11		REVISED PER ECN-20-100715	30NOV2020	WLS VS
P12		REVISED PER ECN-23-210752	03MAY2023	WLS VS

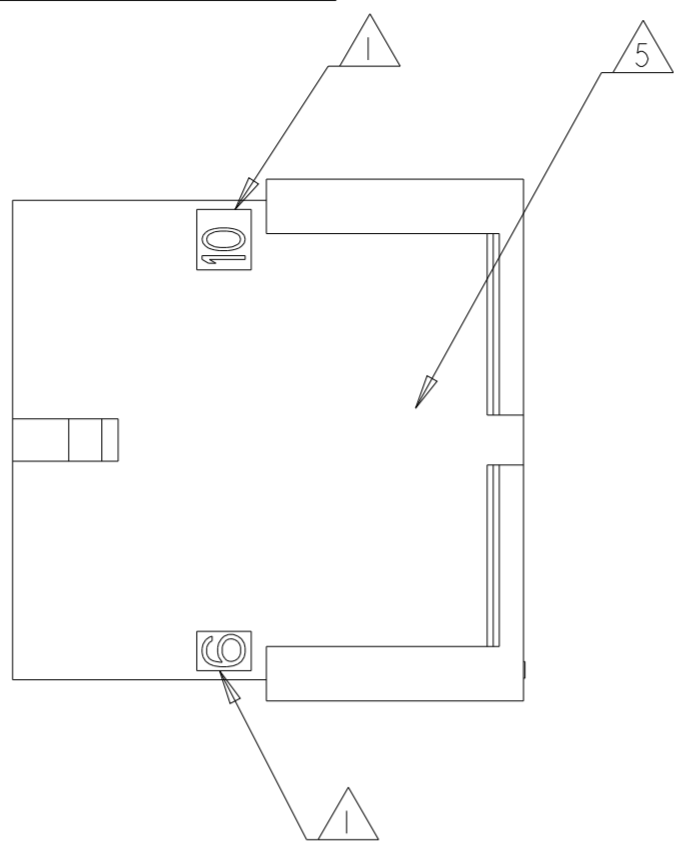

- ① CIRCUIT IDENTIFIERS LOCATED APPROXIMATELY AS SHOWN.
- ② MATERIAL PA66/6 UL94-V0.
- ③ MATERIAL PA66 UL94-V0, GWEPT 750°C AND GWFI 850°C, NO FLAME ACC. TO IEC 60335-1.
- ④ MATERIAL ID ">PA<" LOCATED IN APPROX AREA SHOWN, APPROX 0.01 HIGH.
- ⑤ CAVITY NUMBER IDENTIFICATION.

6 COUNTERPART RECOMMENDED IS PN 794617 (DASH ACC. TO NUMBER OF POSITION).

7 TERMINAL USED WITH THIS CONNECTOR CAN BE 794608 OR 794609 OR LOOSE PIECE TERMINALS MAKE FROM THEM OR OTHER APPROVED BY PRODUCT ENGINEERING (TERMINAL PN DEFINED ACC. TO WIRE SIZE AND DASH NUMBER ACC. TO FINISHING).

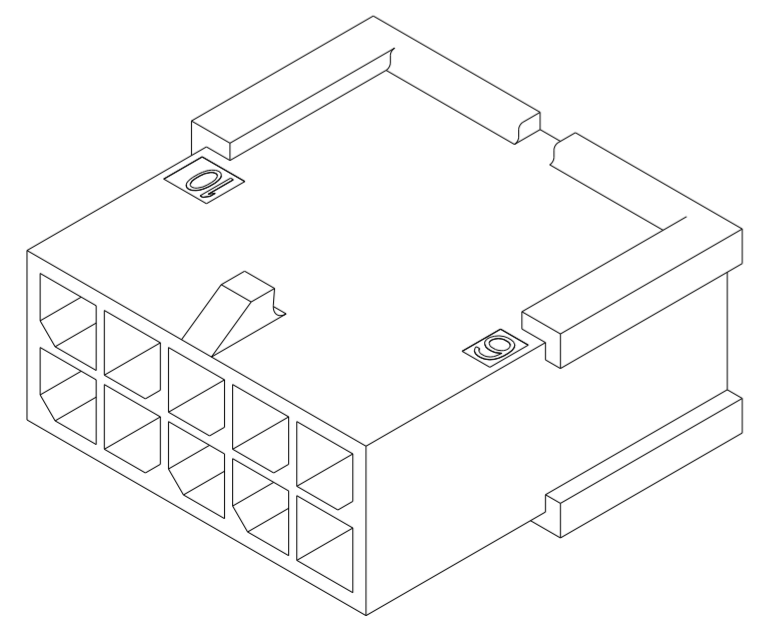
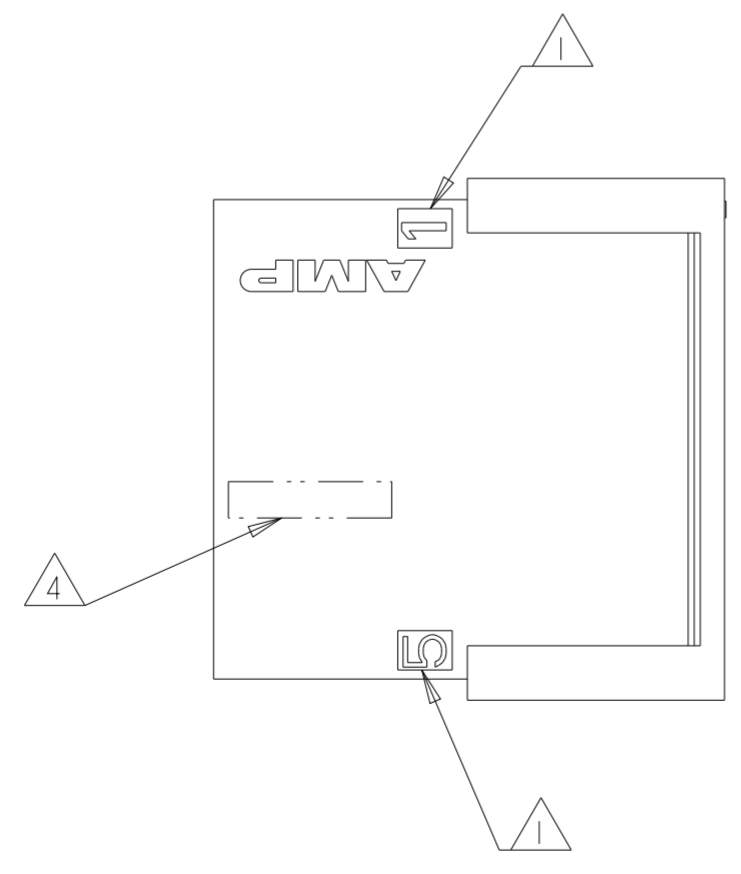
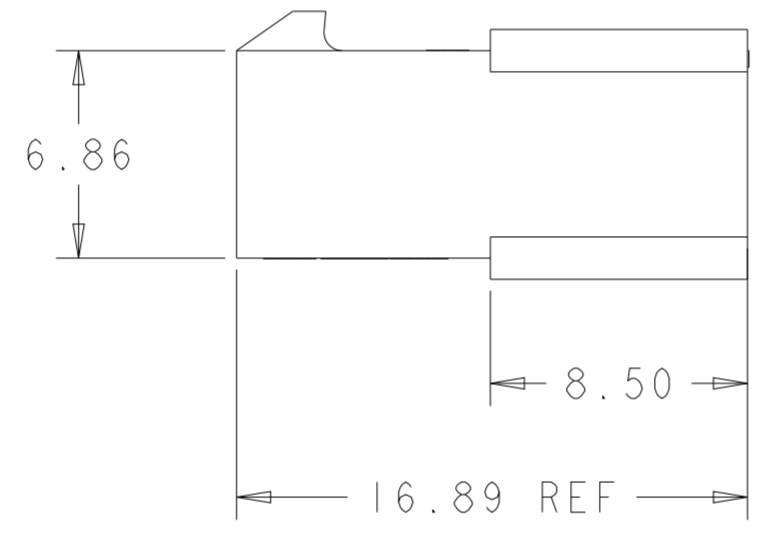
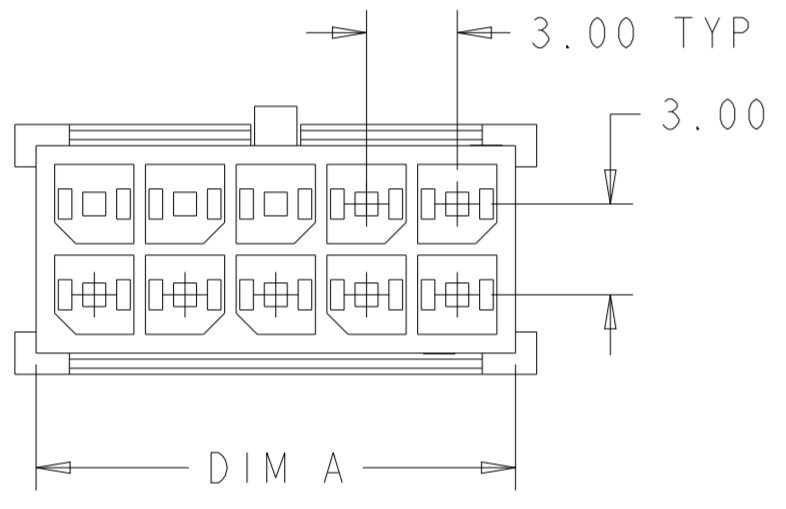

NATURAL	③	15.85	10	3-794616-0
		12.85	8	3-794616-8
		9.85	6	3-794616-6
BLACK	②	36.85	24	2-794616-4
		33.85	22	2-794616-2
		30.85	20	2-794616-0
		27.85	18	1-794616-8
		24.85	16	1-794616-6
		21.85	14	1-794616-4
		18.85	12	1-794616-2
		15.85	10	1-794616-0
		12.85	8	794616-8
		9.85	6	794616-6
		6.85	4	794616-4
3.85	2	794616-2		
COLOR	MATERIAL	DIM A	NO. OF POS.	PART NUMBER

THIS DRAWING IS A CONTROLLED DOCUMENT.

DIMENSIONS: mm	TOLERANCES UNLESS OTHERWISE SPECIFIED:	DWN W J RUDY 29AUG2000	TE Connectivity
	0 PLC ±	CHK W DAVIS 29AUG2000	
	1 PLC ±	APVD W DAVIS 29AUG2000	
	2 PLC ±0.26	PRODUCT SPEC	
MATERIAL SEE TABLE	FINISH -	108-1836	NAME PLUG HOUSING, 2 to 24 POSITION DUAL ROW, FREE HANGING, MICRO MATE-N-LOK(TM)
		114-13000	SIZE A2
			CAGE CODE 00779
			DRAWING NO C-794616
			RESTRICTED TO
			SCALE 4:1
			SHEET 1 OF 2
			REV P12

THIS DRAWING IS UNPUBLISHED. RELEASED FOR PUBLICATION 20
 © COPYRIGHT 20 BY - ALL RIGHTS RESERVED.

REVISIONS					
P	LTR	DESCRIPTION	DATE	DWN	APVD
-	-	SEE SHEET 1	-	-	-

2 POS.

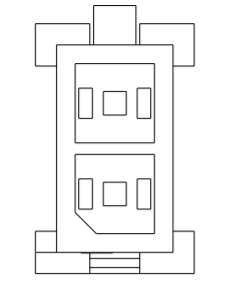

14 POS.

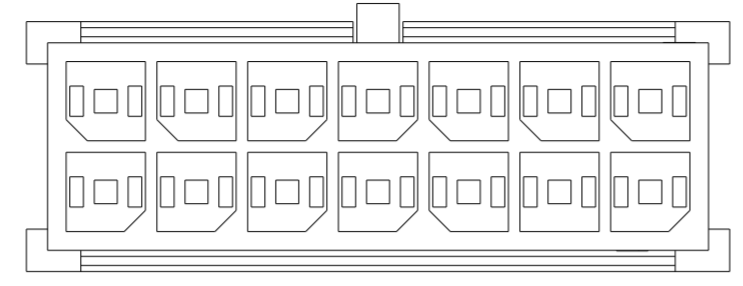

4 POS.

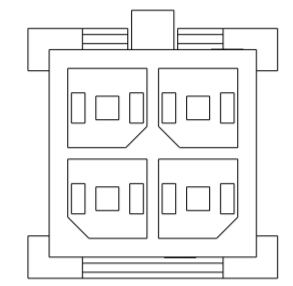

16 POS.

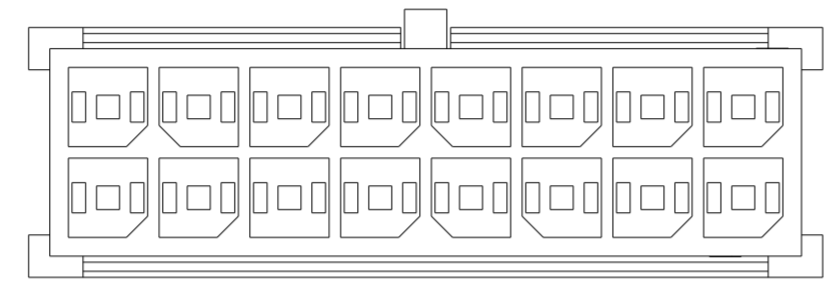

6 POS.

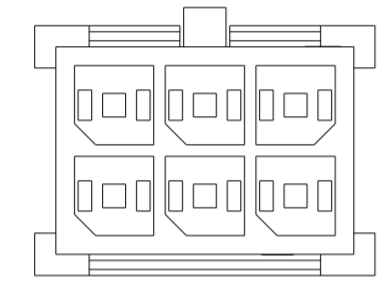

18 POS.

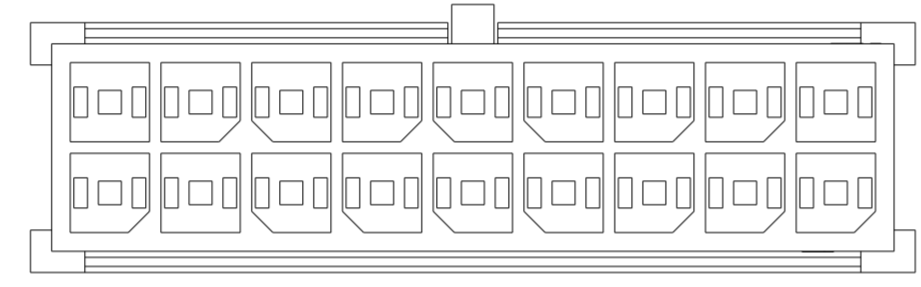

8 POS.

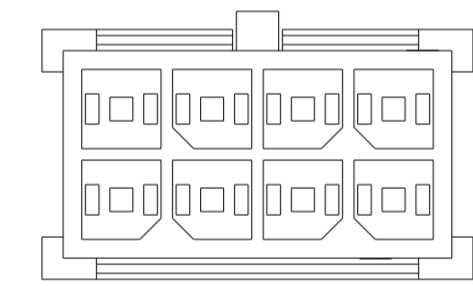

20 POS.

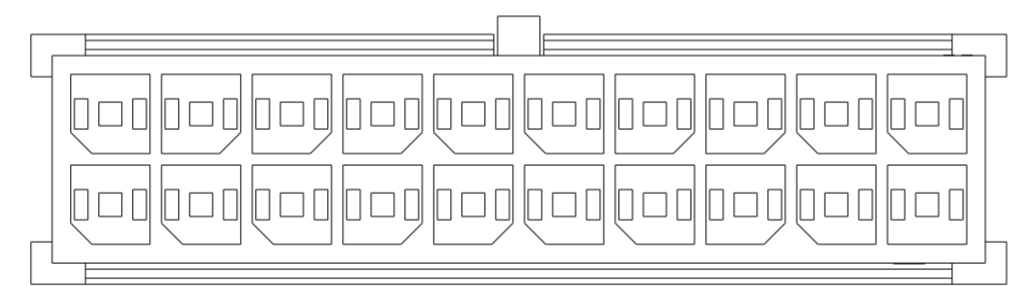

10 POS.

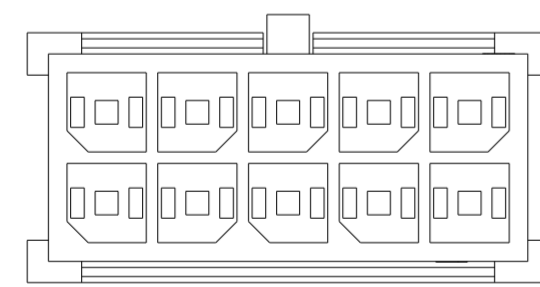

22 POS.

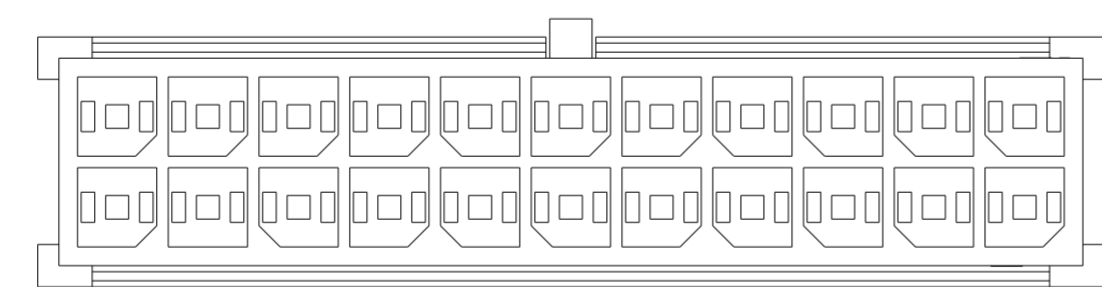

12 POS.

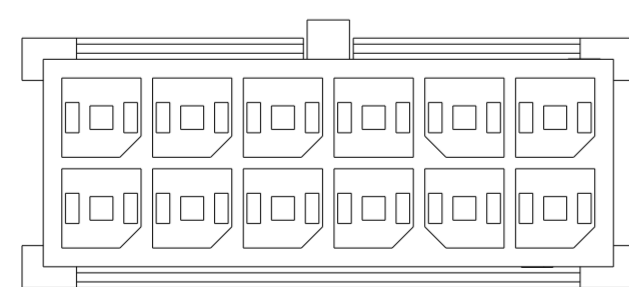

24 POS.

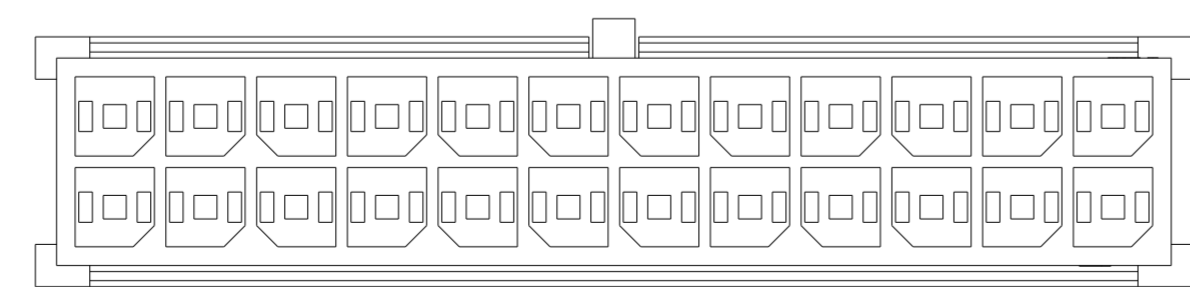

KEYING BY POSITION SIZE

THIS DRAWING IS A CONTROLLED DOCUMENT.		DWN W J RUDY 29AUG2000	 TE Connectivity	NAME PLUG HOUSING, 2 to 24 POSITION DUAL ROW, FREE HANGING, MICRO MATE-N-LOK(TM)		
DIMENSIONS: mm		CHK W DAVIS 29AUG2000		SIZE 108-1836	CAGE CODE A200779	DRAWING NO C-794616
TOLERANCES UNLESS OTHERWISE SPECIFIED:		APVD W DAVIS 29AUG2000		APPLICATION SPEC 114-13000	RESTRICTED TO	
0 PLC ± 1 PLC ± 2 PLC ±0.26 3 PLC ± 4 PLC ± ANGLES ±° FINISH		MATERIAL -		WEIGHT -	SCALE 4:1	SHEET 2 OF 2
CUSTOMER DRAWING			REV P12			