

# TTC-6P-3-HF-F-M-EX-24DC-UT-I - Surge protection device



2906828

<https://www.phoenixcontact.com/us/products/2906828>

Please be informed that the data shown in this PDF document is generated from our online catalog. Please find the complete data in the user documentation. Our general terms of use for downloads are valid.



Surge protection with integrated status indicator and knife disconnection for a 3-wire Ex i signal circuit with common reference potential. For HF applications. Indirect grounding via gas discharge tube, HART-compatible. Suitable for use in the fieldbus system (e.g., PROFIBUS PA) in accordance with the FISCO concept, APL ready.

## Your advantages

- Space-saving and cost-saving with a narrow overall width of just 6 mm
- Continuous monitoring of protective devices, plus mechanical status indicator with optional remote signaling
- Finding the right product for all possible requirements in MCR applications is easy, thanks to the complete range of products with customized features
- Easy testing and documentation with CHECKMASTER 2 with pluggable protective modules
- The signal is not influenced during maintenance work, thanks to the impedance-neutral insertion and removal of protective plugs

## Commercial data

Item number	2906828
Packing unit	1 pc
Minimum order quantity	1 pc
Sales key	CL23
Product key	CL2163
Catalog page	Page 181 (C-4-2019)
GTIN	4055626135892
Weight per piece (including packing)	67.3 g
Weight per piece (excluding packing)	42.78 g
Customs tariff number	85363010
Country of origin	DE

# TTC-6P-3-HF-F-M-EX-24DC-UT-I - Surge protection device



2906828

<https://www.phoenixcontact.com/us/products/2906828>

## Technical data

### Product properties

IEC test classification	C1
	C2
	C3
	D1
Type	DIN rail module, two-section, divisible
Product type	Surge protection for information technology
Product family	TERMITRAB complete

### Insulation characteristics

Overvoltage category	III
Pollution degree	2

### Electrical properties

Nominal voltage $U_N$	24 V DC
-----------------------	---------

### Connection data

Connection method	Screw connection
Screw thread	M3
Tightening torque	0.5 Nm ... 0.6 Nm
Conductor cross section flexible	0.2 mm <sup>2</sup> ... 2.5 mm <sup>2</sup>
Conductor cross section rigid	0.2 mm <sup>2</sup> ... 4 mm <sup>2</sup>
Conductor cross section AWG	24 ... 12

### Ex data

Maximum inner capacitance $C_i$	negligible
Max. internal inductance $L_i$	negligible
Max. input current $I_i$	400 mA (T4 / -40 °C ... +50 °C)
	250 mA (T4 / -40 °C ... +70 °C)
	350 mA (T6 / -40 °C ... +35 °C)
	100 mA (T6 / -40 °C ... +70 °C)
Max. input voltage $U_i$	30 V DC
Insulation voltage to ground	> 180 V DC
Ambient temperature (operation)	-40 °C ... 70 °C (with current derating)

### Dimensions

Dimensional drawing	
Width	6.2 mm +0.1 mm

# TTC-6P-3-HF-F-M-EX-24DC-UT-I - Surge protection device



2906828

<https://www.phoenixcontact.com/us/products/2906828>

Height	105.8 mm
Depth	100 mm (incl. DIN rail 7.5 mm)

## Material specifications

Flammability rating according to UL 94	V-0
Insulating material	PBT
Housing material	PBT

## Mechanical properties

### Mechanical data

Open side panel	No
-----------------	----

## Protective circuit

Direction of action	Line-Line & Line-Signal Ground/Shield & optional Signal Ground/Shield-Earth Ground
Maximum continuous voltage $U_C$	30 V DC
Rated current	600 mA (40 °C)
Operating effective current $I_C$ at $U_C$	$\leq 5 \mu\text{A}$
Residual current $I_{PE}$	$\leq 1 \mu\text{A}$
Nominal discharge current $I_n$ (8/20) $\mu\text{s}$ (line-line)	5 kA
Nominal discharge current $I_n$ (8/20) $\mu\text{s}$ (line-ground)	5 kA
Nominal discharge current $I_n$ (8/20) $\mu\text{s}$ (line-signal ground)	5 kA
Pulse discharge current $I_{imp}$ (10/350) $\mu\text{s}$ (line-line)	0.5 kA
Pulse discharge current $I_{imp}$ (10/350) $\mu\text{s}$ (line-earth)	0.5 kA
Pulse discharge current $I_{imp}$ (10/350) $\mu\text{s}$ (line-signalground)	0.5 kA
Total discharge current $I_{total}$ (8/20) $\mu\text{s}$	10 kA
Voltage protection level $U_p$ (line-line)	$\leq 150 \text{ V}$ (C1 - 1 kV / 500 A)
	$\leq 275 \text{ V}$ (C2 - 10 kV / 5 kA)
	$\leq 55 \text{ V}$ (C3 - 100 A)
Voltage protection level $U_p$ (line-earth)	$\leq 750 \text{ V}$ (C1 - 1 kV / 500 A)
	$\leq 750 \text{ V}$ (C2 - 10 kV / 5 kA)
	$\leq 1.2 \text{ kV}$ (C3 - 100 A)
Voltage protection level $U_p$ (line-signalground)	$\leq 80 \text{ V}$ (C1 - 1 kV / 500 A)
	$\leq 125 \text{ V}$ (C2 - 10 kV / 5 kA)
	$\leq 55 \text{ V}$ (C3 - 100 A)
Voltage protection level $U_p$ static (line-line)	$\leq 75 \text{ V}$ (C1 - 1 kV / 500 A)
	$\leq 120 \text{ V}$ (C2 - 10 kV / 5 kA)
Voltage protection level $U_p$ static (line-earth)	$\leq 750 \text{ V}$ (C1 - 1 kV / 500 A)
	$\leq 750 \text{ V}$ (C2 - 10 kV / 5 kA)
Voltage protection level $U_p$ static (line-signalground)	$\leq 75 \text{ V}$ (C1 - 1 kV / 500 A)
	$\leq 120 \text{ V}$ (C2 - 10 kV / 5 kA)
Response time $t_A$ (line-line)	$\leq 1 \text{ ns}$
Response time $t_A$ (line-earth)	$\leq 100 \text{ ns}$
Response time $t_A$ (line-signalground)	$\leq 1 \text{ ns}$

# TTC-6P-3-HF-F-M-EX-24DC-UT-I - Surge protection device



2906828

<https://www.phoenixcontact.com/us/products/2906828>

Input attenuation aE, sym.	typ. 0.3 dB ( $\leq$ 8.7 MHz / 150 $\Omega$ )
Input attenuation aE, asym.	typ. 0.3 dB ( $\leq$ 10.5 MHz / 150 $\Omega$ )
Cut-off frequency fg (3 dB), sym. in 150 $\Omega$ system	typ. 60 MHz
Cut-off frequency fg (3 dB), asym. (signal ground) in 150 $\Omega$ system	typ. 60 MHz
Capacity (Core-Core)	typ. 32 pF
Capacity (line-signalground)	typ. 32 pF
Resistance per path	1.65 $\Omega$ $\pm$ 20 %
Surge protection fault message	optical
Max. required back-up fuse	630 mA (FF)
Impulse durability (line-line)	C1 - 1 kV / 500 A
	C2 - 10 kV / 5 kA
	C3 - 100 A
Impulse durability (line-earth)	C1 - 1 kV / 500 A
	C2 - 10 kV / 5 kA
	C3 - 100 A
	D1 - 500 A
Impulse durability (line-signalground)	C1 - 1 kV / 500 A
	C2 - 10 kV / 5 kA
	C3 - 100 A
	D1 - 500 A
Pulse reset time (line-line)	$\leq$ 600 ms
Pulse reset time (line-earth)	$\leq$ 30 ms
Pulse reset time (line-signalground)	$\leq$ 600 ms

## Environmental and real-life conditions

### Ambient conditions

Degree of protection	IP20
Ambient temperature (operation)	-40 °C ... 85 °C
Ambient temperature (storage/transport)	-40 °C ... 85 °C
Altitude	$\leq$ 2000 m (amsl)
Permissible humidity (operation)	5 % ... 95 %

## Approvals

### Conformity/Approvals

UL, USA / Canada	Class I, Div. 2, Groups A, B, C, D T4A
------------------	--

## Standards and regulations

Standards/specifications	EN 60079-0
Note	2018
Standards/specifications	EN 60079-11
Note	2012

EN 61643-21

# TTC-6P-3-HF-F-M-EX-24DC-UT-I - Surge protection device



2906828

<https://www.phoenixcontact.com/us/products/2906828>

Standards/specifications	EN 61643-21
Note	2001 + A1:2009 + A2:2013
Standards/specifications	IEC 60079-0
Note	2017
Standards/specifications	IEC 60079-11
Note	2008
Standards/specifications	IEC 61643-21
Note	2000 + corrigendum 2001 + A1:2008, modified + A2:2012

## Mounting

Mounting type	DIN rail: TH 35 - 7.5 mm
---------------	--------------------------

# TTC-6P-3-HF-F-M-EX-24DC-UT-I - Surge protection device



2906828

<https://www.phoenixcontact.com/us/products/2906828>

## Drawings

Diagram

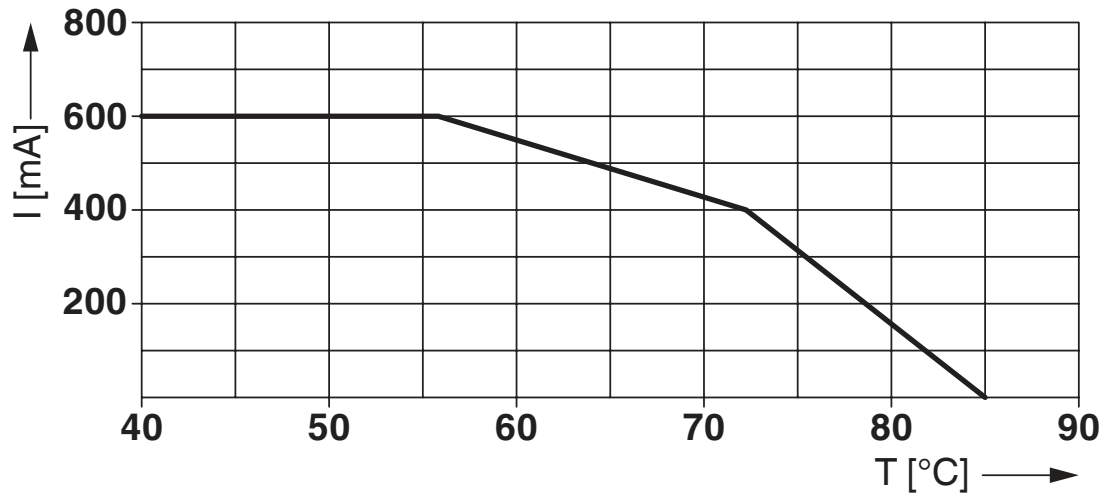

Derating for non-Ex applications

Dimensional drawing

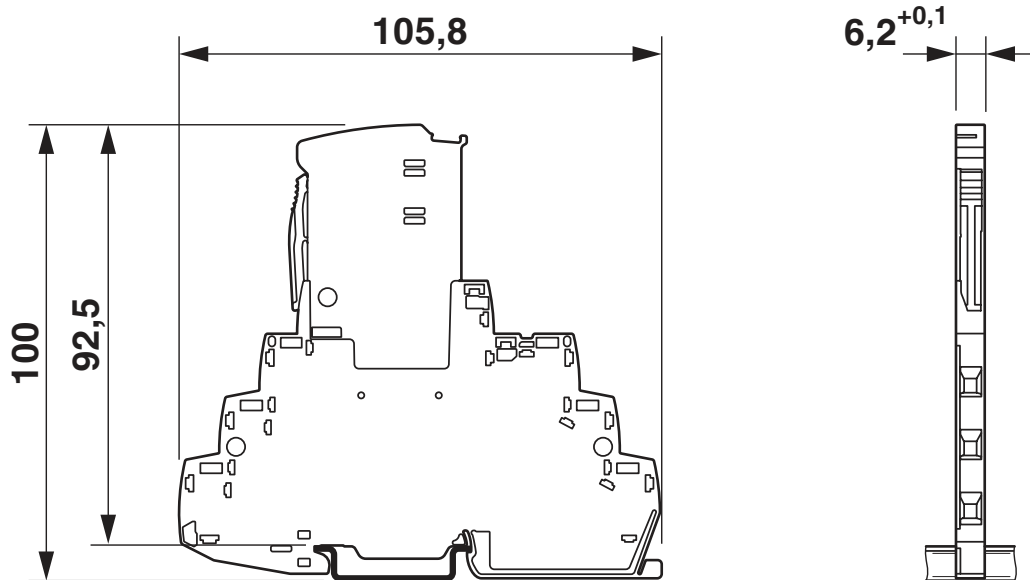

# TTC-6P-3-HF-F-M-EX-24DC-UT-I - Surge protection device



2906828

<https://www.phoenixcontact.com/us/products/2906828>

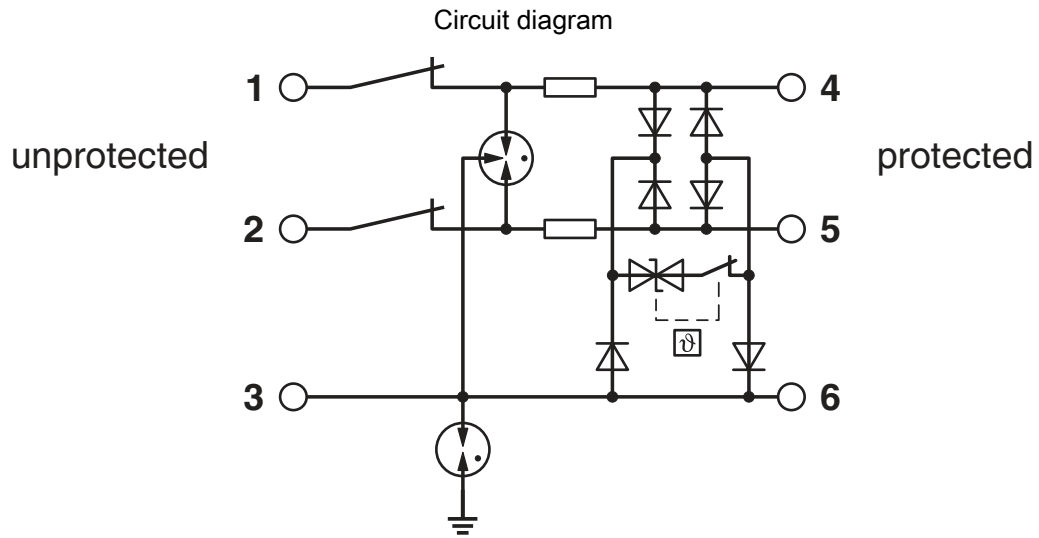

# TTC-6P-3-HF-F-M-EX-24DC-UT-I - Surge protection device



2906828

<https://www.phoenixcontact.com/us/products/2906828>

## Approvals

To download certificates, visit the product detail page: <https://www.phoenixcontact.com/us/products/2906828>

 **CSA**  
Approval ID: 70136717

 **DNV GL**  
Approval ID: TAE000027G

 **UL Listed**  
Approval ID: FILE E 138168

 **CSAus**  
Approval ID: 70136717

**UAE-RoHS**  
Approval ID: 22-06-16783

 **IECEX**  
Approval ID: IECEX BVS 16.0090X

 **CCC**  
Approval ID: 2020322316000780

 **cUL Listed**  
Approval ID: FILE E 333250

 **UL Listed**  
Approval ID: FILE E 333250

 **ATEX**  
Approval ID: BVS 16 ATEX E 125 X

**INMETRO**  
Approval ID: DNV 19.0077 X



# TTC-6P-3-HF-F-M-EX-24DC-UT-I - Surge protection device



2906828

<https://www.phoenixcontact.com/us/products/2906828>



**NEPSI-EX**

Approval ID: GYJ20.1114X

**cCSAus**

**cULus Listed**

# TTC-6P-3-HF-F-M-EX-24DC-UT-I - Surge protection device



2906828

<https://www.phoenixcontact.com/us/products/2906828>

## Classifications

### ECLASS

ECLASS-11.0	27130807
ECLASS-13.0	27171502

### ETIM

ETIM 8.0	EC000943
----------	----------

### UNSPSC

UNSPSC 21.0	39121600
-------------	----------

# TTC-6P-3-HF-F-M-EX-24DC-UT-I - Surge protection device



2906828

<https://www.phoenixcontact.com/us/products/2906828>

## Environmental product compliance

REACH SVHC	Lead 7439-92-1
China RoHS	Environmentally Friendly Use Period = 50 years
	For information on hazardous substances, refer to the manufacturer's declaration available under "Downloads"

# TTC-6P-3-HF-F-M-EX-24DC-UT-I - Surge protection device



2906828

<https://www.phoenixcontact.com/us/products/2906828>

## Accessories

### ZBF 6 CUS - Zack Marker strip, flat

0825027

<https://www.phoenixcontact.com/us/products/0825027>



Zack Marker strip, flat, Strip, can be ordered: Strip, white, labeled according to customer specifications, mounting type: snap into flat marker groove, for terminal block width: 6.2 mm, lettering field size: 5.15 x 6.15 mm, Number of individual labels: 10

---

### ZBF 6:UNBEDRUCKT - Zack Marker strip, flat

0808710

<https://www.phoenixcontact.com/us/products/0808710>



Zack Marker strip, flat, Strip, white, unlabeled, can be labeled with: PLOTMARK, CMS-P1-PLOTTER, mounting type: snapped, for terminal block width: 6.2 mm, lettering field size: 5.15 x 6.15 mm, Number of individual labels: 10

# TTC-6P-3-HF-F-M-EX-24DC-UT-I - Surge protection device



2906828

<https://www.phoenixcontact.com/us/products/2906828>

## ZBF 6/WH-100:UNBEDRUCKT - Zack Marker strip, flat

0808736

<https://www.phoenixcontact.com/us/products/0808736>



Zack Marker strip, flat, Strip, white, unlabeled, can be labeled with: PLOTMARK, CMS-P1-PLOTTER, mounting type: snapped, for terminal block width: 6.2 mm, lettering field size: 5.15 x 6.15 mm, Number of individual labels: 1000

---

## ZBF 6,QR:FORTL.ZAHLEN - Zack Marker strip, flat

0808765

<https://www.phoenixcontact.com/us/products/0808765>



Zack Marker strip, flat, Strip, white, labeled, Printed vertically: consecutive numbers 1 ... 10, 11 ... 20, etc. up to 91 ... 100, mounting type: snapped, for terminal block width: 6.2 mm, lettering field size: 5.15 x 6.15 mm, Number of individual labels: 10

# TTC-6P-3-HF-F-M-EX-24DC-UT-I - Surge protection device



2906828

<https://www.phoenixcontact.com/us/products/2906828>

## CLIPFIX 35-5 - End clamp

3022276

<https://www.phoenixcontact.com/us/products/3022276>



Quick mounting end clamp for NS 35/7,5 DIN rail or NS 35/15 DIN rail, with marking option, with parking option for FBS...5, FBS...6, KSS 5, KSS 6, width: 5.15 mm, color: gray

---

## TTC-6-FMRS-UT - Remote signaling set

2907810

<https://www.phoenixcontact.com/us/products/2907810>



Module set for the optical monitoring and floating remote signaling of adjacent surge protective devices in the TERMITRAB complete or CLIXTRAB product family. Suitable for directly grounded DIN rails.

# TTC-6P-3-HF-F-M-EX-24DC-UT-I - Surge protection device



2906828

<https://www.phoenixcontact.com/us/products/2906828>

## TTC-EX-PP - Separating plate

1011977

<https://www.phoenixcontact.com/us/products/1011977>

Partition plate for NS-35/7,5 DIN rails to ensure a clearance of 50 mm between the remote signaling module and surge protection in TTC-EX systems.



---

## SSA 3-6 - Shield connection

2839295

<https://www.phoenixcontact.com/us/products/2839295>

Shield fast connection for 3 ... 6 mm cable diameter. Potential connecting cable: 200 mm, 1 mm<sup>2</sup>, color: black



# TTC-6P-3-HF-F-M-EX-24DC-UT-I - Surge protection device



2906828

<https://www.phoenixcontact.com/us/products/2906828>

## SSA 5-10 - Shield connection

2839512

<https://www.phoenixcontact.com/us/products/2839512>



Shield fast connection for 5 ... 10 mm cable diameter. Potential connecting cable: 200 mm, 1 mm<sup>2</sup>, color: black

---

## X-PEN 0,35 - Marker pen

0811228

<https://www.phoenixcontact.com/us/products/0811228>



Marker pen without ink cartridge, for manual labeling of markers, labeling extremely wipe-proof, line thickness 0.35 mm



# TTC-6P-3-HF-F-M-EX-24DC-UT-I - Surge protection device



2906828

<https://www.phoenixcontact.com/us/products/2906828>

## TTC-6P-3-HF-EX-24DC-I-P - Surge protection plug

2907834

<https://www.phoenixcontact.com/us/products/2907834>



Surge protection plug with integrated status indicator for a 3-wire Ex i signal circuit with common reference potential. For HF applications. Nominal voltage: 24 V DC

---

Phoenix Contact 2023 © - all rights reserved

<https://www.phoenixcontact.com>

Phoenix Contact USA  
586 Fulling Mill Road  
Middletown, PA 17057, United States  
(+717) 944-1300  
[info@phoenixcon.com](mailto:info@phoenixcon.com)