



145 Royal Crest Court Unit 42 Markham, ON, Canada L3R 9Z4
Tel: 905-477-1166 Fax: 905-477-1782 <http://www.orientdisplay.com>

SPECIFICATION FOR LCD MODULE

Part No.: AMG12864P-G

Rev: F00

Issued Date: 2008-7-21

Engineering Dept.			Checked	Approved	Customer Approved
Prepared					
LCD	LCM				

Table of Contents

1 General Specifications	3
2 Mechanical Diagram	4
3 I/O Terminal	6
3.1 Pin Description.....	6
3.2 Block Diagram and Application Circuit.....	7
4 Electro-optical Specifications	8
4.1 Absolute Maximum Ratings.....	8
4.2 Optical Characteristics ⁽¹⁾	8
4.3 Electrical Characteristics	8
4.4 Timing Characteristics	9
5 Programming.....	15
5.1 Instruction Table.....	15
5.2 Display Data RAM	16
Appendix.....	17
1 Packing Method	17
2 Definitions of Optical Characteristic.....	18
2.1 Contrast Ratio Test	18
2.2 Response time.....	19
2.3 Viewing Angle	20
3 Quality Units	21
3.1 Visual and Technological Inspection	21
3.2 Visual Inspection Standard:	22
3.3 Display Inspection Standard:.....	24
4 Reliability-TEST.....	25
4.1. Standard Specifications for Reliability	25
4.2 Life Time:.....	26

Revision History

Rev.	Comment	Date
A00	Original Version	2006-10-18
C00	Modify the LCD mode to blue mode ,transflective,12:00	2006-12-11
D00	Increase The Luminosity of the Display and type of LED	2007-10-11
D01	Modify the LCD Mode to transmissive and Supply Voltage For Logic	2007-11-6
D02	Modify a mistake of Active Area	2007-11-7
F00	Change the Booster circuit of FPC to 4x boost voltage	2008-7-21

1 General Specifications

Item	<input checked="" type="checkbox"/> Standard Value	Unit
Display Pattern	<input checked="" type="checkbox"/> Graphic <input type="checkbox"/> Character <input type="checkbox"/> Segment <input type="checkbox"/> _____ <input type="checkbox"/> with ICON	
Color	<input checked="" type="checkbox"/> Mono. <input type="checkbox"/> Grayscale <input type="checkbox"/> _____	
Module Dimension (W x H x T)	72.4(W)X87.6(H)X(5.9)(T)	mm
Viewing Area (W x H)	70(W)X37(H)	mm
Active Area (W x H)	65.265(W)X32.625(H)	mm
Character Size (W x H)	\	mm
Character Pitch (W x H)	\	mm
DOT Size (W x H)	0.495(W)• 0.495(H)	mm
DOT Pitch (W x H)	0.51(W)• 0.51(H)	mm
LCD Type	<input type="checkbox"/> TN, Positive <input type="checkbox"/> TN, Negative <input type="checkbox"/> HTN, Positive <input type="checkbox"/> HTN, Negative	
	<input type="checkbox"/> STN, Yellow-Green <input type="checkbox"/> STN, Gray <input checked="" type="checkbox"/> STN, Blue <input type="checkbox"/> FSTN, Positive <input type="checkbox"/> FSTN, Negative	
	<input type="checkbox"/> _____ <input type="checkbox"/> FM LCD <input type="checkbox"/> Color STN	
Polarizer Type	<input type="checkbox"/> Transflective <input checked="" type="checkbox"/> Transmissive <input type="checkbox"/> Reflective <input type="checkbox"/> Anti-Glare	
View Direction	<input type="checkbox"/> 6H <input checked="" type="checkbox"/> 12H <input type="checkbox"/> _____	
LCD Controller & Driver	ST7565P (or Equivalent)	
LCD Driving Method	1/65duty, 1/9bias	
Interface Type	Serial <input type="checkbox"/> I ² C <input checked="" type="checkbox"/> 4-line SPI <input type="checkbox"/> 3-line SPI <input type="checkbox"/> _____	
	Parallel <input checked="" type="checkbox"/> 6800 <input checked="" type="checkbox"/> 8080 <input type="checkbox"/> 4-bit <input type="checkbox"/> _____	
Backlight Type	<input checked="" type="checkbox"/> LED <input type="checkbox"/> Bottom <input checked="" type="checkbox"/> Single Side <input type="checkbox"/> Dual Side	
	<input type="checkbox"/> _____ <input type="checkbox"/> EL <input type="checkbox"/> CCFL	
Backlight Color	<input type="checkbox"/> Yellow-Green <input checked="" type="checkbox"/> White <input type="checkbox"/> Amber <input type="checkbox"/> Blue <input type="checkbox"/> Red <input type="checkbox"/> _____	
EL/CCFL Driver type	<input type="checkbox"/> Build-in <input type="checkbox"/> External	
DC-DC Converter	<input checked="" type="checkbox"/> Build-in <input type="checkbox"/> External	
Operation Temperature	T _{OPL} = -20 T _{OPH} = +70	• •
Storage Temperature	T _{STL} = -30 T _{STH} = +80	• •

2 Mechanical Diagram

Top View Dimensions:
 Overall width: 87.6, 82, 21, 20, 84.05, 1, 27.7, 50.4±0.2(BL), 5.387, 3.2, 1.2, 41±0.2(LCD), 48±0.2(LCD), 5.568, 3.2, 1.2, 76.4±0.2(BL), 74±0.2(LCD), 70(V.A), 65.265(A.A), 42.7, 4.56, 3.85, 1.7, 1.2, 8±0.2

Side View Dimensions:
 Overall height: 4.9, 2.7, 0.3±0.05, 0.34±0.05, STIFFENER, FPC, 2-0.7(LCD), 4.4, 5.9(MAX), 0.5, 18, 40, 37.1, 6.85

Detail View Dimensions:
 PITCH(20-1)=19±0.1 (W=0.6), 1, 20, 1, 20

Labels and Notes:
 Viewing direction
 128X96 DOTS
 PROTECTIVE TAPE
 CONTACT SIDE
 COMPONENT AREA
 C00
 DISPLAY PATTERN
 0.495, 0.015, 0.015, 0.495

Backlight Circuit:
 3 LEDs
 Color: White
 Backlight Circuit

Customer Approval:
 APPROVAL: [Signature]

NO	Part Name	Quantity
5	PROTECTIVE TAPE	1
4	Backlight(5455)	1
3	FPC(5455)	1
2	IC	1
1	LCD(5455)	1

Customer Information:
 CUSTOMER: [Blank]
 LCM NO: AMG12864P-G
 DWG NO: AMG12864P-G
 Rev: 00
 UNITS: mm
 SHEET 1 OF 2

Approval and Dates:
 APPROVED: [Signature]
 CHECKED: [Signature]
 DRAWN: [Signature]
 2011-07-11, 2011-07-11, 2011-07-11

Block Diagram:

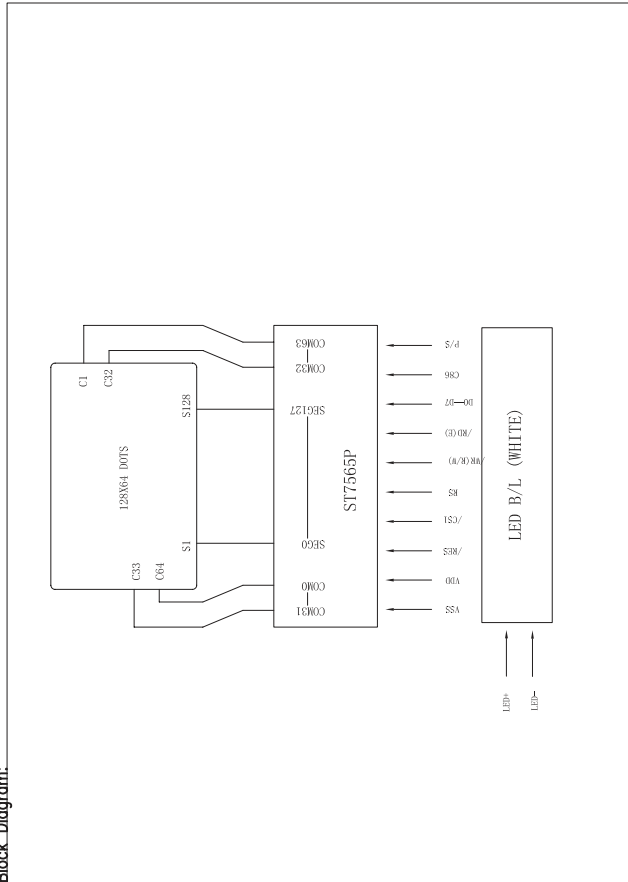

DISPLAY TYPE: STN/BLUE, Transmission, Negative
 VIEWING DIRECTION: 12:00
 DRIVER IC: ST7565P

LOGIC VOLTAGE: 3.0V(3.5V MAX)

LCD DRIVE VOLTAGE(Vlcd): 10.3V

DRIVING METHOD: 1/65 DUTY, 1/9 BIAS

Backlight:White

Iled=45mA Vled=5.0±0.3V

OPERATING TEMPERATURE: -20° ~ +70°C

STORAGE TEMPERATURE: -30° ~ +80°C

INTERFACE CONNECTOR: FPC

All UNMARKED TOLERANCE: ±0.3mm

PIN CONNECTION

NO	SYMBOL
1	VSS
2	VDD
3	NC
4	/RES
5	/CS1
6	RS
7	/WR (R/W)
8	/RD (E)
9	D0
10	D1
11	D2
12	D3
13	D4
14	D5
15	D6
16	D7
17	C86
18	P/S
19	LED+
20	LED-



ORIENT DISPLAY (North America) Limited

DRAWN:

2011-07-11

CHECKED:

2011-07-11

APPROVED:

2011-07-11

Revision History:

LCM NO: AMG12864P-G

Rev: 00

UNITS: mm

DWG NO: AMG12864P-G

SHEET 2 OF 2

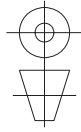

CUSTOMER APPROVAL:

3 I/O Terminal

3.1 Pin Description

Pin NO.	Symbol	Function Description
1	VSS	Ground
2	VDD	Power supply.
3	NC	Not connect
4	/RES	When /RES is set to "L," the settings are initialized. The reset operation is performed by the /RES signal level.
5	/CS1	This is the chip select signal.
6	RS	This is connect to the least significant bit of the normal and it determines whether the data bits are data or a RS = "H": Indicates that D0 to D7 are display data. RS = "L": Indicates that D0 to D7 are control data.
7	R/W	<ul style="list-style-type: none"> When connected to an 8080 MPU, this is active LOW. (R/W) This terminal connects to the 8080 MPU /WR signal. The signals on the data bus are latched at the rising edge of the /WR signal. When connected to a 6800 Series MPU: This is the read/write control signal input terminal. When R/W = "H": Read. When R/W = "L": Write.
8	E	<ul style="list-style-type: none"> When connected to a 6800 Series MPU, this is active HIGH. This is the 6800 Series MPU enable clock input terminal.
9~16	D0~D7	This is an 8-bit bi-directional data bus that connects to an 8-bit or 16-bit standard MPU data bus.
17	C86	This is the MPU interface switch terminal. C86 = "H": 6800 Series MPU interface. C86 = "L": 8080 MPU interface.
18	P/S	This is the parallel data input/serial data input switch terminal. P/S = "H": Parallel data input. P/S = "L": Serial data input. The following applies depending on the P/S status: When P/S = "L", D0 to D5 fixed "H". /RD (E) and /WR (R/W) are fixed to either "H" or "L". With serial data input, It is impossible read data from RAM . P/S Data/Command Data Read/Write Serial Clock "H" A0 D0 to D7 /RD, /WR X "L" A0 SI (D7) Write only SCL (D6)
19	LED+	+5V
20	LED-	Ground

3.2 Block Diagram and Application Circuit

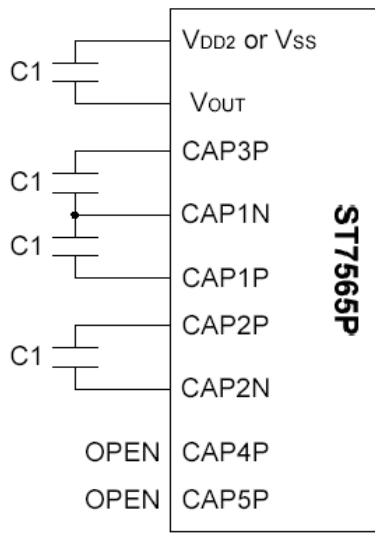

4x voltage booster circuit

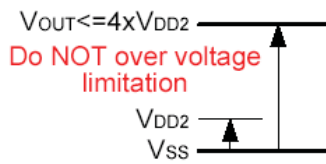

4x boost voltage relationship

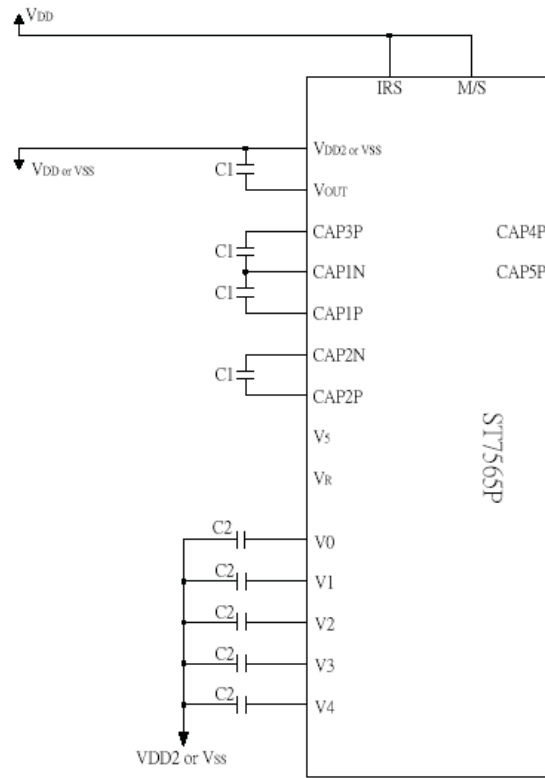

4 Electro-optical Specifications

4.1 Absolute Maximum Ratings

No	Item	Symbol	Min.	Max.	Unit
1	Supply Voltage For Logic	$V_{DD} - V_{SS}$	0.3	3.6	V
2	Supply Voltage For LCD Driver	V_{LCD}	0.3	14.5	V
3	Input Voltage	V_{IN}	0.3	3.6	V

Note: Operating Temperature and Storage Temperature can be found in 1. *General Specifications*.

4.2 Optical Characteristics⁽¹⁾

No	Item	Symbol	Condition	Min.	Typ.	Max.	Unit
1	Contrast Ratio	Cr	$T_a = 23 \pm 3^\circ\text{C}$ $V_{LCD} = \text{Typ.}^{(2)}$	8.4	9.08	-	-
2	Response time	T_{ON}	$T_a = 23 \pm 3^\circ\text{C}$	-	223	330	ms
3	Response time	T_{OFF}	$T_a = 23 \pm 3^\circ\text{C}$	-	102	200	ms
4	Viewing Angle	3H	$Cr = 2$ $T_a = 23 \pm 3^\circ\text{C}$	43	48	-	Deg.
5		9H		45	49	-	Deg.
6		6H		39	44	-	Deg.
7		12H		26	31	-	Deg.

Note:

(1) See Appendix Definition of Optical Characteristics for detail.

(2) V_{LCD} can be found in 4.2 Electrical Characteristics *Supply Voltage for LCD Driver*

4.3 Electrical Characteristics

No	Item	Symbol	Condition	Min.	Typ.	Max.	Unit
1	Supply Voltage for Logic	$V_{DD} - V_{SS}$	-	2.9	3.0	3.1	V
2	Supply Voltage for LCD Driver	V_{LCD}	$T_a = 25^\circ\text{C}$	10.1	10.3	10.5	V
3	Supply Current for Logic	I_{DD}	-....	-	-	1.0	mA
4	Frame Frequency	f_M	$T_a = 25^\circ\text{C}$	17	20	24	KHz

5	Input High Voltage	V_{IH}	-	$0.8 V_{DD}$	-	V_{DD}	V
6	Input Low Voltage	V_{IL}	-	VSS	-	$0.2 V_{DD}$	V
7	Output High Voltage	V_{OH}	-	$0.8 V_{DD}$	-	V_{DD}	V
8	Output Low Voltage	V_{OL}	-	VSS	-	$0.2 V_{DD}$	V

9	Supply Current for LED Backlight	I_{LED}	$V_{LED} = \text{Typ.}$ $T_a = 23 \pm 3^\circ\text{C}$	-	45	-	mA
10	Supply Voltage for LED Backlight	V_{LED}	$I_{LED} = \text{Typ.}$ $T_a = 23 \pm 3^\circ\text{C}$	4.8	5.0	5.2	V

4.4 Timing Characteristics

System Bus Read/Write Characteristics 1 (For the 8080 Series MPU)

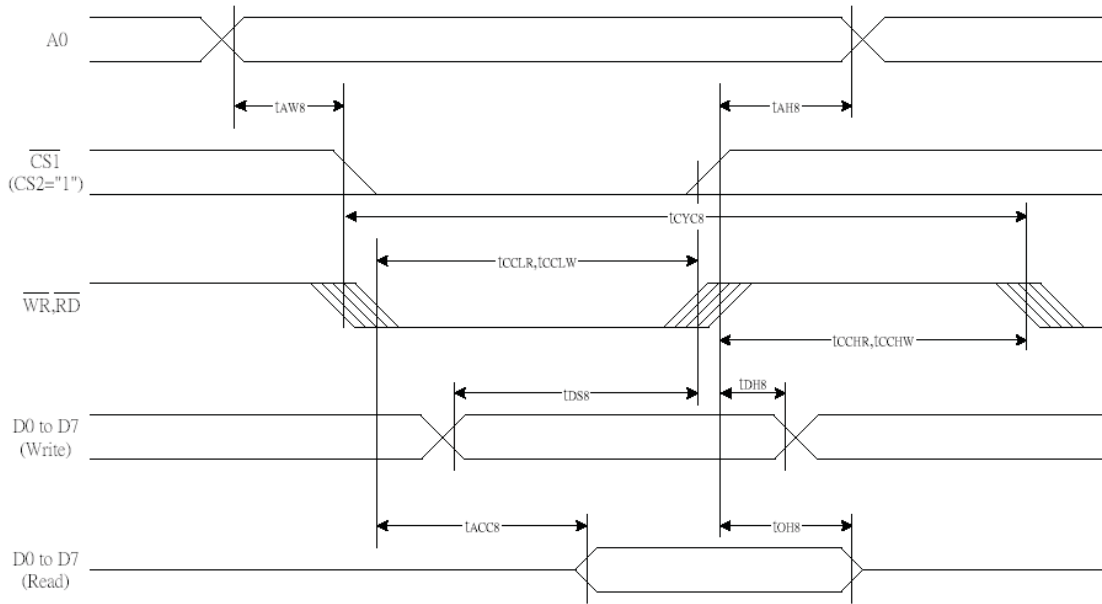

Figure 37

Table 24

($V_{DD} = 3.3V$, $T_a = -30$ to $85^{\circ}C$)

Item	Signal	Symbol	Condition	Rating		Units
				Min.	Max.	
Address hold time	A0	tAH8		0	—	Ns
Address setup time		tAW8		0	—	
System cycle time		tCYC8		240	—	
Enable L pulse width (WRITE)	WR	tCCLW		80	—	
Enable H pulse width (WRITE)		tCCHW		80	—	
Enable L pulse width (READ)	RD	tCCLR		140	—	
Enable H pulse width (READ)		tCCHR		80	—	
WRITE Data setup time	D0 to D7	tDS8		40	—	
WRITE Address hold time		tDH8		0	—	
READ access time		tACC8	$C_L = 100 \text{ pF}$	—	70	
READ Output disable time		tOH8	$C_L = 100 \text{ pF}$	5	50	

(V_{DD} = 2.7V, Ta = -30 to 85°C)

Item	Signal	Symbol	Condition	Rating		Units
				Min.	Max.	
Address hold time	A0	t _{AH8}		0	—	ns
Address setup time		t _{AW8}		0	—	
System cycle time		t _{CYC8}		400	—	
Enable L pulse width (WRITE)	WR	t _{CCLW}		220	—	
Enable H pulse width (WRITE)		t _{CCHW}		180	—	
Enable L pulse width (READ)	RD	t _{CCLR}		220	—	
Enable H pulse width (READ)		t _{CCHR}		180	—	
WRITE Data setup time	D0 to D7	t _{DS8}		40	—	
WRITE Address hold time		t _{DH8}		0	—	
READ access time		t _{ACC8}	CL = 100 pF	—	140	
READ Output disable time		t _{OH8}	CL = 100 pF	10	100	

Table 26

(V_{DD} = 1.8V, Ta = -30 to 85°C)

Item	Signal	Symbol	Condition	Rating		Units
				Min.	Max.	
Address hold time	A0	t _{AH8}		0	—	ns
Address setup time		t _{AW8}		0	—	
System cycle time		t _{CYC8}		640	—	
Enable L pulse width (WRITE)	WR	t _{CCLW}		360	—	
Enable H pulse width (WRITE)		t _{CCHW}		280	—	
Enable L pulse width (READ)	RD	t _{CCLR}		360	—	
Enable H pulse width (READ)		t _{CCHR}		280	—	
WRITE Data setup time	D0 to D7	t _{DS8}		80	—	
WRITE Address hold time		t _{DH8}		0	—	
READ access time		t _{ACC8}	CL = 100 pF	—	240	
READ Output disable time		t _{OH8}	CL = 100 pF	10	200	

*1 The input signal rise time and fall time (t_r, t_f) is specified at 15 ns or less. When the system cycle time is extremely fast, (t_r + t_f) ≤ (t_{CYC8} - t_{CCLW} - t_{CCHW}) for (t_r + t_f) ≤ (t_{CYC8} - t_{CCLR} - t_{CCHR}) are specified.

*2 All timing is specified using 20% and 80% of V_{DD} as the reference.

*3 t_{CCLW} and t_{CCLR} are specified as the overlap between /CS1 being "L" (CS2 = "H") and /WR and /RD being at the "L" level.

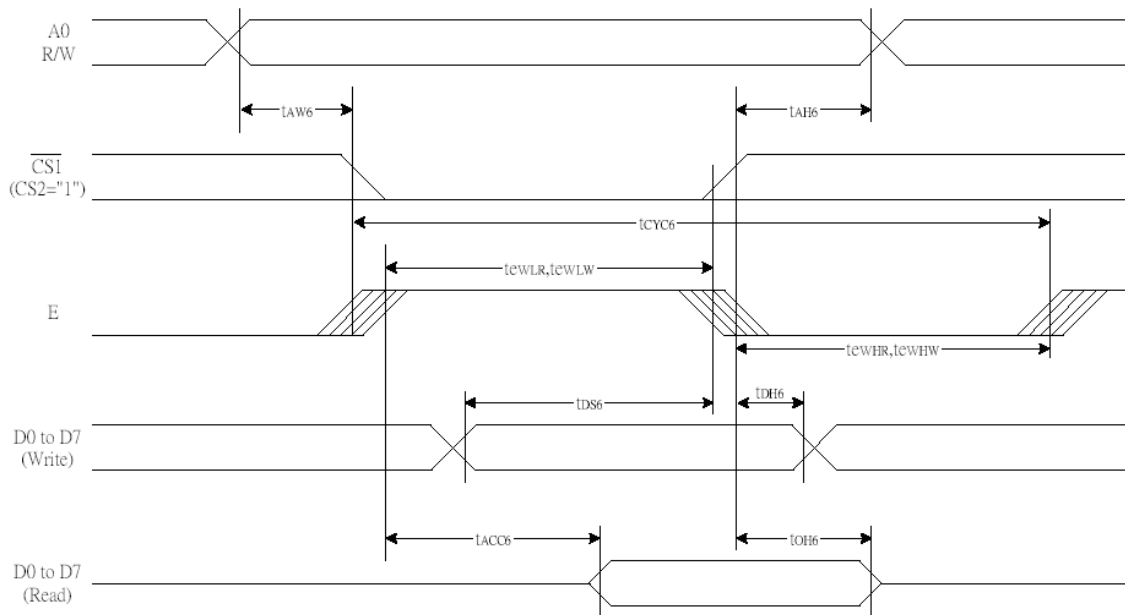

System Bus Read/Write Characteristics 2 (For the 6800 Series MPU)

Figure 38

Table 27

(V_{DD} = 3.3V, T_a = -30 to 85°C)

Item	Signal	Symbol	Condition	Rating		Units
				Min.	Max.	
Address hold time	A0	t _{AH6}		0	—	ns
Address setup time		t _{AW6}		0	—	
System cycle time		t _{CYC6}		240	—	
Enable L pulse width (WRITE)	WR	t _{EWLW}		80	—	
Enable H pulse width (WRITE)		t _{EWHW}		80	—	
Enable L pulse width (READ)	RD	t _{EWL}		80	—	
Enable H pulse width (READ)		t _{EWH}		140	—	
WRITE Data setup time	D0 to D7	t _{DS6}		40	—	
WRITE Address hold time		t _{DH6}		0	—	
READ access time		t _{ACC6}	CL = 100 pF	—	70	
READ Output disable time		t _{OH6}	CL = 100 pF	5	50	

(V_{DD} = 2.7V, T_a = -30 to 85°C)

Item	Signal	Symbol	Condition	Rating		Units
				Min.	Max.	
Address hold time	A0	t _{AH6}		0	—	ns
Address setup time		t _{AW6}		0	—	
System cycle time		t _{CYC6}		400	—	
Enable L pulse width (WRITE)	WR	t _{EWLW}		220	—	
Enable H pulse width (WRITE)		t _{EWHW}		180	—	
Enable L pulse width (READ)	RD	t _{EWLR}		220	—	
Enable H pulse width (READ)		t _{EWHR}		180	—	
WRITE Data setup time	D0 to D7	t _{DS6}		40	—	
WRITE Address hold time		t _{DH6}		0	—	
READ access time		t _{ACC6}	CL = 100 pF	—	140	
READ Output disable time		t _{OH6}	CL = 100 pF	10	100	

Table 29

(V_{DD} = 1.8V, T_a = -30 to 85°C)

Item	Signal	Symbol	Condition	Rating		Units
				Min.	Max.	
Address hold time	A0	t _{AH6}		0	—	ns
Address setup time		t _{AW6}		0	—	
System cycle time		t _{CYC6}		640	—	
Enable L pulse width (WRITE)	WR	t _{EWLW}		360	—	
Enable H pulse width (WRITE)		t _{EWHW}		280	—	
Enable L pulse width (READ)	RD	t _{EWLR}		360	—	
Enable H pulse width (READ)		t _{EWHR}		280	—	
WRITE Data setup time	D0 to D7	t _{DS6}		80	—	
WRITE Address hold time		t _{DH6}		0	—	
READ access time		t _{ACC6}	CL = 100 pF	—	240	
READ Output disable time		t _{OH6}	CL = 100 pF	10	200	

*1 The input signal rise time and fall time (t_r, t_f) is specified at 15 ns or less. When the system cycle time is extremely fast, (t_r + t_f) ≤ (t_{CYC6} - t_{EWLW} - t_{EWHW}) for (t_r + t_f) ≤ (t_{CYC6} - t_{EWLR} - t_{EWHR}) are specified.

*2 All timing is specified using 20% and 80% of V_{DD} as the reference.

*3 t_{EWLW} and t_{EWLR} are specified as the overlap between $\overline{CS1}$ being "L" (CS2 = "H") and E.

The Serial Interface

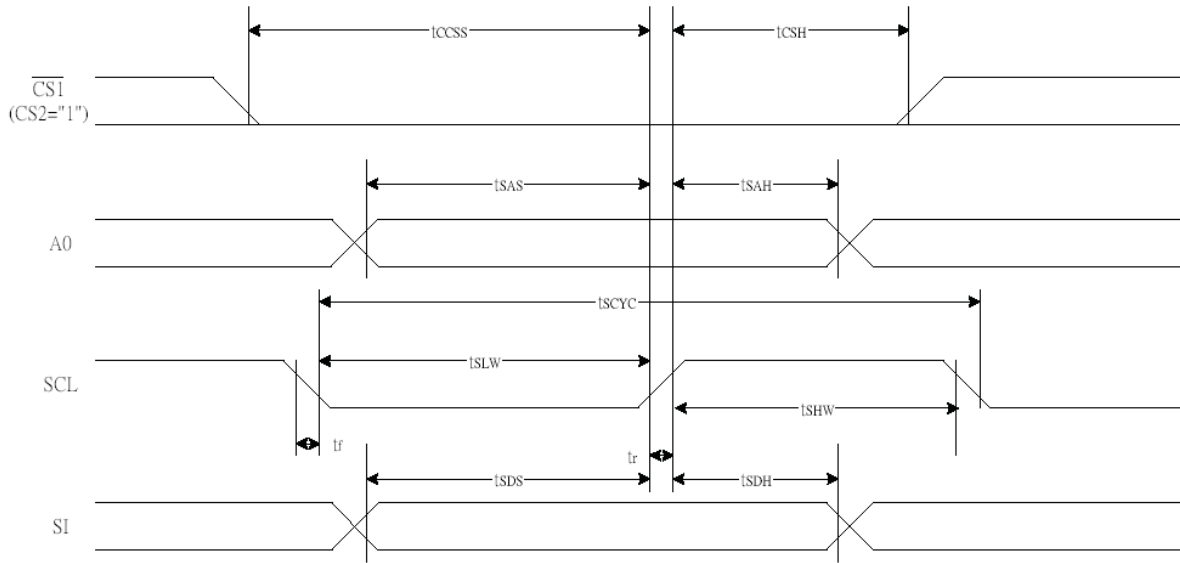

Figure 39

Table 30

(V_{DD} = 3.3V, T_a = -30 to 85°C)

Item	Signal	Symbol	Condition	Rating		Units
				Min.	Max.	
Serial Clock Period	SCL	T _{scyc}		50	—	ns
SCL "H" pulse width		T _{shw}		25	—	
SCL "L" pulse width		T _{slw}		25	—	
Address setup time	A0	T _{sas}		20	—	
Address hold time		T _{sah}		10	—	
Data setup time	SI	T _{sds}		20	—	
Data hold time		T _{sdh}		10	—	
CS-SCL time	CS	T _{css}		20	—	
CS-SCL time		T _{csh}		40	—	

Table 31

(V_{DD} = 2.7V, T_a = -30 to 85°C)

Item	Signal	Symbol	Condition	Rating		Units
				Min.	Max.	
Serial Clock Period	SCL	T _{scyc}		100	—	ns
SCL "H" pulse width		T _{shw}		50	—	
SCL "L" pulse width		T _{slw}		50	—	
Address setup time	A0	T _{sas}		30	—	
Address hold time		T _{sah}		20	—	
Data setup time	SI	T _{sds}		30	—	
Data hold time		T _{sdh}		20	—	
CS-SCL time	CS	T _{css}		30	—	
CS-SCL time		T _{csh}		60	—	

(V_{DD} = 1.8V, T_a = -30 to 85°C)

Item	Signal	Symbol	Condition	Rating		Units
				Min.	Max.	
Serial Clock Period	SCL	T _{SCYC}		200	—	ns
SCL "H" pulse width		T _{SHW}		80	—	
SCL "L" pulse width		T _{SLW}		80	—	
Address setup time	A0	T _{SAS}		60	—	
Address hold time		T _{SAH}		30	—	
Data setup time	SI	T _{SDS}		60	—	
Data hold time		T _{SDH}		30	—	
CS-SCL time	CS	T _{CSS}		40	—	
CS-SCL time		T _{CSH}		100	—	

*1 The input signal rise and fall time (t_r, t_f) are specified at 15 ns or less.

*2 All timing is specified using 20% and 80% of V_{DD} as the standard.

5 Programming

5.1 Instruction Table

Command	Command Code										Function		
	A0	/RD	/WR	D7	D6	D5	D4	D3	D2	D1		D0	
(1) Display ON/OFF	0	1	0	1	0	1	0	1	1	1	0	1	LCD display ON/OFF 0: OFF, 1: ON
(2) Display start line set	0	1	0	0	1	Display start address						Sets the display RAM display start line address	
(3) Page address set	0	1	0	1	0	1	1	Page address				Sets the display RAM page address	
(4) Column address set upper bit	0	1	0	0	0	0	1	Most significant column address				Sets the most significant 4 bits of the display RAM column address.	
Column address set lower bit	0	1	0	0	0	0	0	Least significant column address				Sets the least significant 4 bits of the display RAM column address.	
(5) Status read	0	0	1	Status				0	0	0	0	0	Reads the status data
(6) Display data write	1	1	0	Write data								Writes to the display RAM	
(7) Display data read	1	0	1	Read data								Reads from the display RAM	
(8) ADC select	0	1	0	1	0	1	0	0	0	0	0	1	Sets the display RAM address SEG output correspondence 0: normal, 1: reverse
(9) Display normal/reverse	0	1	0	1	0	1	0	0	1	1	0	1	Sets the LCD display normal/reverse 0: normal, 1: reverse
(10) Display all points ON/OFF	0	1	0	1	0	1	0	0	1	0	0	1	Display all points 0: normal display 1: all points ON
(11) LCD bias set	0	1	0	1	0	1	0	0	0	1	0	1	Sets the LCD drive voltage bias ratio 0: 1/9 bias, 1: 1/7 bias (ST7565P)
(12) Read/modify/write	0	1	0	1	1	1	0	0	0	0	0	0	Column address increment At write: +1 At read: 0
(13) End	0	1	0	1	1	1	0	1	1	1	0	0	Clear read/modify/write
(14) Reset	0	1	0	1	1	1	0	0	0	1	0	0	Internal reset
(15) Common output mode select	0	1	0	1	1	0	0	0	*	*	*	1	Select COM output scan direction 0: normal direction 1: reverse direction
(16) Power control set	0	1	0	0	0	1	0	1	Operating mode			Select internal power supply operating mode	
(17) Vo voltage regulator internal resistor ratio set	0	1	0	0	0	1	0	0	Resistor ratio			Select internal resistor ratio(Rb/Ra) mode	
(18) Electronic volume mode set	0	1	0	1	0	0	0	0	0	0	0	1	Set the Vo output voltage electronic volume register
Electronic volume register set				0	0	Electronic volume value							
(19) Static indicator ON/OFF	0	1	0	1	0	1	0	1	1	0	0	1	0: OFF, 1: ON
Static indicator register set				0	0	0	0	0	0	0	0	0	Mode
(20) Booster ratio set	0	1	0	1	1	1	1	1	0	0	0	0	select booster ratio 00: 2x,3x,4x 01: 5x 11: 6x
(21) Power saver													Display OFF and display all points ON compound command
(22) NOP	0	1	0	1	1	1	0	0	0	1	1	1	Command for non-operation
(23) Test	0	1	0	1	1	1	1	*	*	*	*	*	Command for IC test. Do not use this command

5.2 Display Data RAM

Relationship between display pattern and Display Data RAM show as below:

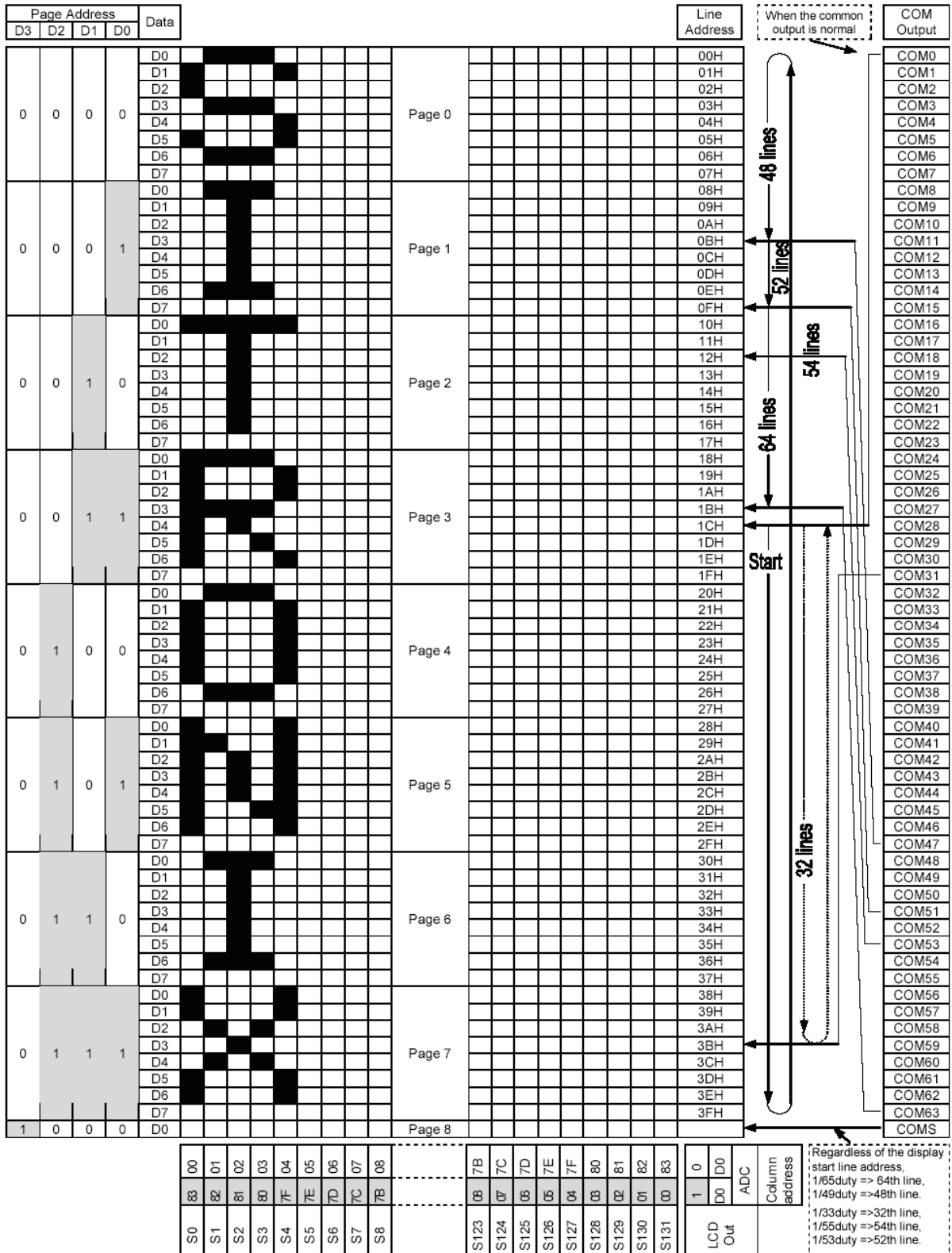

Appendix

1 Packing Method

Method 1

ESD Bag + Product Box + Plastic Bag + Carton

4. Packing Method

1. Quantity

QUANTITY	UNIT
1	PCS / ESD Bag
108	PCS / Box
2	Box / Carton
216	PCS / Carton

2. Material

Material	Size (LXWXH) mm
ESD Bag	
Product Box	
Carton	

3. Label

PRODUCT ID:
PART NO:
QUANTITY:
GROSS WEIGHT:
MEASUREMENTS:

Note: see table 1. Quantity for detail.

Method 2

ESD Tray + Plastic Bag + Carton

4. Packing Method

1. Quantity

QUANTITY	UNIT
	PCS / Tray
	Tray / Carton
	PCS / Carton

2. Material

Material	Size (LXWXH) mm
ESD Tray	
Carton	

3. Label

PRODUCT ID:
PART NO:
QUANTITY:
GROSS WEIGHT:
MEASUREMENTS:

Note: see table 1. Quantity for detail.

Note:

2 Definitions of Optical Characteristic

2.1 Contrast Ratio Test

A) Contrast ratio is calculated by the following formula when the output voltage is obtained from the electro-optical test system.

B) Test Condition: Accord to the LCD's driving method and operating voltage (V_{LCD}).

C) Formula:

$$\text{Contrast Ratio (Positive type)} = \frac{\text{Photometer output voltage when non-select waveform is applying}}{\text{Photometer output voltage when select waveform is applying}}$$

$$\text{Contrast Ratio (Negative type)} = \frac{\text{Photometer output voltage when select waveform is applying}}{\text{Photometer output voltage when non-select waveform is applying}}$$

D) Test system:

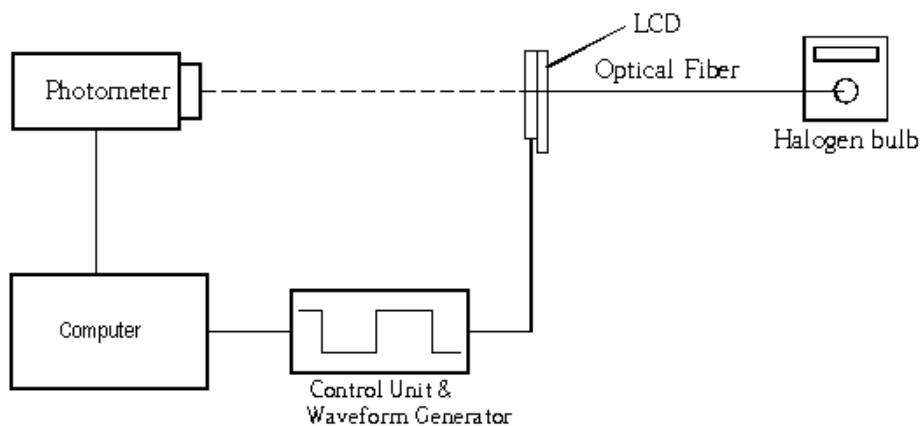

2.2 Response time

2.2.1 Positive type

- A) Rise time is defined as the time required for the transmission to change from 90% to 10%.
- B) Fall time is defined as the time required for the transmission to change from 10% to 90%.
- C) On time is defined as the time required for the transmission to change from 100% to 10%.
- D) Off time is defined as the time required for the transmission to change from 0% to 90%.

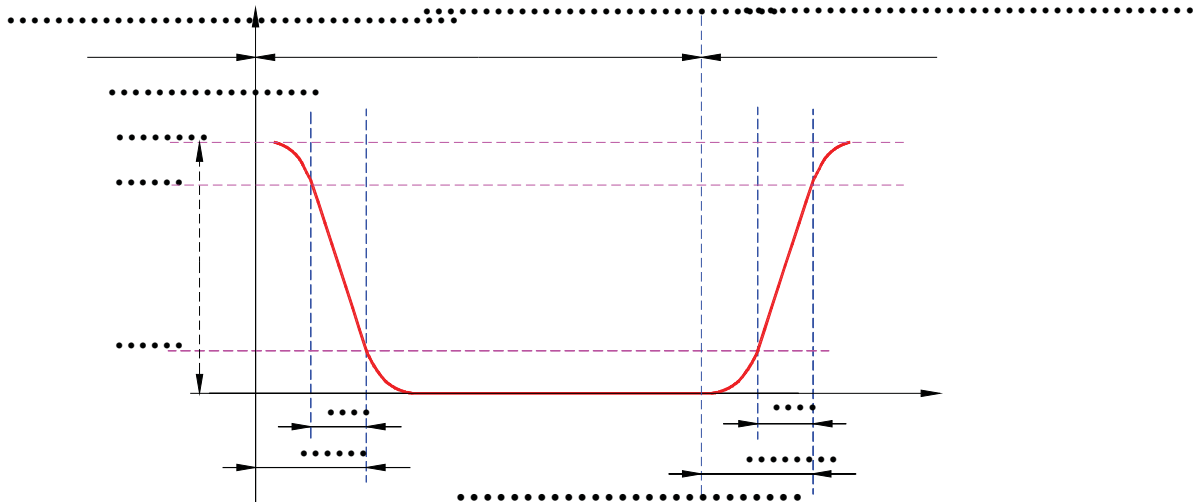

2.2.1 Negative type

- A) Rise time is defined as the time required for the transmission to change from 10% to 90%.
- B) Fall time is defined as the time required for the transmission to change from 90% to 10%.
- C) On time is defined as the time required for the transmission to change from 0% to 90%.
- D) Off time is defined as the time required for the transmission to change from 100% to 10%.

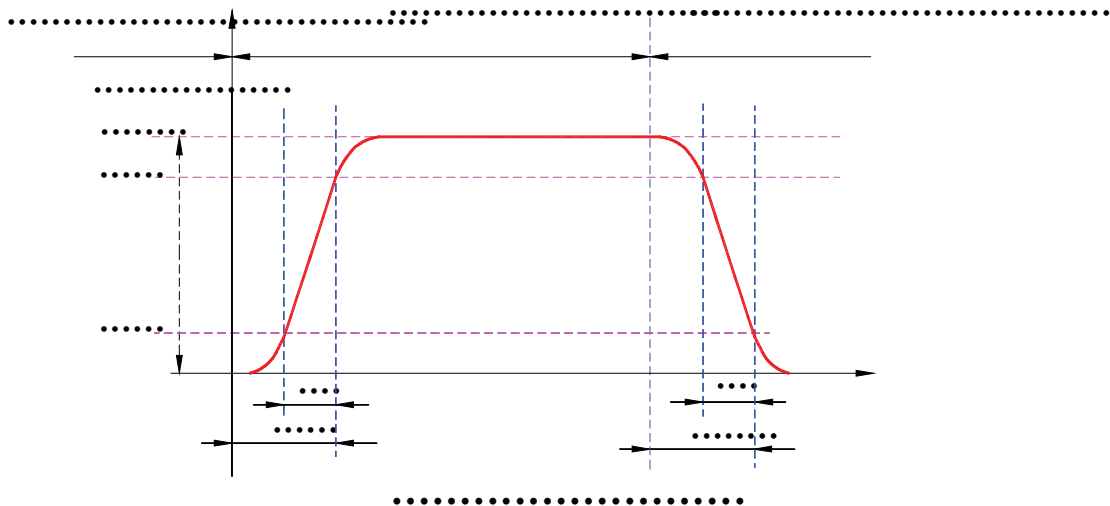

2.3 Viewing Angle

A) Viewing angle is definition

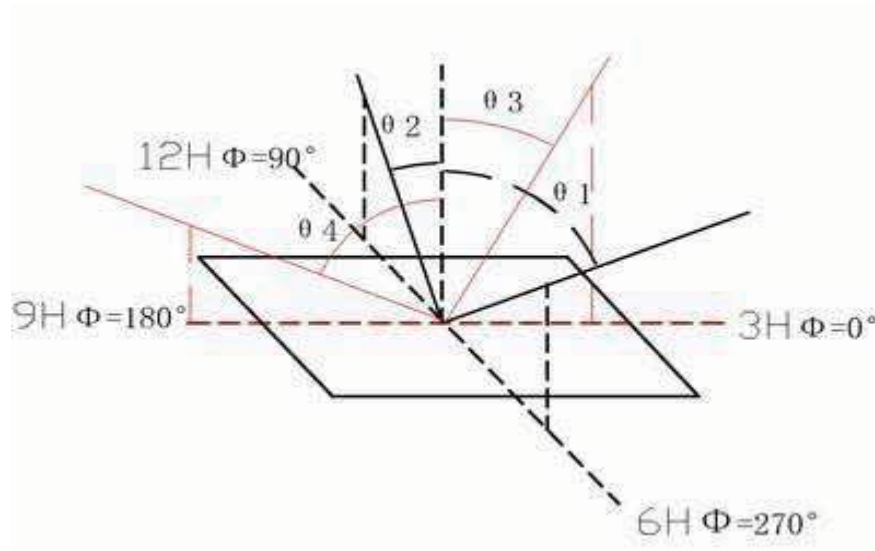

B) System Block Diagram

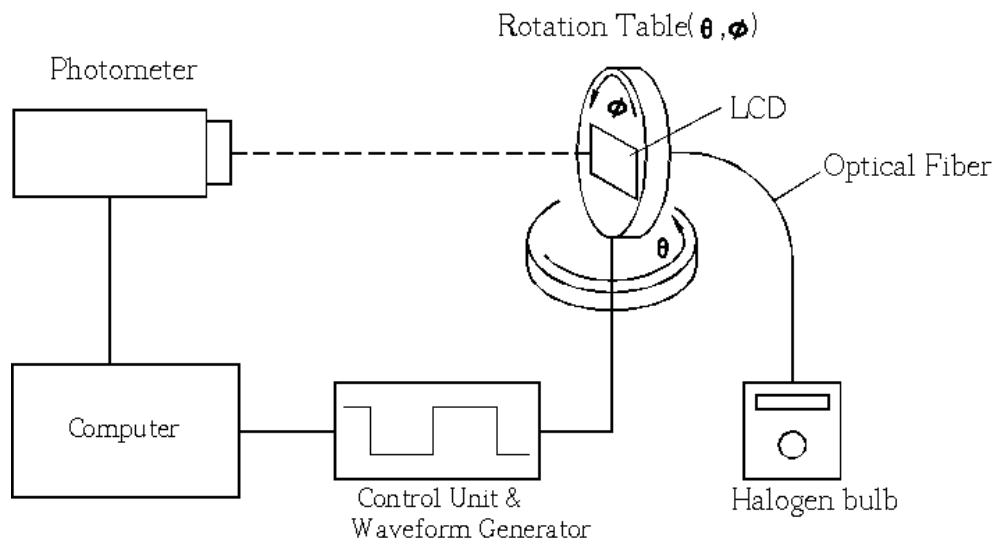

3 Quality Units

3.1 Visual and Technological Inspection

- Visual inspection must be performed with naked eye on display.
 - Distance between observer and display should be about 30 cm.
 - Perform inspection at OFF state and ON state
 - Ambient lighting should be 1000 lux
 - Transmissive, transfective and negative type specimens should be inspected in backlight
- (i) Inspecting method:

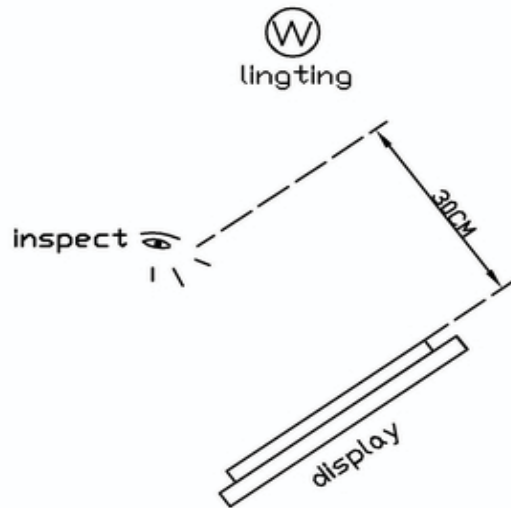

(ii) Definition of area:

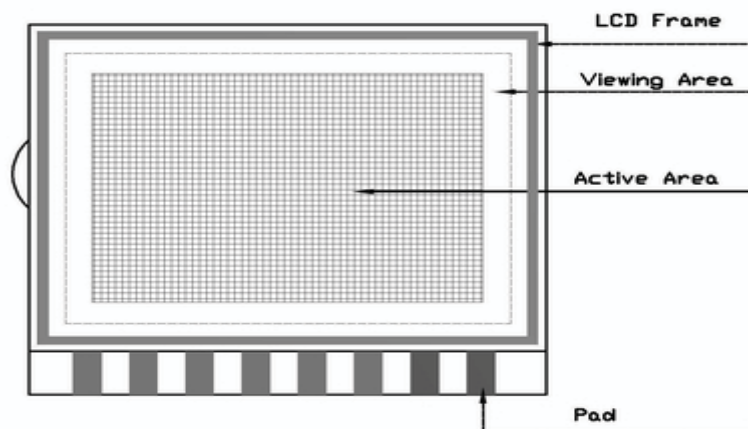

Note: The drawing is a general sketch map only. If want to see the product outline detail, please see the product outline drawing.

3.2 Visual Inspection Standard:

Table1

(Unit: mm)

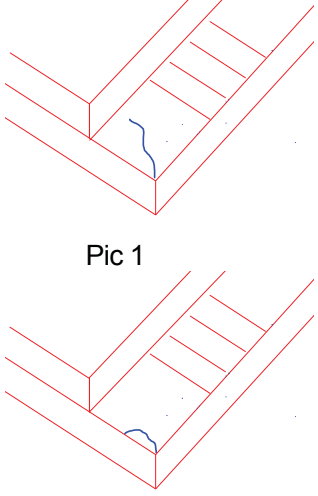
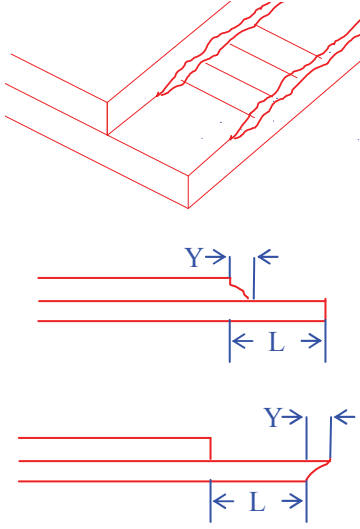
No	Defect Item			Criterion	
	Defect describe	Position	classify	Section	Acceptable Number(N)(*3)
1	Liquid Crystal Leakage				Not acceptable
2	Bubble in Liquid Crystal				Not acceptable
3	Rainbow		Slight *1		Acceptable
			Obvious *2		Not acceptable
4	ITO Glass Crackle 		Slight	Pic 1: Enter into the glass	Not acceptable
			Slight	Pic 2: not Enter into the glass	2
5 *4	ITO Glass Protrusion: 		Slight	1 smaller glass edge: Y \leq t/6, X ignore, Z \leq t 2: larger glass edge: no influence upon no influence upon outline dimension assemble, display function	1
6 *4	Chipped Glass:	pad Edge	Slight	X \leq 1.5, Y \leq 1/3L, Z \leq t or chip don't touch one third of Pad width.	2

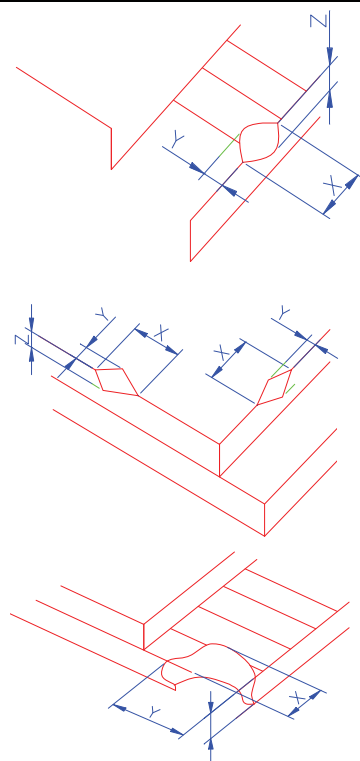
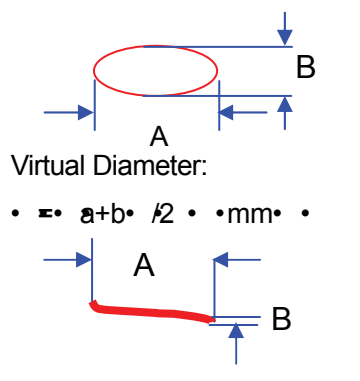
		Non-Pad Edge	Slight	$X \leq 2, Y \leq 1, Z \leq t, Y$ can't enter into active area and can't touch the sealant	2
		Corner	Slight	$X \leq 1.5, Y \leq 1.5, Z \leq t$	2
7	Black/White Spots (Include LCD and Backlight):  Virtual Diameter: $\phi = (a+b) / 2 \text{ mm}$	Circular Type	Slight	$\phi \leq 0.1$	Acceptable
				$0.10 < \phi \leq 0.2$	2
				$0.2 < \phi \leq 0.25$	1
		Linear Type	Slight	$B \leq 0.05 \quad A \leq 2$	Acceptable
				$0.05 < B \leq 0.1 \quad A \leq 2$	2
$B > 0.1$	According to the spot's standard				
8	Polarizer Bubble			$\phi \leq 0.2$	Acceptable
				$0.2 < \phi \leq 0.3$	2
				$0.3 < \phi \leq 0.5$	1
Note	1. Slight rainbow: rainbow outside of Viewing Area, or concolorous rainbow inside of ViewingArea but don't go beyond the limited sample which affirmed by purchaser. 2. Obvious rainbow: double color rainbow in Viewing area and go beyond the limited sample which affirmed by purchaser. 3. Acceptable Number(N) is the defects number in the LCD that will be defined according to the defects distributing density. In this table,the acceptable number is $\leq 1/1(\text{cm})^2$. If purchaser has different suggest, please discuss with GW.				

3.3 Display Inspection Standard:

Table2

(Unit: mm)

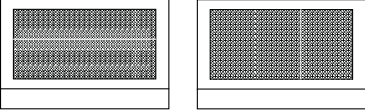
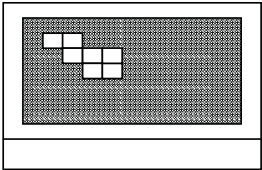
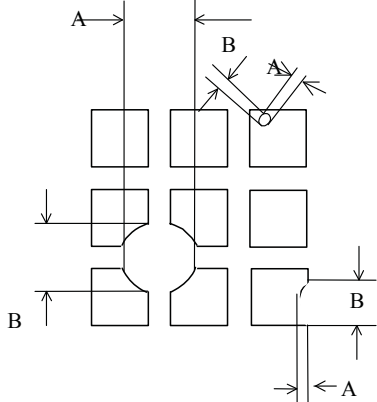
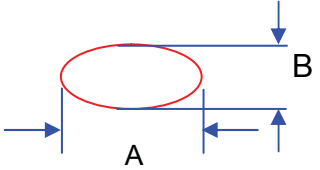
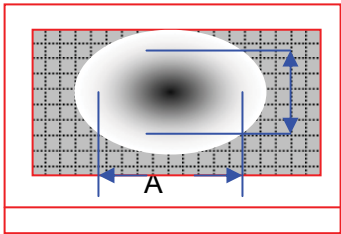
No	Defect Item	Criterion	
		Section	Acceptable Number(N) (*1)
1	Non display		Not acceptable
2	Display missing 		Not acceptable
3	Short Circuit		Not acceptable
4	Abnormal display 		Not acceptable
5	Pin Hole & Gap in displaying segment or Dot Matrix:  Virtual Diameter: • $\bar{a} = \frac{a+b}{2}$ • mm •	• • $\bar{0.1}$	Acceptable
		0.1 • • • $\bar{0.2}$ •	2
		0.2 • • • $\bar{0.25}$ •	1
		• $\bar{>0.25}$	Not acceptable
6	Display Black/White Spots   • $\bar{a} = \frac{A+B}{2}$ mm	The spot's dimension and color don't alter with the voltage alteration	
		• • $\bar{0.10}$	acceptable
		0.10 < • • $\bar{0.2}$	3
		0.2 < • • $\bar{0.25}$	1
		• $\bar{>0.25}$	Not acceptable
		The spot's dimension and color alter with the voltage alteration	
		• • $\bar{0.3}$	acceptable
		0.3 < • • $\bar{0.5}$	3
0.5 < • • $\bar{0.8}$	1		
• $\bar{>0.8}$	Not acceptable		
7	Display Black/White lines	The Line's dimension and color don't alter with the voltage alteration	
		B • $\bar{0.05}$ A • $\bar{2}$	acceptable
		0.05 < B • $\bar{0.1}$ A • $\bar{2}$	3
	B > 0.1	According to the spot's standard	

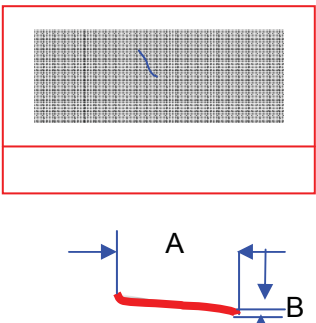
		The Line's dimension and color alter with the voltage alteration	
		$B \cdot 0.07 \quad A \cdot 5$	acceptable
		$0.07 < B \cdot 0.15 \quad A \cdot 5$	3
		$0.15 < B \cdot 0.3 \quad A \cdot 5$	1
		$B > 0.3$	According to the spot's standard
8	The current overflow		Not acceptable
Note	1. when the width value of Segment or Dot Matrix is less than 3.0 mm, no default is acceptable 2. No more than 5 defaults are acceptable in 1cm^2 area.		

4 Reliability-TEST

4.1. Standard Specifications for Reliability

4.1-1 Test method

There should be no existing conspicuous failure of functions and appearance in LCD after the following tests.

NO	Item	Description
1	Low Temperature Operating	The sample should be allowed to stand at $(-20 \pm 2)^\circ\text{C}$ for 96 Hours under driving condition.
2	High Temperature Operating	The sample should be allowed to stand at $(+70 \pm 2)^\circ\text{C}$ for 96 Hours under driving condition.
3	Low Temperature Storage	The sample should be allowed to stand at $(-30 \pm 3)^\circ\text{C}$ for 96 Hours under no-load condition, and then returning it to normal temperature condition, and allowing it stand for 24 hours
4	High Temperature Storage	The sample should be allowed to stand at $(+80 \pm 2)^\circ\text{C}$ for 96Hours under no-load condition, and then returning it to normal temperature condition, and allowing it stand for 24 hours
5	Moisture resistance	The sample should be allowed to stand at $(40 \pm 2)^\circ\text{C}$; $(95 \pm 2)\% \text{RH}$ for 96Hours under no-load condition excluding the polarizer, then taking it out and drying it at normal temperature, and allowing it stand for 24 hours
6	Thermal Shock Resistance	The sample should be allowed to stand the following 5 cycles of operation: T_{STL}^* for 30 minutes \rightarrow normal temperature for 5 minutes $\rightarrow T_{\text{STH}}^*$ for 30 minutes \rightarrow normal temperature for 5 minutes, as one cycle, then taking it out and drying it at normal temperature, and allowing it stand for 24 hours

Note:

T_{STL} : Lowest Storage Operation Temperature.

T_{STH} : Lowest Storage Temperature.

4.1-2 Testing Conditions and Inspection Criteria:

For the final test, the testing sample must be stored at room temperature for 24 hours, after the tests listed above; Standard specifications for Reliability have been executed in order to ensure stability.

NO	Item	Inspection Criteria
1	Current Consumption	The current consumption should be under double of initial test.
2	Contrast	The contrast must be larger than half of initial test.
3	Appearance	Appearance defects should not happen.

4.2 Life Time:

Functions, performance, appearance, etc. shall be free from remarkable deterioration within 50,000 hours under ordinary operating and storage conditions room temperature ($25\pm 10^{\circ}\text{C}$), normal humidity ($45\pm 20\%\text{RH}$), and in area not exposed to direct sunlight.