



FocusLCDs.com
LCDs MADE SIMPLE®

Ph. 480-503-4295 | NOPP@FocusLCD.com

TFT | CHARACTER | UWVD | FSC | SEGMENT | CUSTOM | REPLACEMENT

Graphic Display Module

Part Number

G126CLGFGLW6WTCCXAL

Overview

128x64(77.4x52.4), FSTN, Gray
background, White LED, Bottom view,
Wide temp, Transflective (positive),
3.0V LCD, 3.0V LED,
Controller=ST7565R, RoHS Compliant

1. Features

1. 128*64 dots
2. 80 or 68 MPU interfaces
3. Built-in controller (ST7565R)
4. Display Mode & Backlight Variations
5. ROHS Compliant

LCD type	<input type="checkbox"/> TN			
	<input checked="" type="checkbox"/> FSTN	<input type="checkbox"/> FSTN Negative		
	<input type="checkbox"/> STN Yellow Green	<input type="checkbox"/> STN Gray	<input type="checkbox"/> STN Blue Negative	
View direction	<input checked="" type="checkbox"/> 6 O'clock		<input type="checkbox"/> 12 O'clock	
Rear Polarizer	<input type="checkbox"/> Reflective		<input checked="" type="checkbox"/> Transflective	<input type="checkbox"/> Transmissive
Backlight Type	<input checked="" type="checkbox"/> LED	<input type="checkbox"/> EL	<input type="checkbox"/> Internal Power	<input checked="" type="checkbox"/> 3.0V Input
		<input type="checkbox"/> CCFL	<input checked="" type="checkbox"/> External Power	<input type="checkbox"/> 5.0V Input
Backlight Color	<input checked="" type="checkbox"/> White	<input type="checkbox"/> Blue	<input type="checkbox"/> Amber	<input type="checkbox"/> Yellow-Green
Temperature Range	<input type="checkbox"/> Normal		<input checked="" type="checkbox"/> Wide	<input type="checkbox"/> Super Wide
DC to DC circuit	<input checked="" type="checkbox"/> Build-in			<input type="checkbox"/> Not Build-in
Touch screen	<input type="checkbox"/> With			<input checked="" type="checkbox"/> Without
Font type	<input type="checkbox"/> English-Japanese	<input type="checkbox"/> English-European	<input type="checkbox"/> English-Russian	<input checked="" type="checkbox"/> Other

2. MECHANICAL SPECIFICATIONS

Module size	77.4mm(L)*52.4mm(W)* 10.7mm(H)
Viewing area	70.0mm(L)*40.0mm(W)
Dots size	0.48mm(L)*0.48mm(W)
Dots pitch	0.52mm(L)*0.52mm(W)
Weight	Approx.

3. Outline dimension

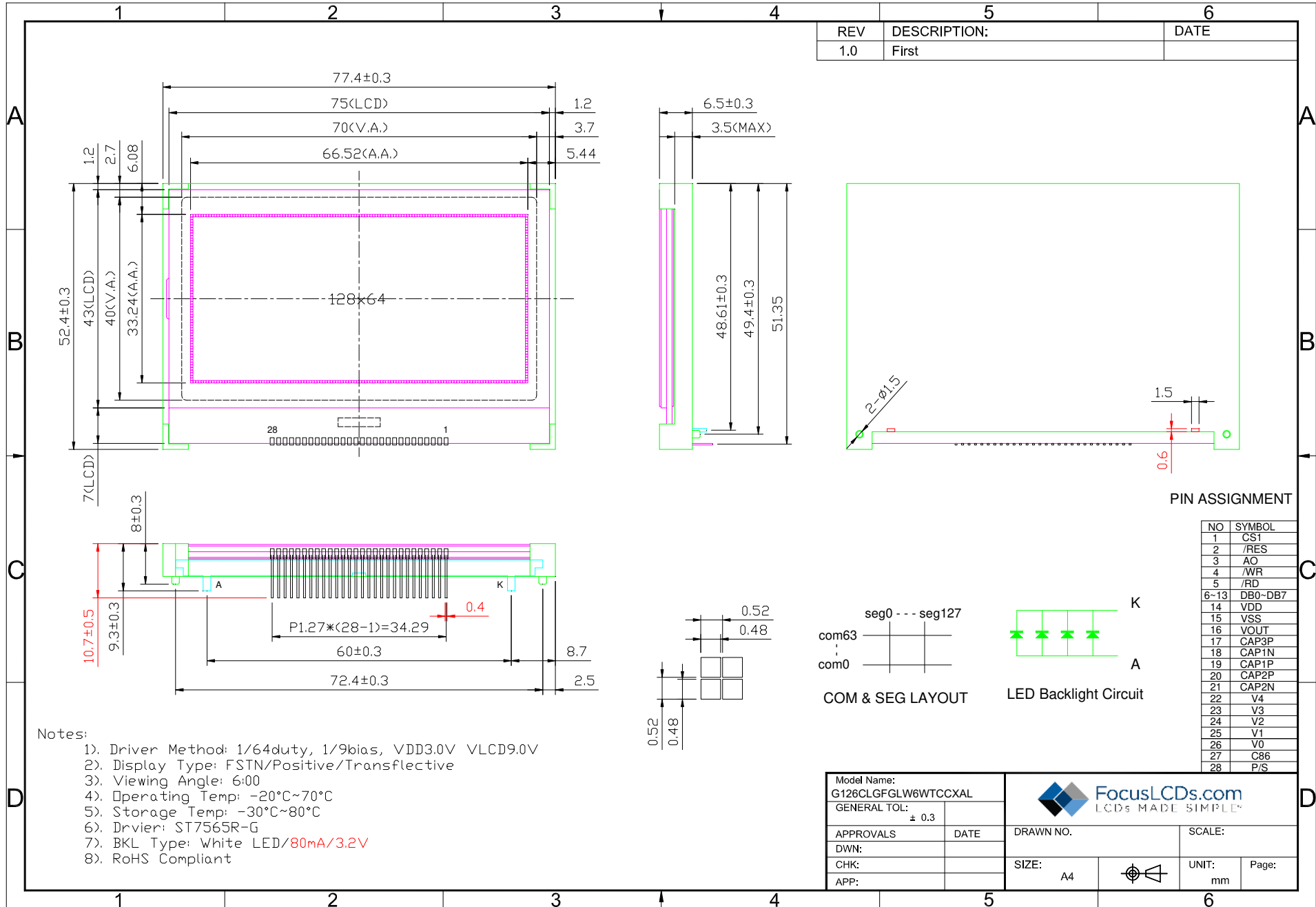

4. Absolute maximum ratings

Item	Symbol	Min.	Typ.	Max.	Unit
Power voltage logic	$V_{DD}-V_{SS}$	0.3	-	3.6	V
Input voltage	V_{IN}	-0.3	-	$V_{DD}+0.3$	
Power supply for LCD	V_0-V_{SS}	-0.3	-	13.5	
Operating temperature range	V_{OP}	-20	-	+70	°C
Storage temperature range	V_{ST}	-30	-	+80	

5. Block diagram

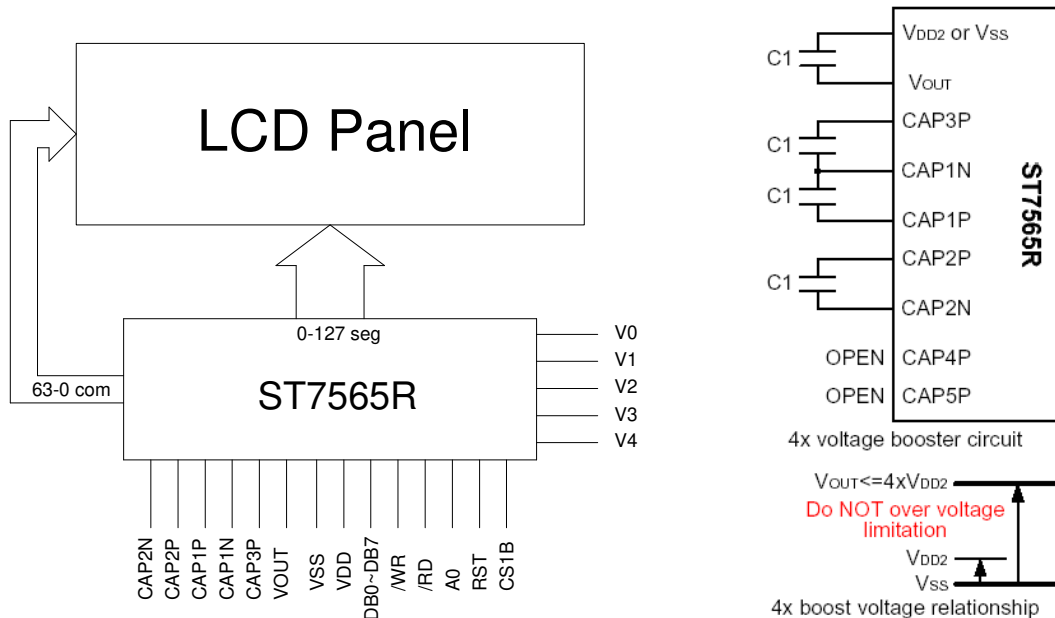

6. Interface pin description

Pin no.	Symbol	External connection	Function
1	CS1	MPU	Chip select in serial interface low active
2	/RST	MPU	External reset PIN. Must be fixed to VDD low active.
3	A0	MPU	Select registers. 0: instruction; 1: data register
4	/WR	MPU	Read/write select signal
5	/RD	MPU	Operation (data read/write) enable signal
6~13	DB0~DB7	MPU	This is an 8-bit-directional data bus.
14	V_{DD}	Power supply	Power supply for logic for LCM
15	V_{SS}		Signal ground for LCM
16	V_{OUT}		DC/DC voltage converter
17	CAP3P		For voltage booster circuit. External capacitor about 0.47uF~2.2uF.
18	CAP1N		
19	CAP1P		
20	CAP2P		
21	CAP2N		
22~26	V4~V0		Power supply LCD
27	C86		MPU
28	P/S	MPU	This is the parallel input/serial data input switch terminal.

7. Contrast adjust

The Voltage Regulator Circuit

The step-up voltage generated at V_{OUT} outputs the LCD driver voltage V_0 through the voltage regulator circuit. Because the ST7565R chips have an internal high-accuracy fixed voltage power supply with a 64-level electronic volume

function and internal resistors for the V_0 voltage regulator, systems can be constructed without having to include high-accuracy voltage regulator circuit components. (V_{REG} thermal gradients approximate $-0.05\%/^{\circ}\text{C}$)

(A) When the V_0 Voltage Regulator Internal Resistors Are Used

Through the use of the V_0 voltage regulator internal resistors and the electronic volume function the liquid crystal power supply voltage V_0 can be controlled by commands alone (without adding any external resistors), making it possible to

adjust the liquid crystal display brightness. The V_0 voltage can be calculated using equation A-1 over the range where $|V_0| < |V_{OUT}|$.

$$\begin{aligned}
 V_0 &= \left(1 + \frac{R_b}{R_a}\right) \cdot V_{EV} \\
 &= \left(1 + \frac{R_b}{R_a}\right) \cdot \left(1 - \frac{\alpha}{162}\right) \cdot V_{REG} \\
 \left[\because V_{EV} &= \left(1 - \frac{\alpha}{162}\right) \cdot V_{REG} \right]
 \end{aligned}$$

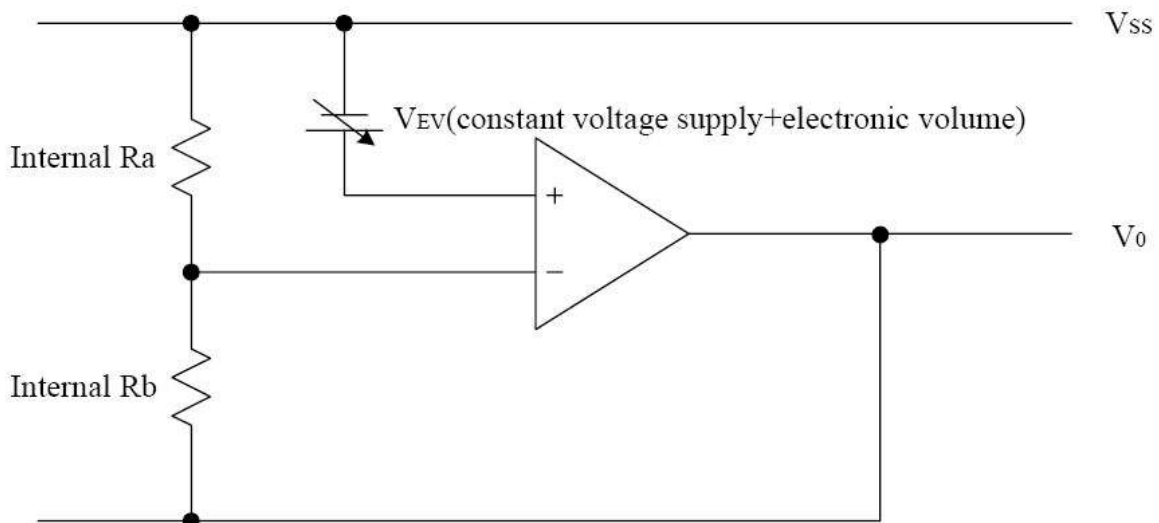

Figure 8

V_{REG} is the IC-internal fixed voltage supply, and its voltage at $T_a = 25^{\circ}\text{C}$ is as shown in Table 9.

Table 9

Part no.	Equipment Type	Thermal Gradient	V_{REG}
ST7565R	Internal Power Supply	$-0.05\%/^{\circ}\text{C}$	2.1V

α is set to 1 level of 64 possible levels by the electronic volume function depending on the data set in the 6-bit electronic volume registers. Table 10 shows the value for α depending on the electronic volume register settings.

R_b/R_a is the V_0 voltage regulator internal resistor ratio, and can be set to 8 different levels through the V_0 voltage regulator internal resistor ratio set command. The $(1 + R_b/R_a)$ ratio assumes the values shown in Table 11 depending on the 3-bit data settings in the V_0 voltage regulator internal resistor ratio register.

Table 10

D5	D4	D3	D2	D1	D0	α
0	0	0	0	0	0	63
0	0	0	0	0	1	62
0	0	0	0	1	0	61
			:			:
			:			:
1	1	1	1	0	1	2
1	1	1	1	1	0	1
1	1	1	1	1	1	0

V_0 voltage regulator internal resistance ratio register value and $(1 + R_b/R_a)$ ratio (Reference value)

Table 11

Register			ST7565R
D2	D1	D0	(1) $-0.05\%/^{\circ}\text{C}$
0	0	0	3.0
0	0	1	3.5
0	1	0	4.0
0	1	1	4.5
1	0	0	5.0
1	0	1	5.5
1	1	0	6.0
1	1	1	6.5

Figures 9, 10 show V_0 voltage measured by values of the internal resistance ratio resistor for V_0 voltage adjustment and electric volume resistor for each temperature grade model.

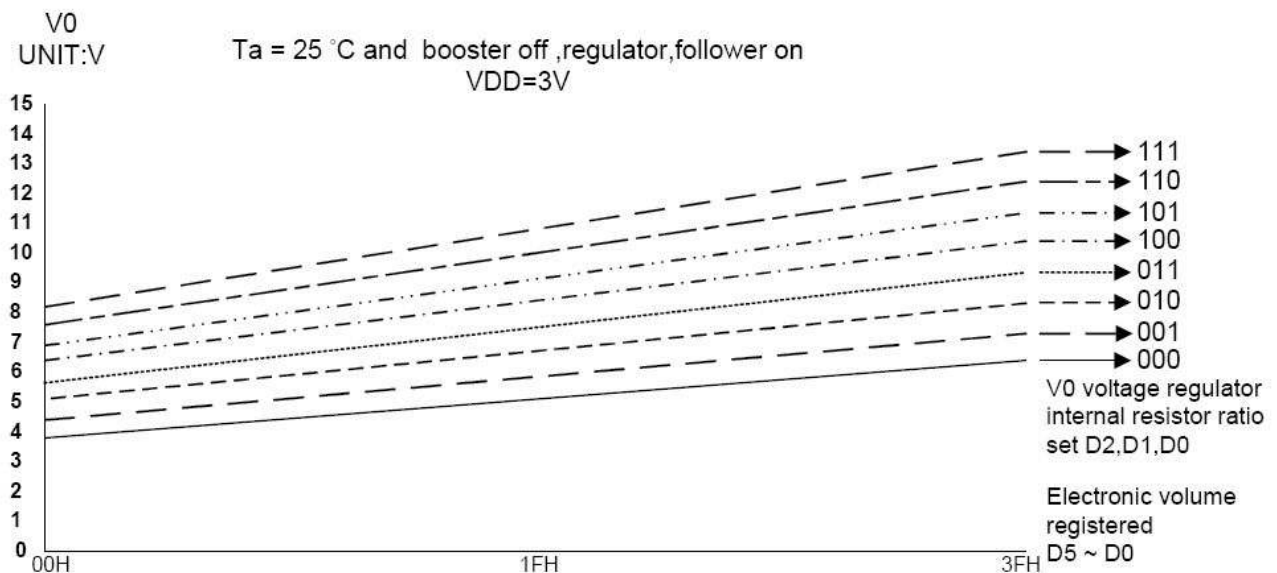

Figure 9 : (1) For ST7565R the Thermal Gradient = $-0.05\%/^{\circ}\text{C}$

The V_0 voltage as a function of the V_0 voltage regulator internal resistor ratio register and the electronic volume register.

Setup example: When selecting $T_a = 25^{\circ}\text{C}$ and $V_0 = 7\text{V}$ for an ST7565R on which Temperature gradient = $-0.05\%/^{\circ}\text{C}$.

Using Figure 9 and the equation A-1, the following setup is enabled.

At this time, the variable range and the notch width of the V_0 voltage is, as shown Table 13, as dependent on the electronic volume.

Table 12

Contents	Register					
	D5	D4	D3	D2	D1	D0
For V ₀ voltage regulator	—	—	—	0	1	0
Electronic Volume	1	0	0	1	0	1

Table 13

V ₀	Min	Typ	Max	Units
Variable Range	5.1 (63 levels)	7.0 (central value)	8.4 (0 level)	[V]
Notch width		51		[mV]

8. Optical characteristics

FSTN type display module

(Ta=25°C, VDD=3.0V)

Item	Symbol	Condition	Min.	Typ.	Max.	Unit
Viewing angle	$\theta 2- \theta 1$	CR=2.0	70	-	-	deg
	Φ		-	± 30	-	
Contrast ratio	CR	$\Phi = 0, \theta = 25$	3	5	-	-
Response time (rise)	tr		-	150	250	ms
Response time (fall)	tf		-	200	300	

9. Electrical characteristics

DC characteristics

Parameter	Symbol	Conditions	Min.	Typ.	Max.	Unit
Supply voltage for LCD	V ₀ -V _{SS}	Ta =25°C	-	9.0	-	V
Supply voltage for logic	V _{DD}		2.85	3.0	3.15	
Supply current	I _{DD}	Ta=25°C, V _{DD} =3.0V	-	0.5	-	mA
Backlight supply voltage	V _F		3.0	-	3.2	V
Backlight supply current	I _{LED}	V _F =3.2V	-	80	-	mA

(Ta=25°C, VDD=3.0V)

Item	Signal	Symbol	Min.	Typ.	Max.	Unit
Reset time		t _R	-	-	1.0	us
Reset 'L' pulse width	/RES	t _{RW}	1.0	-	-	

Reset Timing

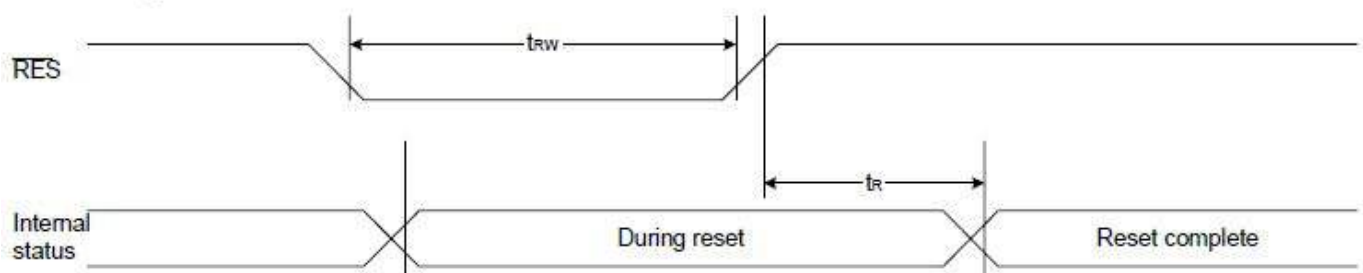

10. Timing Characteristics

System bus read/write characteristics 1 (for the 8080 series MPU)

(Ta=25°C, VDD=3.0V)

Item	Signal	Symbol	condition	Min.	Max.	Unit
Address hold time	A0	tAH8		0	-	ns
Address setup time		tAW8		0	-	
Address cycle time		tCYC8		240	-	
Enable L pulse width(write)	WR	tCCLW		80	-	
Enable H pulse width(write)		tCCHW		80	-	
Enable L pulse width(read)	RD	tCCLR		140	-	
Enable H pulse width(read)		tCCHR		80	-	
Write data setup time	DB0~DB7	tDS8		40	-	
Write address hold time		tDH8		0	-	
Read access time		tACC8	CL=100Pf	-	70	
Read output disable time		tOH8	CL=100Pf	5	50	

System Bus Read/Write Characteristics 1 (For the 8080 Series MPU)

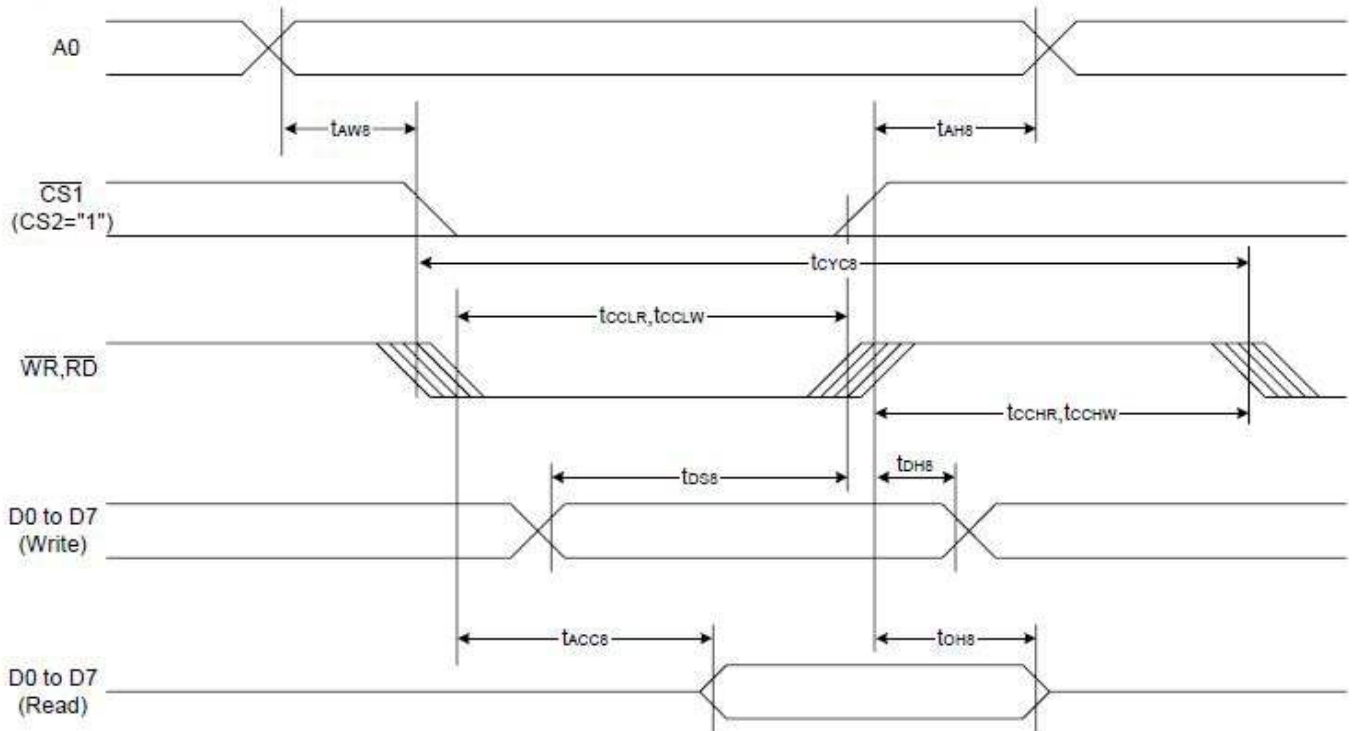

System bus read/write characteristics 2 (for the 6800 series MPU)

(Ta=25°C, VDD=3.0V)

Item	Signal	Symbol	condition	Min.	Max.	Unit
Address hold time	A0	tAH6		0	-	ns
Address setup time		tAW6		0	-	
Address cycle time		tCYC6		240	-	
Enable L pulse width(write)	WR	tCCLW		80	-	
Enable H pulse width(write)		tCCHW		80	-	
Enable L pulse width(read)	RD	tCCLR		80	-	
Enable H pulse width(read)		tCCHR		140	-	
Write data setup time	DB0~DB7	tDS6		40	-	
Write address hold time		tDH6		0	-	
Read access time		tACC6	CL=100Pf	-	70	
Read output disable time		tOH6	CL=100Pf	5	50	

System Bus Read/Write Characteristics 2 (For the 6800 Series MPU)

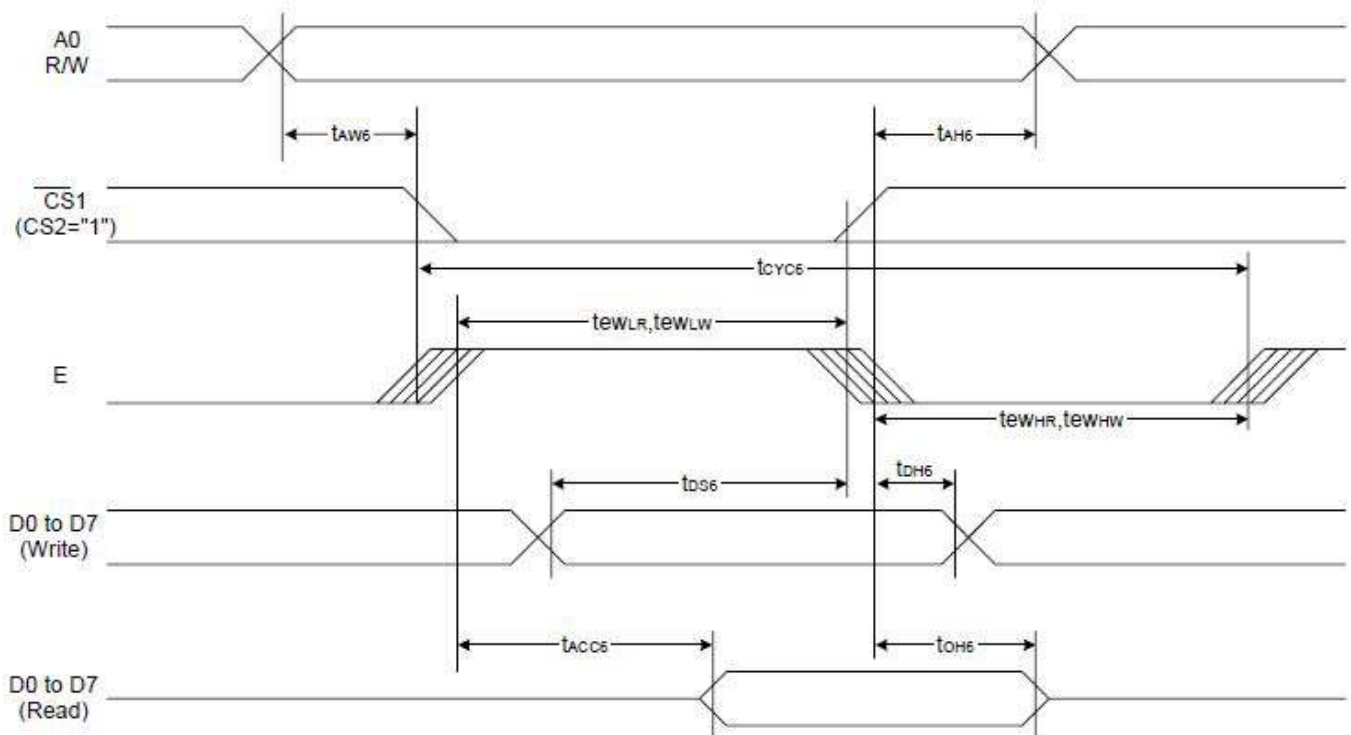

Display Data RAM

The display data RAM stores the dot data for the LCD. It has a 65 (8 page × 8 bit + 1) × 132 bit structure.

As is shown in Figure 3, the D7 to D0 display data from the MPU corresponds to the LCD display common direction; there are few constraints at the time of display data transfer when multiple ST7565R are used, thus and display structures can be created easily and with a high degree of

freedom.

Moreover, reading from and writing to the display RAM from the MPU side is performed through the I/O buffer, which is an independent operation from signal reading for the liquid crystal driver. Consequently, even if the display data RAM is accessed asynchronously during liquid crystal display, it will not cause adverse effects on the display (such as flickering).

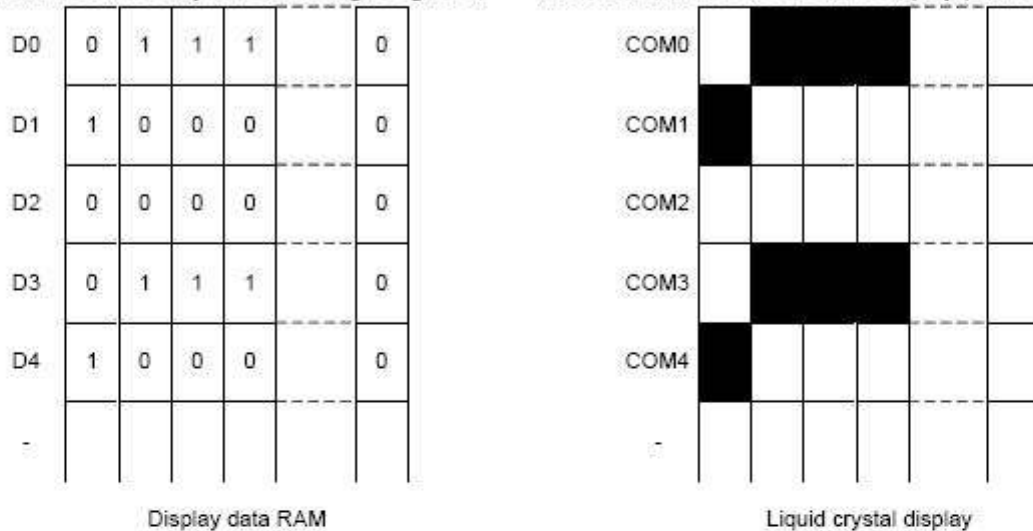

Figure 3

The Page Address Circuit

Page address of the display data RAM is specified through the Page Address Set Command. The page address must be specified again when changing pages to perform access.

Page address 8 (D3, D2, D1, D0 = 1, 0, 0, 0) is a special RAM for icons, and only display data D0 is used. (see Figure 4)

The Column Addresses

The display data RAM column address is specified by the Column Address Set command. The specified column address is incremented (+1) with each display data read/write command. This allows the MPU display data to be accessed continuously. Moreover, the incrementing of column addresses stops with 83H. Because the column address is independent of the page address, when moving, for example, from page 0 column 83H to page 1 column 00H,

it is necessary to respective both the page address and the column address.

Furthermore, as is shown in Table 4, the ADC command (segment driver direction select command) can be used to reverse the relationship between the display data RAM column address and the segment output. Because of this, the constraints on the IC layout when the LCD module is assembled can be minimized. As is shown in Figure 4,

Table 4

SEG Output ADC	SEG0	SEG 131
(D0) "0"	0 (H) → Column Address	83 (H)
(D0) "1"	83 (H) ← Column Address	0 (H)

The Line Address Circuit

The line address circuit, as shown in Table 4, specifies the line address relating to the COM output when the contents of the display data RAM are displayed. Using the display start line address set command, what is normally the top line of the display can be specified (this is the COM0 output when the common output mode is normal, and the COM63 output

for ST7565R, the detail is shown page.11 The display area is a 65 line area for the ST7565R.

If the line addresses are changed dynamically using the display start line address set command, screen scrolling, page swapping, etc. can be performed.

11. Instruction description

Table 16: Table of ST7565R Commands

(Note) *: ignored data

Command	Command Code										Function		
	A0	/RD	/WR	D7	D6	D5	D4	D3	D2	D1		D0	
(1) Display ON/OFF	0	1	0	1	0	1	0	1	1	1	0	1	LCD display ON/OFF 0: OFF, 1: ON
(2) Display start line set	0	1	0	0	1	Display start address					1	Sets the display RAM display start line address	
(3) Page address set	0	1	0	1	0	1	1	Page address				1	Sets the display RAM page address
(4) Column address set upper bit	0	1	0	0	0	0	1	Most significant column address				1	Sets the most significant 4 bits of the display RAM column address.
Column address set lower bit				0	0	0	0	Least significant column address					Sets the least significant 4 bits of the display RAM column address.
(5) Status read	0	0	1	Status			0	0	0	0	0	1	Reads the status data
(6) Display data write	1	1	0	Write data							0	Writes to the display RAM	
(7) Display data read	1	0	1	Read data							0	Reads from the display RAM	
(8) ADC select	0	1	0	1	0	1	0	0	0	0	0	1	Sets the display RAM address SEG output correspondence 0: normal, 1: reverse
(9) Display normal/reverse	0	1	0	1	0	1	0	0	1	1	0	1	Sets the LCD display normal/ reverse 0: normal, 1: reverse
(10) Display all points ON/OFF	0	1	0	1	0	1	0	0	1	0	0	1	Display all points 0: normal display 1: all points ON
(11) LCD bias set	0	1	0	1	0	1	0	0	0	1	0	1	Sets the LCD drive voltage bias ratio 0: 1/9 bias, 1: 1/7 bias (ST7565R)
(12) Read-modify-write	0	1	0	1	1	1	0	0	0	0	0	0	Column address increment At write: +1 At read: 0
(13) End	0	1	0	1	1	1	0	1	1	1	0	0	Clear read/modify/write
(14) Reset	0	1	0	1	1	1	0	0	0	1	0	0	Internal reset
(15) Common output mode select	0	1	0	1	1	0	0	0	*	*	*	1	Select COM output scan direction 0: normal direction 1: reverse direction
(16) Power control set	0	1	0	0	0	1	0	1	Operating mode		0	0	Select internal power supply operating mode
(17) V ₀ voltage regulator internal resistor ratio set	0	1	0	0	0	1	0	0	Resistor ratio		0	0	Select internal resistor ratio(Rb/Ra) mode
(18) Electronic volume mode set	0	1	0	1	0	0	0	0	0	0	0	1	Set the V ₀ output voltage electronic volume register
Electronic volume register set				0	0	Electronic volume value							
(19) Sleep mode set	0	1	0	1	0	1	0	1	1	0	0	1	0: Sleep mode, 1: Normal mode
(20) Booster ratio set	0	1	0	1	1	1	1	1	0	0	0	0	select booster ratio 00: 2x,3x,4x 01: 5x 11: 6x
(21) NOP	0	1	0	1	1	1	0	0	0	1	1	1	Command for non-operation
(22) Test	0	1	0	1	1	1	1	*	*	*	*	*	Command for IC test. Do not use this command

12. QUALITY SPECIFICATIONS

12.1 Standard of the product appearance test

Manner of appearance test: The inspection should be performed in using 20W x 2 fluorescent lamps. Distance between LCM and fluorescent lamps should be 100 cm or more. Distance between LCM and inspector eyes should be 30 cm or more.

Viewing direction for inspection is 45° from vertical against LCM.

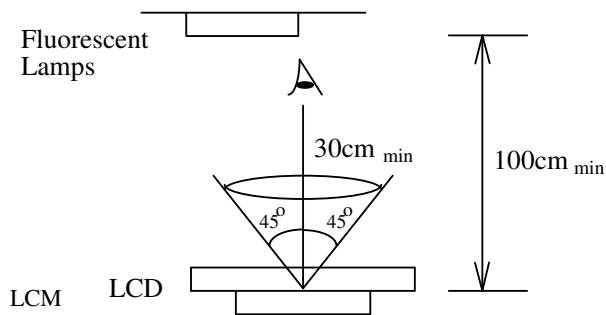

Definition of zone:

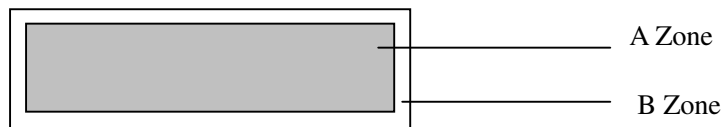

A Zone: Active display area (minimum viewing area).

B Zone: Non-active display area (outside viewing area).

12.2 Specification of quality assurance

AQL inspection standard

Sampling method: MIL-STD-105E, Level II, single sampling

Defect classification **(Note: * is not including)**

Classify	Item		Note	AQL
Major	Display state	Short or open circuit	1	0.65
		LC leakage		
		Flickering		
		No display		
		Wrong viewing direction		
		Contrast defect (dim, ghost)	2	
		Back-light	1,8	
	Non-display	Flat cable or pin reverse	10	
Wrong or missing component		11		
Minor	Display state	Background color deviation	2	1.0
		Black spot and dust	3	
		Line defect, Scratch	4	
		Rainbow	5	
		Chip	6	
		Pin hole	7	
		Protruded	12	
	Polarizer	Bubble and foreign material	3	
	Soldering	Poor connection	9	
	Wire	Poor connection	10	
	TAB	Position, Bonding strength	13	

Note on defect classification

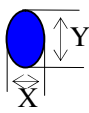
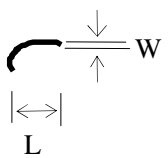
No.	Item	Criterion																				
1	Short or open circuit	Not allow																				
	LC leakage																					
	Flickering																					
	No display																					
	Wrong viewing direction																					
	Wrong Back-light																					
2	Contrast defect	Refer to approval sample																				
	Background color deviation																					
3	Point defect, Black spot, dust (including Polarizer)	 <table border="1" data-bbox="861 981 1300 1276"> <thead> <tr> <th>Point Size</th> <th>Acceptable Qty.</th> </tr> </thead> <tbody> <tr> <td>$\phi \leq 0.10$</td> <td>Disregard</td> </tr> <tr> <td>$0.10 < \phi \leq 0.20$</td> <td>3</td> </tr> <tr> <td>$0.20 < \phi \leq 0.25$</td> <td>2</td> </tr> <tr> <td>$0.25 < \phi \leq 0.30$</td> <td>1</td> </tr> <tr> <td>$\phi > 0.30$</td> <td>0</td> </tr> </tbody> </table> <p style="text-align: right;">Unit: mm</p>	Point Size	Acceptable Qty.	$\phi \leq 0.10$	Disregard	$0.10 < \phi \leq 0.20$	3	$0.20 < \phi \leq 0.25$	2	$0.25 < \phi \leq 0.30$	1	$\phi > 0.30$	0								
	Point Size		Acceptable Qty.																			
$\phi \leq 0.10$	Disregard																					
$0.10 < \phi \leq 0.20$	3																					
$0.20 < \phi \leq 0.25$	2																					
$0.25 < \phi \leq 0.30$	1																					
$\phi > 0.30$	0																					
	$\phi = (X+Y)/2$																					
4	Line defect, Scratch	 <table border="1" data-bbox="790 1411 1340 1668"> <thead> <tr> <th colspan="2">Line</th> <th>Acceptable Qty.</th> </tr> <tr> <th>L</th> <th>W</th> <th></th> </tr> </thead> <tbody> <tr> <td>---</td> <td>$0.015 \geq W$</td> <td>Disregard</td> </tr> <tr> <td>$3.0 \geq L$</td> <td>$0.03 \geq W$</td> <td rowspan="2">2</td> </tr> <tr> <td>$2.0 \geq L$</td> <td>$0.05 \geq W$</td> </tr> <tr> <td>$1.0 \geq L$</td> <td>$0.1 > W$</td> <td>1</td> </tr> <tr> <td>---</td> <td>$0.05 < W$</td> <td>Applied as point defect</td> </tr> </tbody> </table> <p style="text-align: right;">Unit: mm</p>	Line		Acceptable Qty.	L	W		---	$0.015 \geq W$	Disregard	$3.0 \geq L$	$0.03 \geq W$	2	$2.0 \geq L$	$0.05 \geq W$	$1.0 \geq L$	$0.1 > W$	1	---	$0.05 < W$	Applied as point defect
	Line		Acceptable Qty.																			
L	W																					
---	$0.015 \geq W$	Disregard																				
$3.0 \geq L$	$0.03 \geq W$	2																				
$2.0 \geq L$	$0.05 \geq W$																					
$1.0 \geq L$	$0.1 > W$	1																				
---	$0.05 < W$	Applied as point defect																				
5	Rainbow	Not more than two color changes across the viewing area.																				

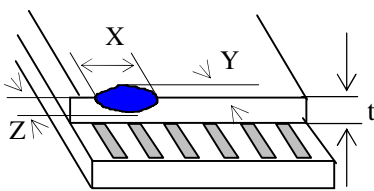
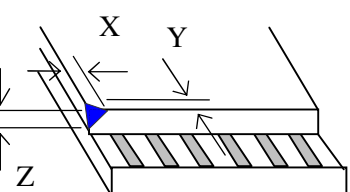
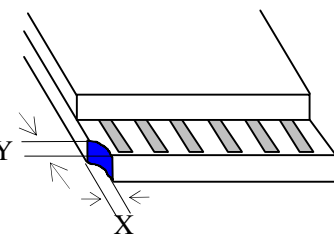
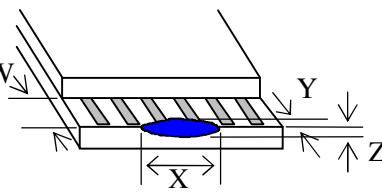
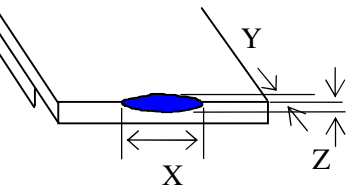
No	Item	Criterion																																	
6	Chip Remark: X: Length direction Y: Short direction Z: Thickness direction t: Glass thickness W: Terminal Width	<div style="display: flex; flex-direction: column; align-items: flex-start;"> <div style="display: flex; align-items: flex-start; margin-bottom: 20px;">  <div style="margin-left: 20px;"> <p>Acceptable criterion</p> <table border="1" data-bbox="933 425 1324 504"> <thead> <tr> <th>X</th> <th>Y</th> <th>Z</th> </tr> </thead> <tbody> <tr> <td>≤ 2</td> <td>0.5mm</td> <td>$\leq t/2$</td> </tr> </tbody> </table> </div> </div> <div style="display: flex; align-items: flex-start; margin-bottom: 20px;">  <div style="margin-left: 20px;"> <p>Acceptable criterion</p> <table border="1" data-bbox="925 739 1324 817"> <thead> <tr> <th>X</th> <th>Y</th> <th>Z</th> </tr> </thead> <tbody> <tr> <td>≤ 2</td> <td>0.5mm</td> <td>$\leq t$</td> </tr> </tbody> </table> </div> </div> <div style="display: flex; align-items: flex-start; margin-bottom: 20px;">  <div style="margin-left: 20px;"> <p>Acceptable criterion</p> <table border="1" data-bbox="933 1030 1324 1142"> <thead> <tr> <th>X</th> <th>Y</th> <th>Z</th> </tr> </thead> <tbody> <tr> <td>≤ 3</td> <td>≤ 2</td> <td>$\leq t$</td> </tr> <tr> <td colspan="2">shall not reach to ITO</td> <td></td> </tr> </tbody> </table> </div> </div> <div style="display: flex; align-items: flex-start; margin-bottom: 20px;">  <div style="margin-left: 20px;"> <p>Acceptable criterion</p> <table border="1" data-bbox="925 1411 1324 1489"> <thead> <tr> <th>X</th> <th>Y</th> <th>Z</th> </tr> </thead> <tbody> <tr> <td>Disregard</td> <td>≤ 0.2</td> <td>$\leq t$</td> </tr> </tbody> </table> </div> </div> <div style="display: flex; align-items: flex-start;">  <div style="margin-left: 20px;"> <p>Acceptable criterion</p> <table border="1" data-bbox="925 1691 1292 1769"> <thead> <tr> <th>X</th> <th>Y</th> <th>Z</th> </tr> </thead> <tbody> <tr> <td>≤ 5</td> <td>≤ 2</td> <td>$\leq t/3$</td> </tr> </tbody> </table> </div> </div> </div>	X	Y	Z	≤ 2	0.5mm	$\leq t/2$	X	Y	Z	≤ 2	0.5mm	$\leq t$	X	Y	Z	≤ 3	≤ 2	$\leq t$	shall not reach to ITO			X	Y	Z	Disregard	≤ 0.2	$\leq t$	X	Y	Z	≤ 5	≤ 2	$\leq t/3$
X	Y	Z																																	
≤ 2	0.5mm	$\leq t/2$																																	
X	Y	Z																																	
≤ 2	0.5mm	$\leq t$																																	
X	Y	Z																																	
≤ 3	≤ 2	$\leq t$																																	
shall not reach to ITO																																			
X	Y	Z																																	
Disregard	≤ 0.2	$\leq t$																																	
X	Y	Z																																	
≤ 5	≤ 2	$\leq t/3$																																	

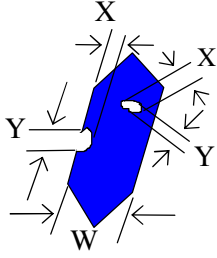
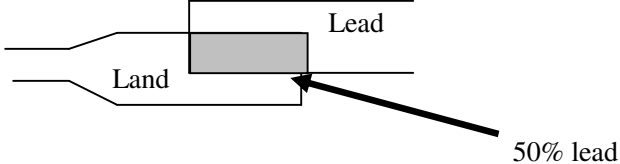
No.	Item	Criterion								
7	Segment pattern $W = \text{Segment width}$ $\phi = (X+Y)/2$	(1) Pin hole $\phi < 0.10\text{mm}$ is acceptable.  <table border="1" data-bbox="853 528 1316 698"> <thead> <tr> <th>Point Size</th> <th>Acceptable Qty</th> </tr> </thead> <tbody> <tr> <td>$\phi \leq 1/4W$</td> <td>Disregard</td> </tr> <tr> <td>$1/4W < \phi \leq 1/2W$</td> <td>1</td> </tr> <tr> <td>$\phi > 1/2W$</td> <td>0</td> </tr> </tbody> </table> <p style="text-align: right;">Unit: mm</p>	Point Size	Acceptable Qty	$\phi \leq 1/4W$	Disregard	$1/4W < \phi \leq 1/2W$	1	$\phi > 1/2W$	0
Point Size	Acceptable Qty									
$\phi \leq 1/4W$	Disregard									
$1/4W < \phi \leq 1/2W$	1									
$\phi > 1/2W$	0									
8	Back-light	(1) The color of backlight should correspond its specification. (2) Not allow flickering								
9	Soldering	(1) Not allow heavy dirty and solder ball on PCB. (The size of dirty refer to point and dust defect) (2) Over 50% of lead should be soldered on Land. 								
10	Wire	(1) Copper wire should not be rusted (2) Not allow crack on copper wire connection. (3) Not allow reversing the position of the flat cable. (4) Not allow exposed copper wire inside the flat cable.								
11*	PCB	(1) Not allow screw rust or damage. (2) Not allow missing or wrong putting of component.								

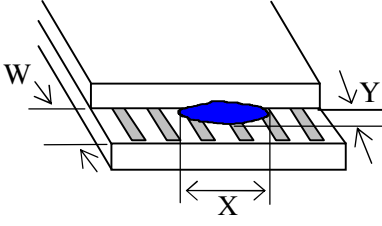
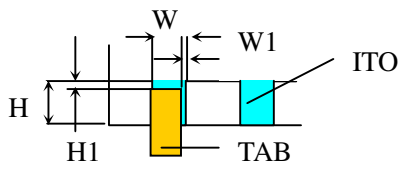
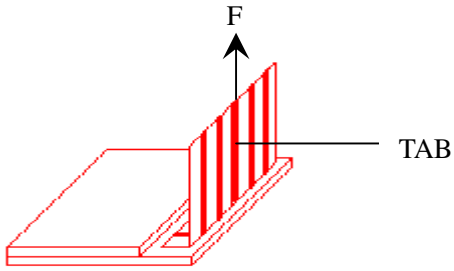
No	Item	Criterion
12	Protruded W: Terminal Width	 <p>Acceptable criteria: $Y \leq 0.4$</p>
13	TAB	<p>1. Position</p>  <div style="border: 1px solid black; padding: 5px; width: fit-content; margin-left: auto; margin-right: auto;"> $W1 \leq 1/3W$ $H1 \leq 1/3H$ </div> <p>2. TAB bonding strength test</p>  <p> $P (=F/TAB \text{ bonding width}) \geq 650\text{gf/cm}$,(speed rate: 1mm/min) 5pcs per SOA (shipment) </p>
14	Total no. of acceptable Defect	<p>A. Zone</p> <p>Maximum 2 minor non-conformities per one unit. Defect distance: each point to be separated over 10mm</p> <p>B. Zone</p> <p>It is acceptable when it is no trouble for quality and assembly in customer's end product.</p>

12.3 Reliability of LCM

Reliability test condition:

Item	Condition	Time (hrs)	Assessment
High temp. Storage	80°C	48	No abnormalities in functions and appearance
High temp. Operating	70°C	48	
Low temp. Storage	-30°C	48	
Low temp. Operating	-20°C	48	
Humidity	40°C/ 90%RH	48	
Temp. Cycle	0°C ← 25°C → 50°C (30 min ← 5 min → 30min)	10cycles	

Recovery time should be 24 hours minimum. Moreover, functions, performance and appearance shall be free from remarkable deterioration within 50,000 hours under ordinary operating and storage conditions room temperature (20±8°C), normal humidity (below 65% RH), and in the area not exposed to direct sun light.

12.4 Precaution for using LCD/LCM

LCD/LCM is assembled and adjusted with a high degree of precision. Do not attempt to make any alteration or modification. The followings should be noted.

General Precautions:

1. LCD panel is made of glass. Avoid excessive mechanical shock or applying strong pressure onto the surface of display area.
2. The polarizer used on the display surface is easily scratched and damaged. Extreme care should be taken when handling. To clean dust or dirt off the display surface, wipe gently with cotton, or other soft material soaked with isopropyl alcohol, ethyl alcohol or trichlorotrifluoroethane, do not use water, ketone or aromatics and never scrub hard.
3. Do not tamper in any way with the tabs on the metal frame.
4. Do not make any modification on the PCB without consulting FocusLCDs
5. When mounting a LCM, make sure that the PCB is not under any stress such as bending or twisting. Elastomer contacts are very delicate and missing pixels could result from slight dislocation of any of the elements.
6. Avoid pressing on the metal bezel, otherwise the elastomer connector could be deformed and lose contact, resulting in missing pixels and also cause rainbow on the display.
7. Be careful not to touch or swallow liquid crystal that might leak from a damaged cell. Any liquid crystal adheres to skin or clothes, wash it off immediately with soap and water.

Static Electricity Precautions:

1. CMOS-LSI is used for the module circuit; therefore operators should be grounded whenever he/she comes into contact with the module.
2. Do not touch any of the conductive parts such as the LSI pads; the copper leads on the PCB and the interface terminals with any parts of the human body.
3. Do not touch the connection terminals of the display with bare hand; it will cause disconnection or defective insulation of terminals.
4. The modules should be kept in anti-static bags or other containers resistant to static for storage.
5. Only properly grounded soldering irons should be used.
6. If an electric screwdriver is used, it should be grounded and shielded to prevent sparks.
7. The normal static prevention measures should be observed for work clothes and working benches.
8. Since dry air is inductive to static, a relative humidity of 50-60% is recommended.

Soldering Precautions:

1. Soldering should be performed only on the I/O terminals.
2. Use soldering irons with proper grounding and no leakage.
3. Soldering temperature: $280^{\circ}\text{C} \pm 10^{\circ}\text{C}$
4. Soldering time: 3 to 4 second.
5. Use lead free solder with no-clean flux.
6. If flux is used, the LCD surface should be protected to avoid spattering flux.
7. Flux residue should be removed.

Operation Precautions:

1. The viewing angle can be adjusted by varying the LCD driving voltage V_o .
2. Since applied DC voltage causes electro-chemical reactions, which deteriorate the display, the applied pulse waveform should be a symmetric waveform such that no DC component remains. Be sure to use the specified operating voltage.
3. Driving voltage should be kept within specified range; excess voltage will shorten display life.
4. Response time increases with decrease in temperature.
5. Display color may be affected at temperatures above its operational range.
6. Keep the temperature within the specified range usage and storage. Excessive temperature and humidity could cause polarization degradation, polarizer peel-off or generate bubbles.
7. For long-term storage over 40 °C is required, the relative humidity should be kept below 60%, and avoid direct sunlight.