



## Main

Range of Product	Telemecanique Photoelectric sensors XU
Series name	General purpose single mode
Electronic sensor type	Photo-electric sensor
Sensor name	XUX
Sensor design	Compact 92 x 71
Detection system	Diffuse
Material	Plastic
Type of output signal	Discrete
Supply circuit type	DC
Wiring Technique	3-wire
Discrete output type	PNP
Discrete output function	1 NO
Electrical connection	Screw-clamp terminals, 1 x 1.5 mm <sup>2</sup> or 1 x 0.75 mm <sup>2</sup> with adaptor
Product Specific Application	-
Emission	Infrared diffuse
[Sn] nominal sensing distance	6.89 ft (2.1 m) diffuse

## Complementary

Enclosure Material	PBT
Lens material	PMMA
Maximum sensing distance	9.84 ft (3 m) diffuse
Output Type	Solid state
Cable entry	1 entry for M16 x 1.5 cable gland 0.28...0.39 in (7...10 mm)
Status LED	1 LED yellow)output state 1 LED green)supply
[Us] rated supply voltage	12...24 V DC
Switching capacity in mA	<= 100 mA (overload and short-circuit protection)
Switching frequency	<= 250 Hz
Maximum voltage drop	<1.5 V (closed state)
Current consumption	<= 35 mA (no-load)
Maximum delay first up	15 ms
Maximum delay response	2 ms
Maximum delay recovery	2 ms
Setting-up	Sensitivity adjustment
Depth	3.03 in (77 mm)
Height	3.62 in (92 mm)
Width	1.22 in (31 mm)
Net Weight	0.44 lb(US) (0.2 kg)

## Environment

Product Certifications	CE UL CSA
Ambient air temperature for operation	-13...131 °F (-25...55 °C)
Ambient Air Temperature for Storage	-40...158 °F (-40...70 °C)
Vibration resistance	7 gn +/- 1.5 mm 10...55 Hz IEC 60068-2-6
Shock resistance	30 gn 11 ms) IEC 60068-2-27
IP degree of protection	IP67 double insulation IEC 60529 IP65 double insulation IEC 60529





## Ordering and shipping details

Category	22481-SENSORS, PHOTOELECTRIC
Discount Schedule	DS2
GTIN	3389110170917
Nbr. of units in pkg.	1
Package weight(Lbs)	6.56 oz (186.0 g)
Returnability	No
Country of origin	FR

## Packing Units

Unit Type of Package 1	PCE
Package 1 Height	1.61 in (4.1 cm)
Package 1 width	3.78 in (9.6 cm)
Package 1 Length	5.20 in (13.2 cm)
Unit Type of Package 2	S02
Number of Units in Package 2	22
Package 2 Weight	10.02 lb(US) (4.547 kg)
Package 2 Height	5.91 in (15 cm)
Package 2 width	11.81 in (30 cm)
Package 2 Length	15.75 in (40 cm)

## Offer Sustainability

Sustainable offer status	Green Premium product
California proposition 65	WARNING: This product can expose you to chemicals including: Diisononyl phthalate (DINP), which is known to the State of California to cause cancer, and Di-isodecyl phthalate (DIDP), which is known to the State of California to cause birth defects or other reproductive harm. For more information go to <a href="http://www.P65Warnings.ca.gov">www.P65Warnings.ca.gov</a>
REACH Regulation	 <a href="#">REACH Declaration</a>
EU RoHS Directive	Pro-active compliance (Product out of EU RoHS legal scope)  <a href="#">EU RoHS Declaration</a>
Mercury free	Yes
RoHS exemption information	 <a href="#">Yes</a>
Environmental Disclosure	 <a href="#">Product Environmental Profile</a>
Circularity Profile	 <a href="#">End Of Life Information</a>

## Contractual warranty

Warranty	18 months
----------	-----------

Dimensions

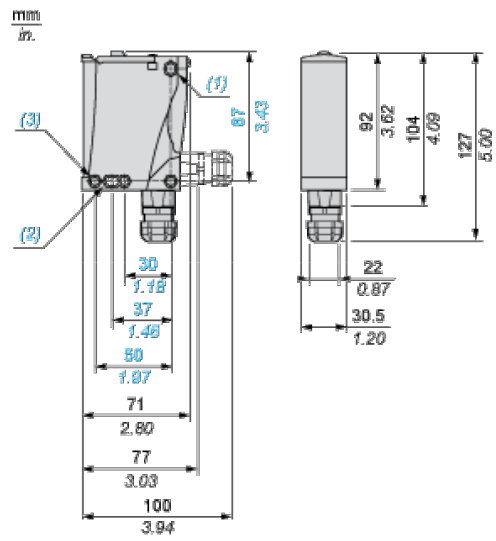

- (1) Elongated hole  $\text{\O} 5.5 \times 7$
- (2) Elongated hole  $\text{\O} 5.5 \times 9$
- (3)  $\text{\O} 5.5$  hole

## Wiring Schemes

### PNP/NPN DC

M12		Terminals		
1	●	1	⊘	+
3	●	2	⊘	-
4	●	3	⊘	Output

---

Detection Curves

---

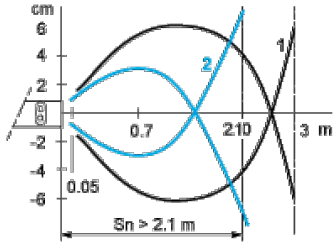

- 1 : White 90%
  - 2 : Grey 18%
- Object 10 x 10 cm