

DESCRIPTION: M12 MALE - CABLE MOUNT - 5 POS.

SPECIFICATIONS:

ELECTRICAL:

RATED CURRENT: 4A
 RATED VOLTAGE: 60V
 INSULATION RESISTANCE: 100 MOhms MIN.
 CONTACT RESISTANCE: 10 mOhms MAX.
 WATER PROOF: IP67

MATERIAL:

HOUSING: PBT UL94V-0, BLACK
 CONTACT: BRASS
 NUT: ALUMINUM ALLOY
 SHELL: ALUMINUM ALLOY
 MAIN BODY: ALUMINUM ALLOY
 GLAND: SILICONE, BLACK
 GLAND CAGE: POM, BLACK
 GLAND NUT: BRASS

FINISH:

CONTACT: GOLD PLATED OVER 50u" NICKEL
 NUT: NICKEL PLATED
 SHELL: NICKEL PLATED
 MAIN BODY: NICKEL PLATED
 GLAND NUT: NICKEL PLATED

ENVIRONMENT

OPERATION TEMPERATURE: -40°C TO +85°C

MAX WIRE AWG:

22 AWG

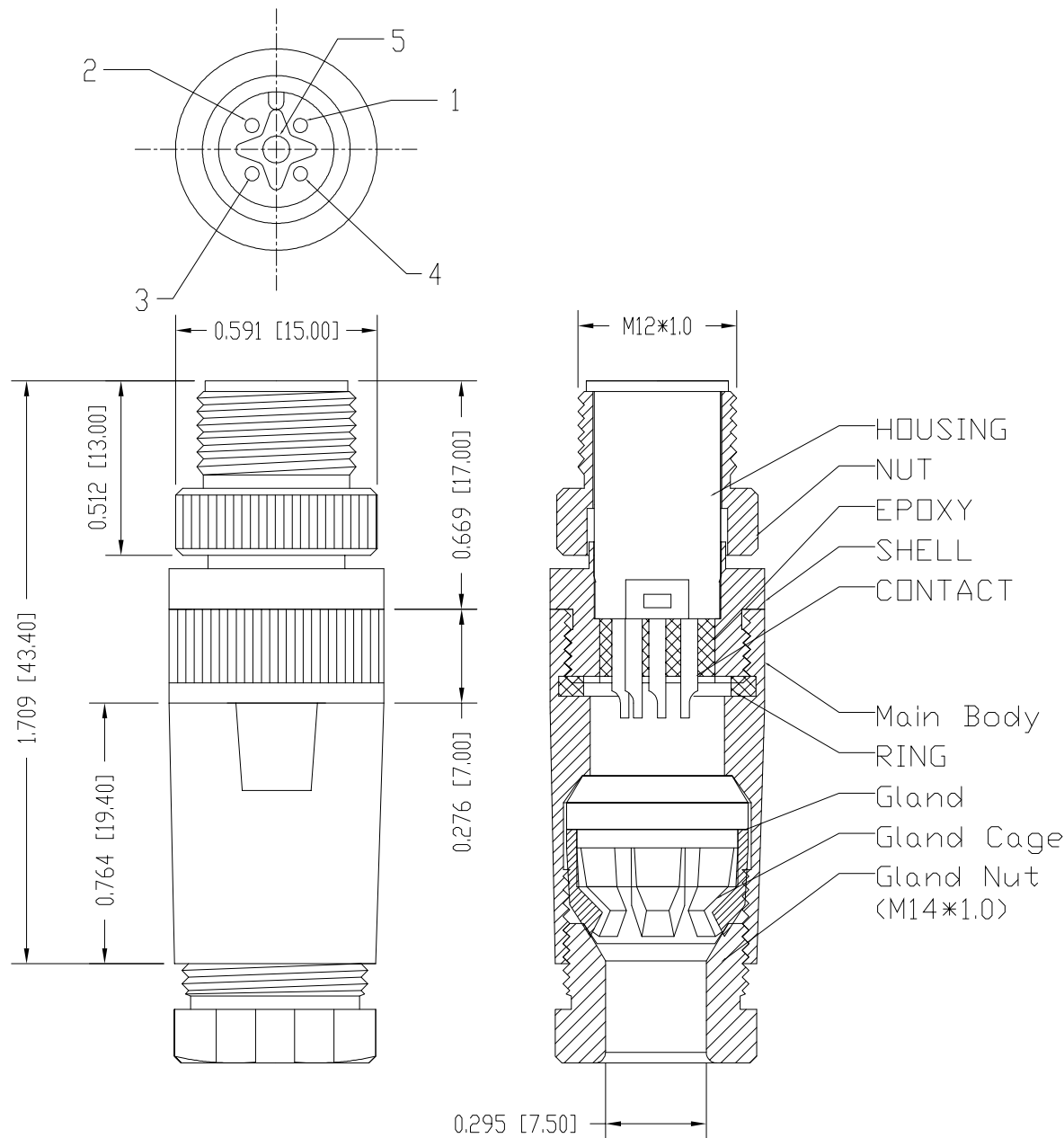

858-005-103RKTY

1 = GOLD FLASH
 4 = 10u" GOLD

RoHS COMPLIANT

UNITS = INCHES [MM]

DO NOT SCALE FROM DRAWING



THESE DRAWINGS AND SPECIFICATIONS ARE THE PROPERTY OF NorComp AND SHALL NOT BE REPRODUCED, COPIED OR USED AS THE BASIS FOR THE MANUFACTURE OR SALE OF APPARATUS WITHOUT WRITTEN PERMISSION.

DRAWN:

M. SIGMON

DATE:

03/07/2016

NorComp

SCALE:

NTS

SHEET

OF

1

1

REV

4

DWG NO.

858-005-103RKTY