

FIR00-03

Product Specification

1. Dimensions

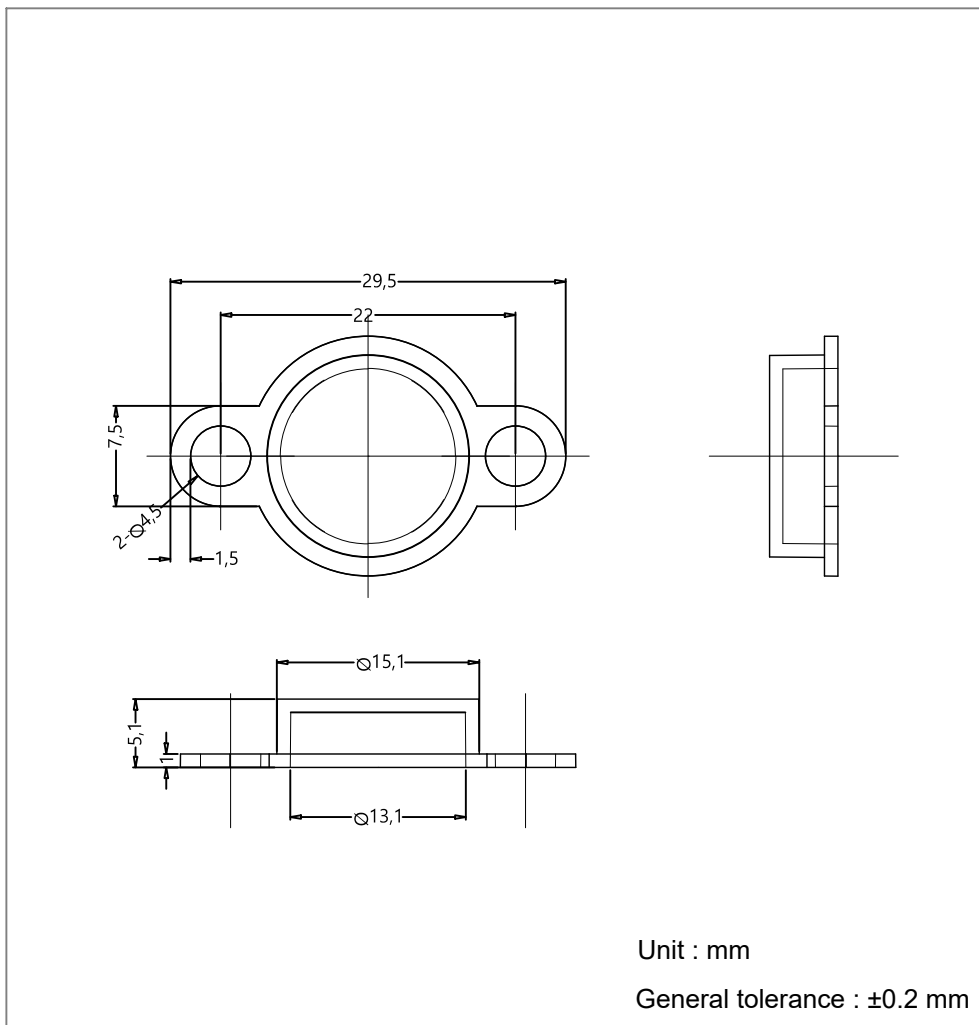

3. Material for PIR/FIR(8~13um) wavelength

The thermopile and passive infrared sensor that is using for motion sensor detects the wavelength of 8~13um.

Without Fresnel lens, the sensor only can detect less than 1m distance and narrower space with lens. To work with Pyroelectric detector and thermopile, Fresnel lens that collects infrared rays as a sensor is required. Fresnel Factory manufactures Fresnel lenses for passive infrared and absolute temperature sensors.

3-1) Poly FIR 25

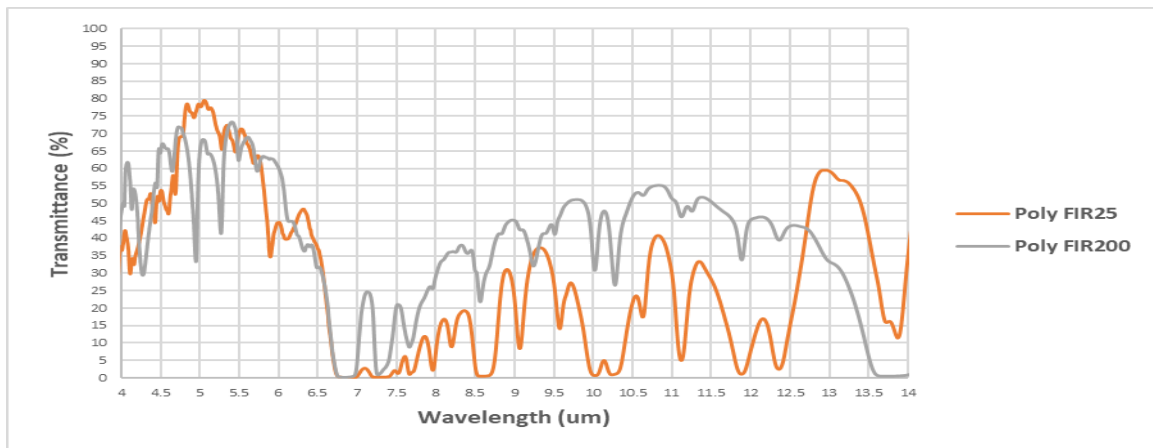

(Graph3 – Transmittance of PIR, FIR(Far infrared) material)

Material is important to have a wide FOV and excellent Far Infrared transmittance. Therefore, Fresnel Factory is using Poly FIR200 and Poly FIR25, which have a wide FOV and excellent FIR transmittance

Transmittance (%)

Material name	8~13um
Poly FIR25	19.24% at 0.50T

The FIR (Far-Infrared) sensor detects temperature by measuring infrared emitted from an object and is used in thermal imaging cameras. The transmittance of Poly FIR25 in the 8~13um wavelength is 19.24% on average, which is lower than that of Poly FIR200.

However, Poly FIR25 has better Hardness and high resistance of temperature.

Properties

Max tensile strength	*Impact strength	*Hardness	*HDT(0.45Map)	Meltflow Rate
26Mpa	70J/m	Rockwell M scale 70	130°C	2.5g/min

Poly FIR25 has higher tensile strength, impact strength, and HDT than Poly FIR200. Due to the above properties, Poly FIR25 is used for temperature sensing sensors exposed to high temperatures despite low transmittance.

Reference

*HDT(Heat Deflection Temperature) : It exhibits heat resistance at a specific temperature when the sample has displacement of 2.5mm under a specific load.

*Hardness : Abrasion resistance

*Izod Impact strength : Impact resistance