

## DESCRIPTION

The MPM3805A is an automotive grade, step-down module converter with built-in power MOSFETs and an inductor. The module's integrated inductor simplifies the power system design and provides easy and efficient use. The DC/DC module comes in a small surface-mounted QFN-12 (2.5mmx3.0mmx0.9mm) package and achieves 0.6A of peak output current from a 2.6V to 6V input voltage range with excellent load and line regulation. The output voltage can be regulated as low as 0.6V. Only FB resistors and input and output capacitors are needed to complete the design.

The constant-on-time control (COT) scheme provides fast transient response and eases loop stabilization. Fault condition protection includes cycle-by-cycle current limiting and thermal shutdown.

The MPM3805A is ideal for a wide range of automotive applications, including small ECUs, camera modules, telematics, and infotainment systems.

## FEATURES

- Guaranteed Industrial/Automotive Temp
- Wide 2.6V to 6V Operating Input Range
- Adjustable Output from 0.6V
- Up to 0.6A Peak Output Current
- 100% Duty Cycle in Dropout
- Forced CCM Mode
- EN and Power Good for Power Sequencing
- Cycle-by-Cycle Over-Current Protection (OCP)
- Short-Circuit Protection (SCP) with Hiccup Mode
- Only Four External Components Required: Two Ceramic Capacitors, Two FB Divider Resistors
- Available in a QFN-12 (2.5mm x 3.0mm x 0.9mm) Package
- Total Solution Size 6mmx3.8mm
- Available in AEC-Q100

## APPLICATIONS

- Automotive ECU
- Rear Cameras
- E-Call
- Telematics
- Infotainment Systems

All MPS parts are lead-free, halogen-free, and adhere to the RoHS directive. For MPS green status, please visit the MPS website under Quality Assurance. "MPS" and "The Future of Analog IC Technology" are registered trademarks of Monolithic Power Systems, Inc.

## TYPICAL APPLICATION

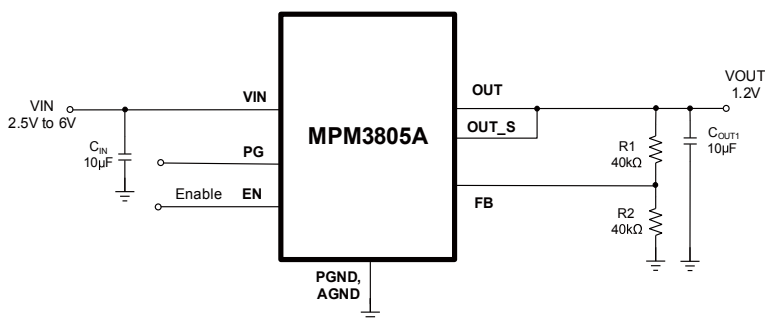

### Efficiency vs. Load

V<sub>OUT</sub> = 1.2V

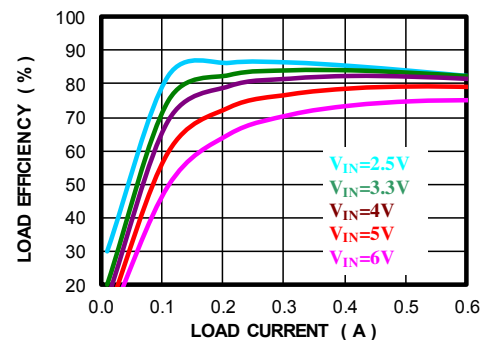

### ORDERING INFORMATION

| Part Number       | Package                    | Top Marking |
|-------------------|----------------------------|-------------|
| MPM3805AGQB-AEC1* | QFN-12 (2.5mmx3.0mmx0.9mm) | See Below   |
| MPM3805AGQBE-AEC1 |                            |             |

\* For Tape & Reel, add suffix -Z (e.g.: MPM3805AGQB-AEC1-Z).

#### TOP MARKING (MPM3805AGQB-AEC1)

BDZ  
YWW  
LLL

#### TOP MARKING (MPM3805AGQBE-AEC1)

BHP  
YWW  
LLL

BDZ: Product code of MPM3805AGQB-AEC1  
Y: Year code  
WW: Week code  
LLL: Lot number

BHP: Product code of MPM3805AGQBE-AEC1  
Y: Year code  
WW: Week code  
LLL: Lot number

### PACKAGE REFERENCE

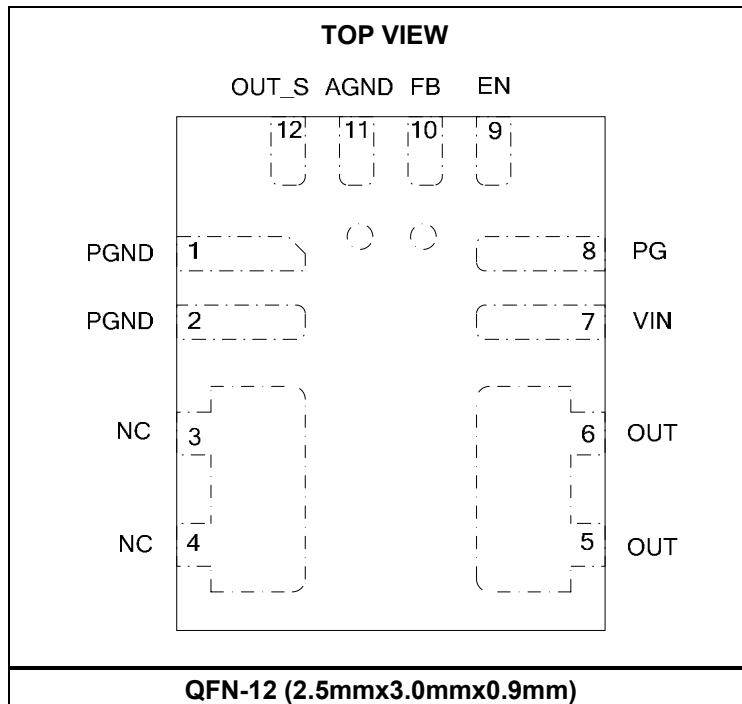



**PRELIMINARY SPECIFICATIONS SUBJECT TO CHANGE**

**ABSOLUTE MAXIMUM RATINGS <sup>(1)</sup>**

|  |   |
|--|---|
| Supply voltage ( $V_{IN}$ ) .....  | 6.5V  |
| $V_{SW}$ .....   | -0.3V (-5V for <10ns)<br>to 6.5V (7V for <10ns) |
| All other pins .....   | -0.3V to 6.5V                                   |
| Junction temperature .....   | 150°C   |
| Lead temperature.....  | 260°C   |
| Continuous power dissipation ( $T_A = +25^\circ\text{C}$ ) <sup>(2)</sup><br>..... | 1.9W  |
| Storage temperature .....  | -65°C to +150°C                                 |

**Recommended Operating Conditions**

|  |                            |
|--|----------------------------|
| Supply voltage ( $V_{IN}$ ) .....      | 2.6V to 6V                 |
| Output voltage ( $V_{OUT}$ ).....      | 12% x $V_{IN}$ to $V_{IN}$ |
| Operating junction temp. ( $T_J$ ).... | -40°C to +125°C            |

|  |               |               |          |
|--|---------------|---------------|----------|
| <b>Thermal Resistance <sup>(3)</sup></b> | $\theta_{JA}$ | $\theta_{JC}$ |          |
| QFN-12 (2.5mmx3.0mm).....                | 65            | 13            | ... °C/W |

**NOTES:**

- 1) Exceeding these ratings may damage the device.
- 2) The maximum allowable power dissipation is a function of the maximum junction temperature  $T_J$  (MAX), the junction-to-ambient thermal resistance  $\theta_{JA}$ , and the ambient temperature  $T_A$ . The maximum allowable continuous power dissipation at any ambient temperature is calculated by  $P_D$  (MAX) =  $(T_J$  (MAX)- $T_A$ )/ $\theta_{JA}$ . Exceeding the maximum allowable power dissipation produces an excessive die temperature, causing the device to go into thermal shutdown. Internal thermal shutdown circuitry protects the device from permanent damage.
- 3) Measured on JESD51-7, 4-layer PCB.

## ELECTRICAL CHARACTERISTICS

$V_{IN} = 5V$ ,  $T_J = -40^{\circ}C$  to  $+125^{\circ}C$ , unless otherwise noted. Typical values are at  $T_J = +25^{\circ}C$ .

| Parameter                                  | Symbol        | Condition   | Min  | Typ  | Max  | Units      |
|--|---------------|---|------|------|------|------------|
| Feedback voltage                           | $V_{FB}$      | $2.6V \leq V_{IN} \leq 6V$ , $T_J = +25^{\circ}C$                             | 588  | 600  | 612  | mV         |
|  |               | $2.6V \leq V_{IN} \leq 6V$ , $T_J = -40^{\circ}C$ to $+125^{\circ}C$          | 573  |      | 627  |            |
| Feedback current                           | $I_{FB}$      | $V_{FB} = 0.63V$  |      | 10   | 1000 | nA         |
| P-FET switch on resistance                 | $R_{DSON\_P}$ |   |      | 120  | 180  | m $\Omega$ |
| N-FET switch on resistance                 | $R_{DSON\_N}$ |   |      | 70   | 140  | m $\Omega$ |
| Inductor L value                           | L             | Inductance value at 1MHz  |      | 0.47 |      | $\mu H$    |
| Inductor DC resistance                     | $R_{DCR}$     |   |      | 130  |      | m $\Omega$ |
| Dropout resistance                         | $R_{DR}$      | 100% on duty  |      | 250  |      | m $\Omega$ |
| Switch leakage                             |               | $V_{EN} = 0V$ , $V_{IN} = 6V$ , $V_{SW} = 0V$ and $6V$ , $T_J = +25^{\circ}C$ |      | 0    | 1    | $\mu A$    |
| P-FET current limit                        |               | $T_J = +25^{\circ}C$  | 1.2  |      |      | A          |
|  |               | $T_J = -40^{\circ}C$ to $+125^{\circ}C$                                       | 1.0  |      |      |            |
| On time                                    | $T_{ON}$      | $V_{IN} = 5V$ , $V_{OUT} = 1.2V$  |      | 70   |      | ns         |
|  |               | $V_{IN} = 3.6V$ , $V_{OUT} = 1.2V$  |      | 100  |      |            |
| Switching frequency                        | $F_s$         | $V_{IN} = 3.6V$ , $V_{OUT} = 1.2V$  | 2800 | 3500 | 4200 | kHz        |
| Minimum off time                           | $T_{MIN-OFF}$ |   |      | 60   |      | ns         |
| Soft-start time                            | $T_{SS-ON}$   |   |      | 1.5  |      | ms         |
| Power good upper trip threshold            | $PG_H$        | FB voltage in respect to the regulation                                       |      | +10  |      | %          |
| Power good lower trip threshold            | $PG_L$        |   |      | -10  |      | %          |
| Power good delay                           | $PG_D$        |   |      | 50   |      | $\mu s$    |
| Power good sink current capability         | $V_{PG-L}$    | Sink 1mA  |      |      | 0.4  | V          |
| Power good logic high voltage              | $V_{PG-H}$    | $V_{IN} = 5V$ , $V_{FB} = 0.6V$   | 4.7  |      |      | V          |
| Power good internal pull-up resistor       | $R_{PG}$      |   |      | 550  |      | k $\Omega$ |
| Under-voltage lockout threshold rising     |               |   | 2.2  | 2.4  | 2.58 | V          |
| Under-voltage lockout threshold hysteresis |               |   |      | 300  |      | mV         |
| EN input logic low voltage                 |               |   |      |      | 0.4  | V          |
| EN input logic high voltage                |               |   | 1.2  |      |      | V          |
| EN input current                           |               | $V_{EN} = 2V$   |      | 1.5  |      | $\mu A$    |
|  |               | $V_{EN} = 0V$   |      | 0.1  | 1    |            |

**ELECTRICAL CHARACTERISTICS (continued)**
 $V_{IN} = 5V$ ,  $T_J = -40^{\circ}C$  to  $+125^{\circ}C$ , unless otherwise noted. Typical values are at  $T_J = +25^{\circ}C$ .

| Parameter                         | Symbol | Condition  | Min | Typ | Max | Units       |
|-----------------------------------|--------|--|-----|-----|-----|-------------|
| Supply current (shutdown)         |        | $V_{EN} = 0V$ , $T_J = +25^{\circ}C$   |     |     | 1   | $\mu A$     |
|                                   |        | $V_{EN} = 0V$ , $T_J = -40^{\circ}C$ to $+125^{\circ}C$                                    |     |     | 10  |             |
| Supply current (quiescent)        |        | $V_{EN} = 2V$ , $V_{FB} = 0.63V$ , $V_{IN} = 5V$ , $T_J = +25^{\circ}C$                    |     | 485 | 560 | $\mu A$     |
|                                   |        | $V_{EN} = 2V$ , $V_{FB} = 0.63V$ , $V_{IN} = 5V$ , $T_J = -40^{\circ}C$ to $+125^{\circ}C$ |     |     | 580 |             |
| Thermal shutdown <sup>(4)</sup>   |        |  |     | 150 |     | $^{\circ}C$ |
| Thermal hysteresis <sup>(4)</sup> |        |  |     | 30  |     | $^{\circ}C$ |

**NOTE:**

4) Not tested in production, guaranteed by design.

## TYPICAL PERFORMANCE CHARACTERISTICS

$V_{IN} = 5V$ ,  $V_{OUT} = 1.2V$ ,  $C_{IN} = 10\mu F$ ,  $C_{OUT} = 20\mu F$ ,  $T_A = +25^\circ C$ , unless otherwise noted.

Shutdown Current vs.  $V_{IN}$

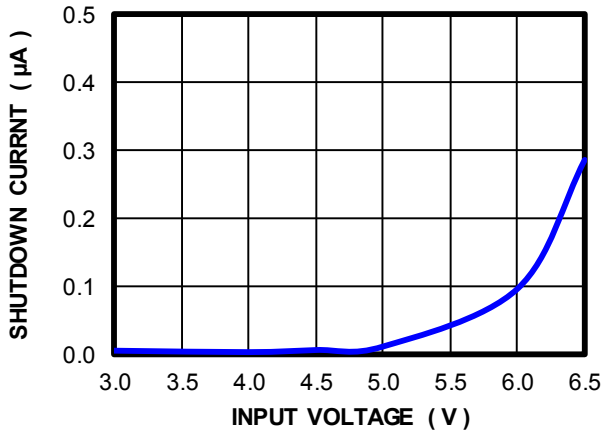

Maximum  $I_{OUT}$  vs. Ambient Temperature

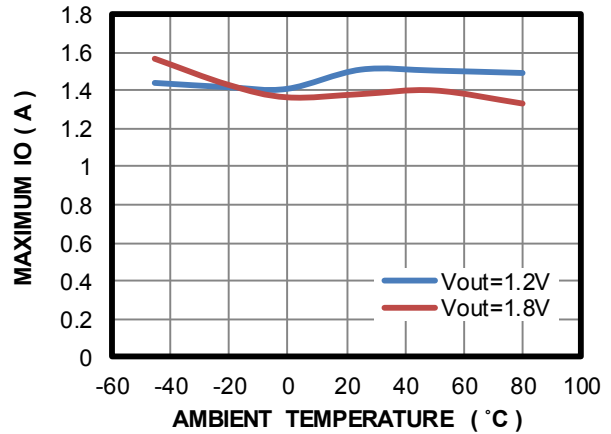

Output Current Derating vs. Output Voltage

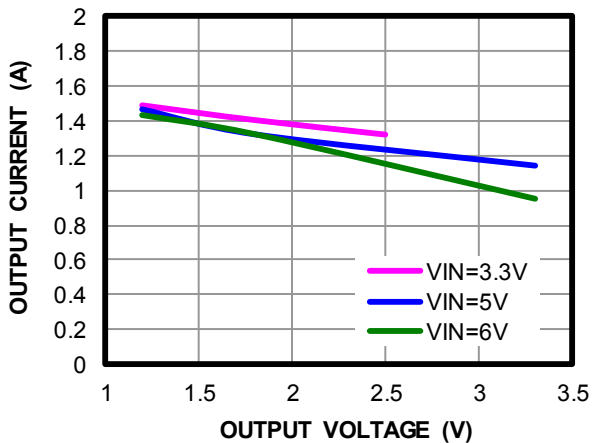

Efficiency vs. Load

$V_{OUT} = 1.2V$

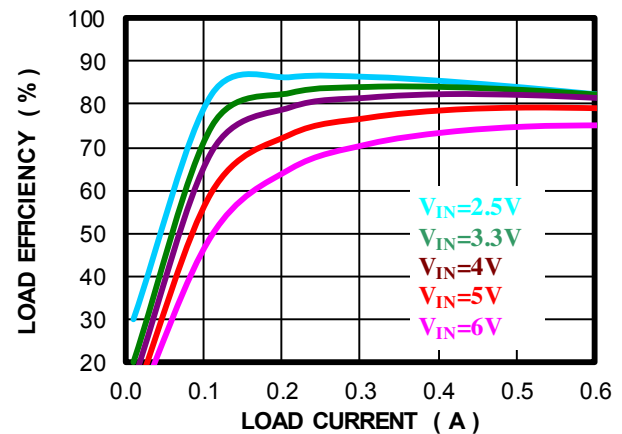

Efficiency vs. Line

$V_{OUT} = 1.2V$

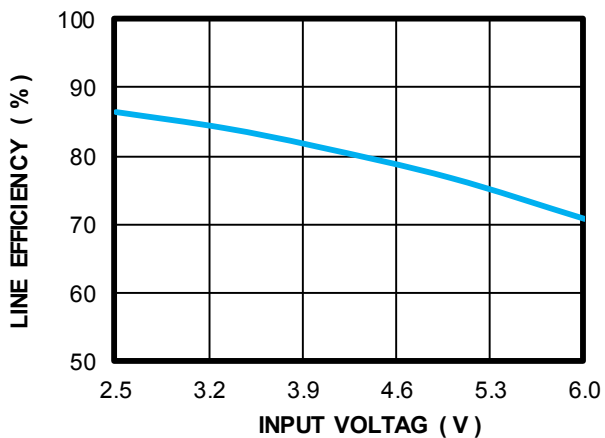

Load Regulation

$V_{OUT} = 1.2V$

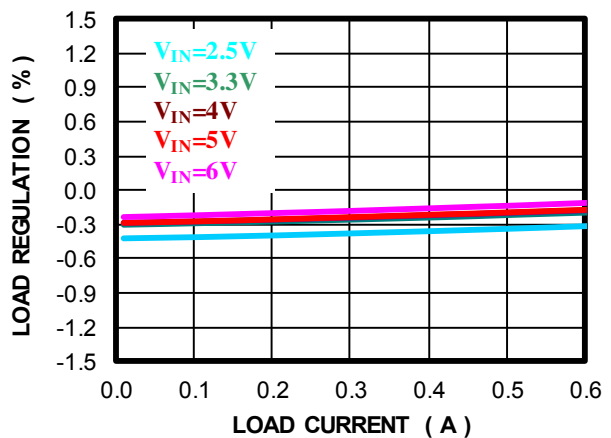

### TYPICAL PERFORMANCE CHARACTERISTICS (continued)

$V_{IN} = 5V$ ,  $C_{IN} = 10\mu F$ ,  $C_{OUT} = 20\mu F$ ,  $T_A = +25^\circ C$ , unless otherwise noted.

**Line Regulation**

$V_{OUT} = 1.2V$

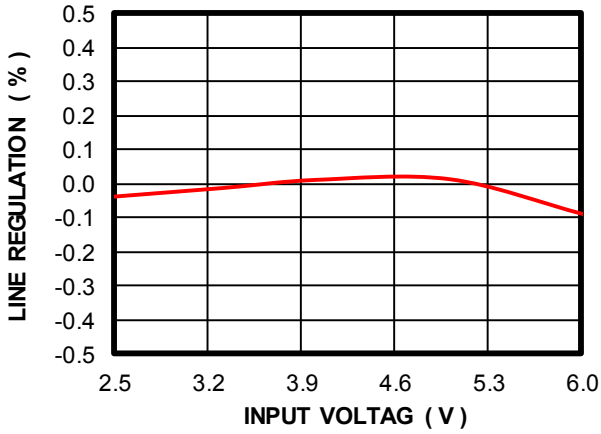

**Efficiency vs. Load**

$V_{OUT} = 1.8V$

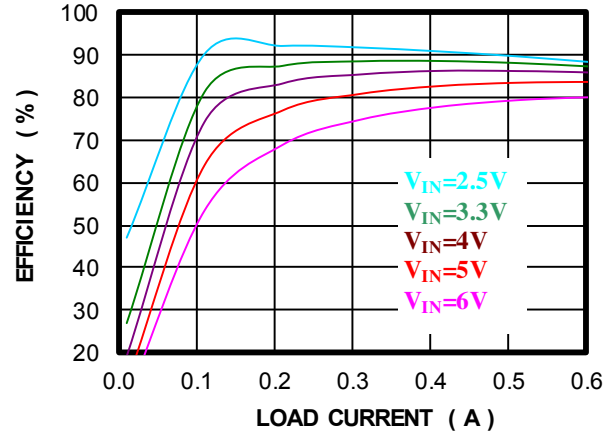

**Efficiency vs. Line**

$V_{OUT} = 1.8V$

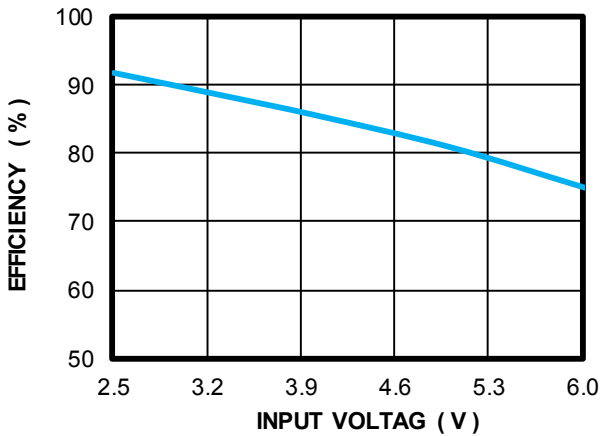

**Load Regulation**

$V_{OUT} = 1.8V$

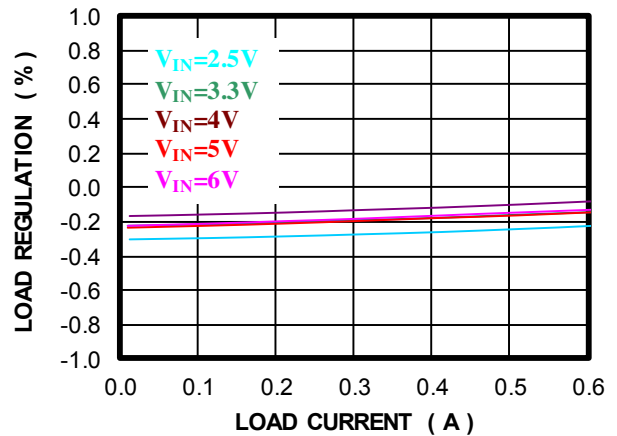

**Line Regulation**

$V_{OUT} = 1.8V$

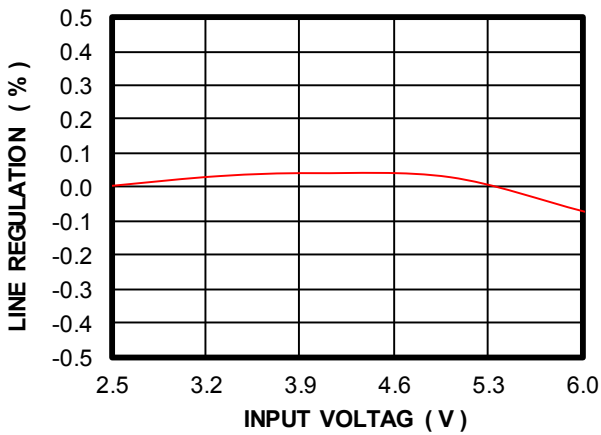

### TYPICAL PERFORMANCE CHARACTERISTICS (continued)

$V_{IN} = 5V$ ,  $V_{OUT} = 1.2V$ ,  $C_{IN} = 10\mu F$ ,  $C_{OUT} = 20\mu F$ ,  $T_A = +25^\circ C$ , unless otherwise noted.

PFET Current Limit vs.  $T_A$

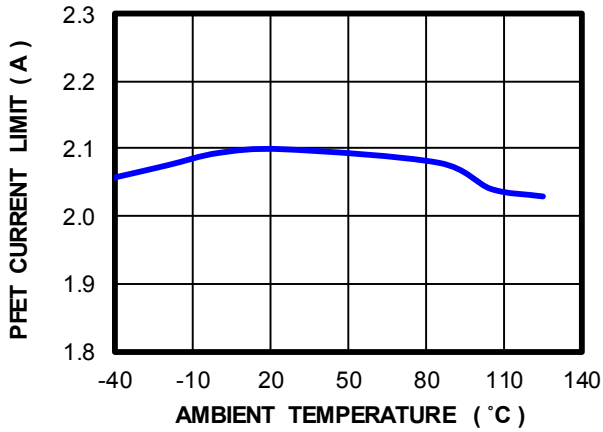

Switch Frequency vs.  $T_A$

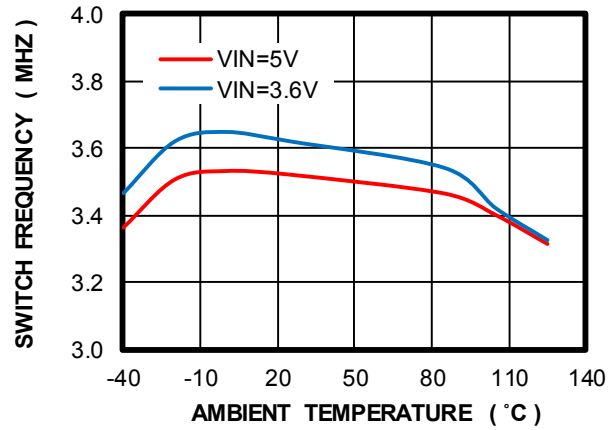

Enable On/Off vs.  $T_A$

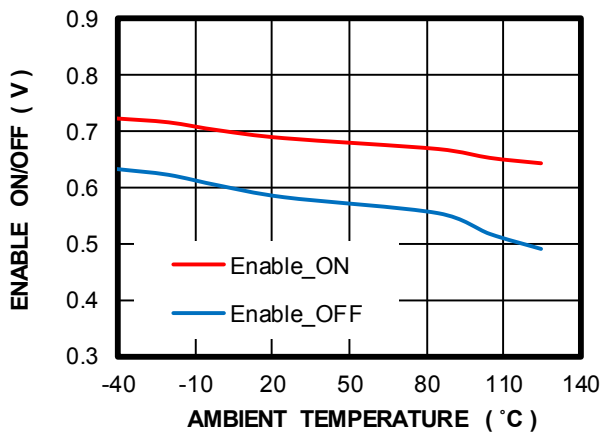

Feedback Voltage vs.  $T_A$

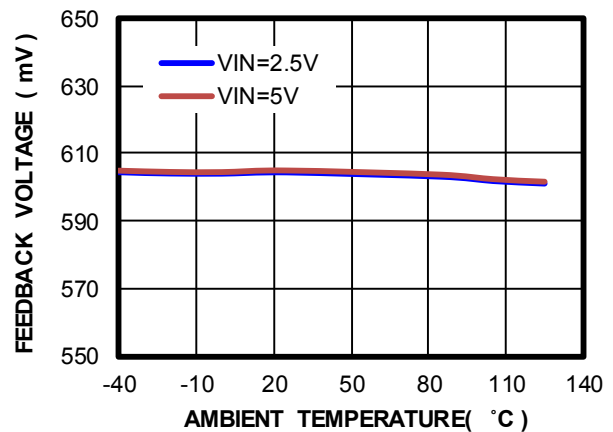

Supply Current vs.  $T_A$

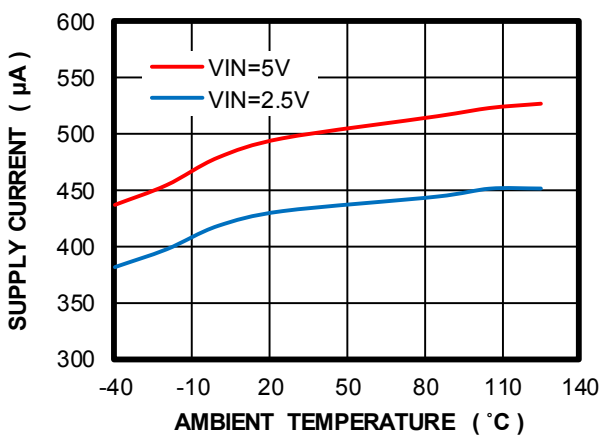



**TYPICAL PERFORMANCE CHARACTERISTICS (continued)**

$V_{IN} = 5V$ ,  $C_{IN} = 10\mu F$ ,  $C_{OUT} = 20\mu F$ ,  $T_A = +25^\circ C$ , unless otherwise noted.

**Steady State**

$V_{IN} = 5V$ ,  $V_{OUT} = 1.2V$ ,  $I_{OUT} = 0.1A$

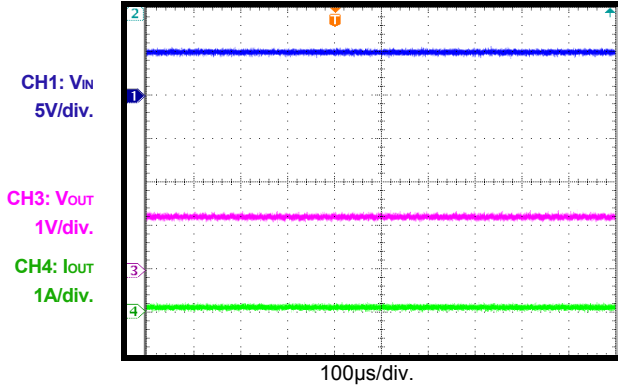

**Steady State**

$V_{IN} = 5V$ ,  $V_{OUT} = 1.2V$ ,  $I_{OUT} = 0.3A$

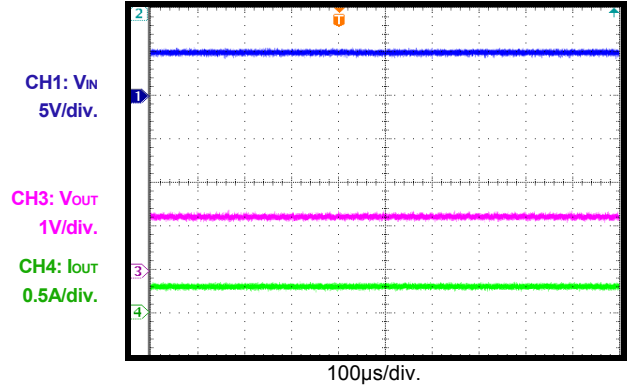

**Steady State**

$V_{IN} = 5V$ ,  $V_{OUT} = 1.2V$ ,  $I_{OUT} = 0.6A$

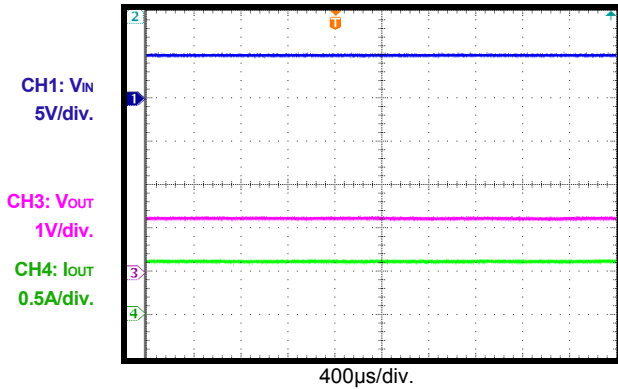

**Steady State**

$V_{IN} = 5V$ ,  $V_{OUT} = 1.8V$ ,  $I_{OUT} = 0.1A$

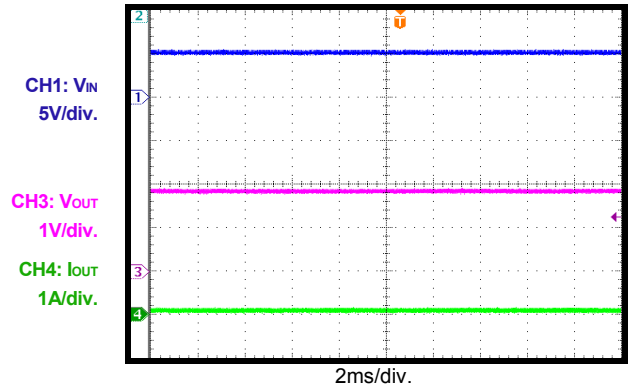

**Steady State**

$V_{IN} = 5V$ ,  $V_{OUT} = 1.8V$ ,  $I_{OUT} = 0.6A$

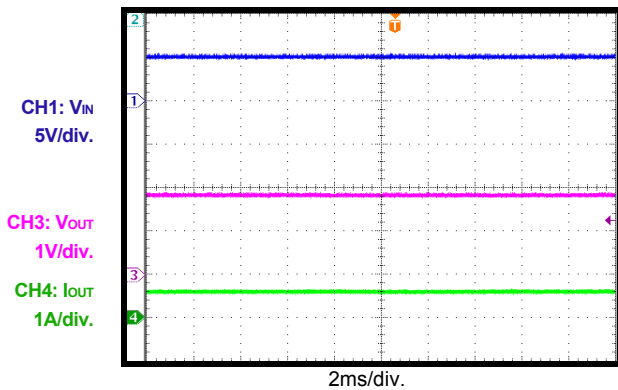

**Steady State**

$V_{IN} = 5V$ ,  $V_{OUT} = 1.8V$ ,  $I_{OUT} = 0.6A$

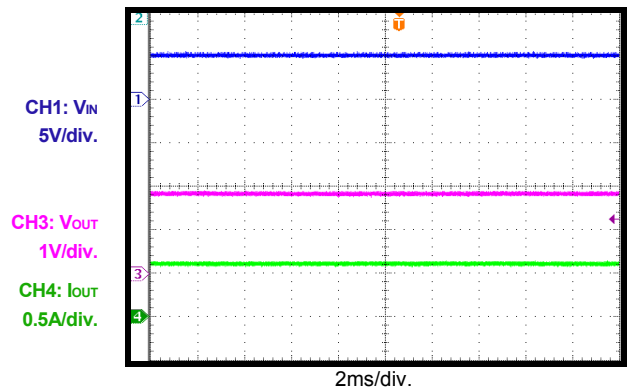

### TYPICAL PERFORMANCE CHARACTERISTICS (continued)

$V_{IN} = 5V$ ,  $C_{IN} = 10\mu F$ ,  $C_{OUT} = 20\mu F$ ,  $T_A = +25^\circ C$ , unless otherwise noted.

#### Power Up

$V_{IN} = 2.5V$ ,  $V_{OUT} = 1.2V$ ,  $I_{OUT} = 0.6A$

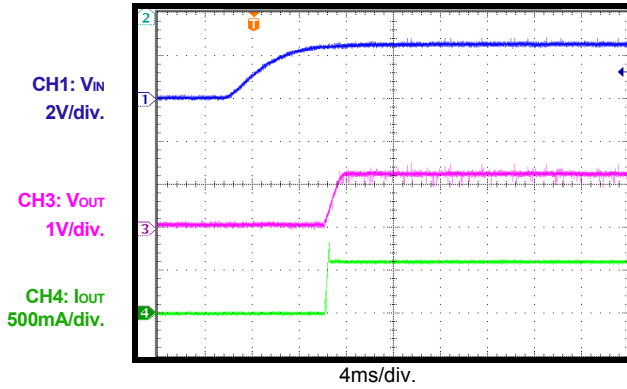

#### Power Down

$V_{IN} = 2.5V$ ,  $V_{OUT} = 1.2V$ ,  $I_{OUT} = 0.6A$

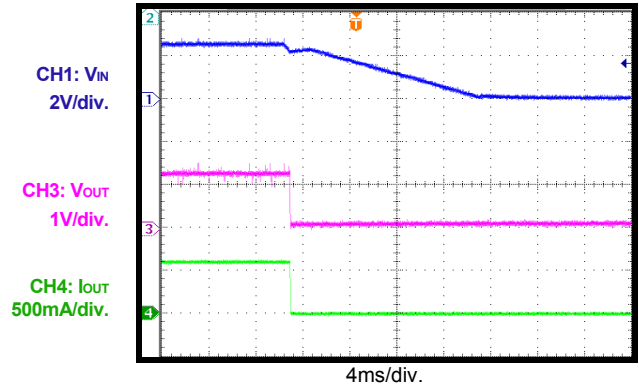

#### Power Up

$V_{IN} = 3.3V$ ,  $V_{OUT} = 1.8V$ ,  $I_{OUT} = 0.6A$

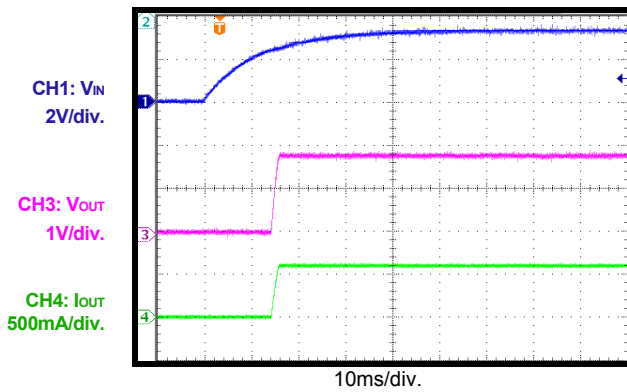

#### Power Down

$V_{IN} = 3.3V$ ,  $V_{OUT} = 1.8V$ ,  $I_{OUT} = 0.6A$

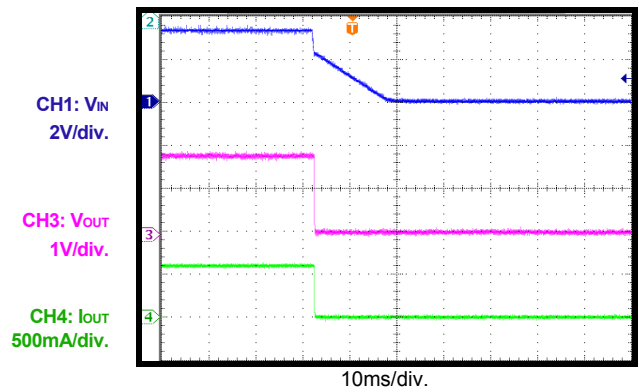

#### Enable On

$V_{IN} = 2.5V$ ,  $V_{OUT} = 1.2V$ ,  $I_{OUT} = 0.6A$

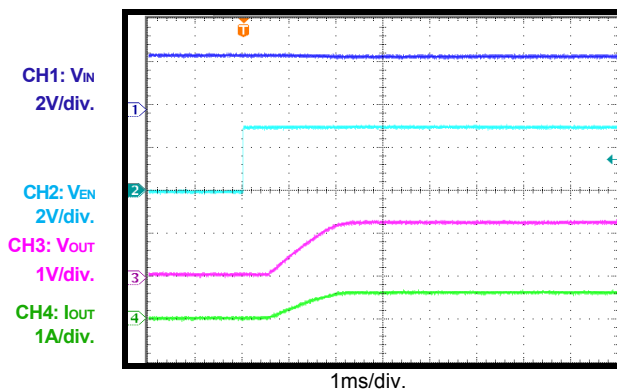

#### Enable Off

$V_{IN} = 2.5V$ ,  $V_{OUT} = 1.2V$ ,  $I_{OUT} = 0.6A$

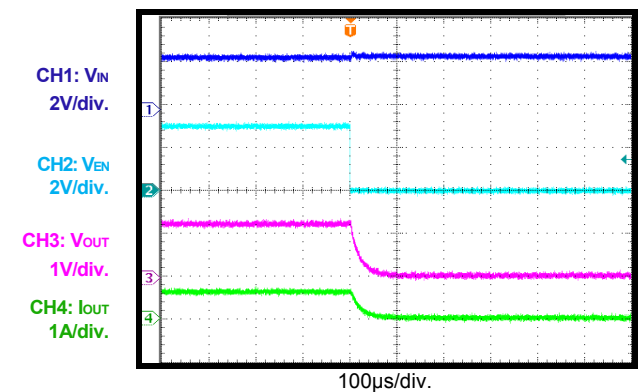

### TYPICAL PERFORMANCE CHARACTERISTICS (continued)

$V_{IN} = 5V$ ,  $C_{IN} = 10\mu F$ ,  $C_{OUT} = 20\mu F$ ,  $T_A = +25^\circ C$ , unless otherwise noted.

#### Enable On

$V_{IN} = 3.3V$ ,  $V_{OUT} = 1.8V$ ,  $I_{OUT} = 0.6A$

CH1:  $V_{IN}$   
2V/div.  
CH2:  $V_{EN}$   
5V/div.  
CH3:  $V_{OUT}$   
2V/div.  
CH4:  $I_{OUT}$   
500mA/div.

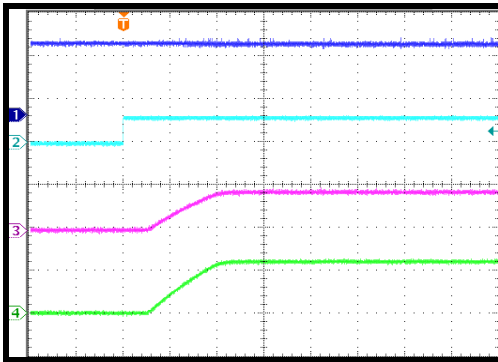

#### Enable Off

$V_{IN} = 3.3V$ ,  $V_{OUT} = 1.8V$ ,  $I_{OUT} = 0.6A$

CH1:  $V_{IN}$   
2V/div.  
CH2:  $V_{EN}$   
5V/div.  
CH3:  $V_{OUT}$   
2V/div.  
CH4:  $I_{OUT}$   
500mA/div.

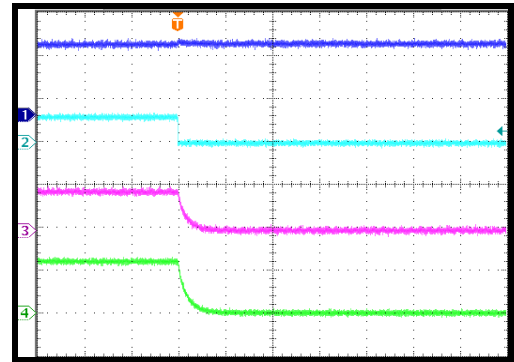

#### Steady State

$V_{IN} = 5V$ ,  $V_{OUT} = 1.8V$ ,  $I_{OUT} = 0.6A$

CH1:  $V_{IN}$   
5V/div.  
CH3:  $V_{OUT}$   
1V/div.  
CH4:  $I_{OUT}$   
1A/div.

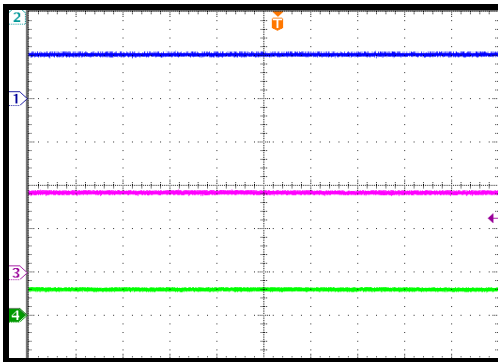

#### Steady State

$V_{IN} = 5V$ ,  $V_{OUT} = 1.2V$ ,  $I_{OUT} = 0.6A$

CH1:  $V_{IN}$   
5V/div.  
CH3:  $V_{OUT}$   
1V/div.  
CH4:  $I_{OUT}$   
1A/div.

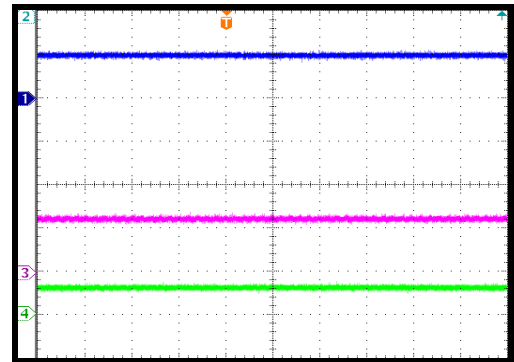

#### Short Circuit

$V_{IN} = 5V$ ,  $V_{OUT} = 1.2V$

CH1:  $V_{IN}$   
5V/div.  
CH3:  $V_{OUT}$   
1V/div.  
CH4:  $I_{IN}$   
1A/div.

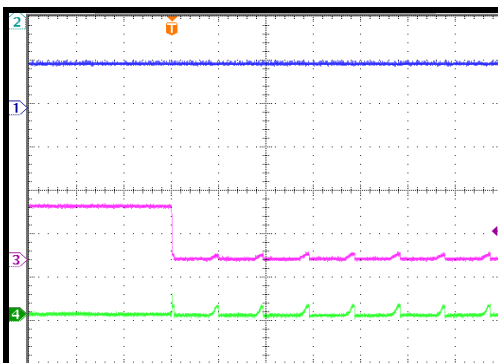

#### Short-Circuit Recovery

$V_{IN} = 5V$ ,  $V_{OUT} = 1.2V$

CH1:  $V_{IN}$   
5V/div.  
CH3:  $V_{OUT}$   
1V/div.  
CH4:  $I_{IN}$   
1A/div.

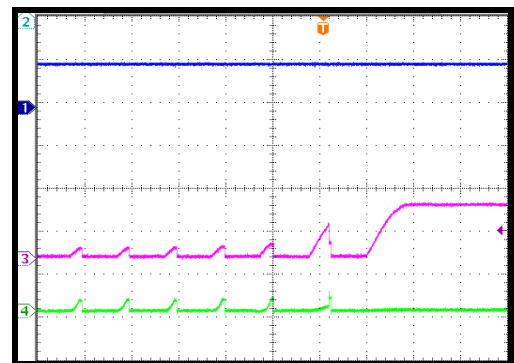

### TYPICAL PERFORMANCE CHARACTERISTICS (continued)

$V_{IN} = 5V$ ,  $C_{IN} = 10\mu F$ ,  $C_{OUT} = 20\mu F$ ,  $T_A = +25^\circ C$ , unless otherwise noted.

#### Short-Circuit Entry

$V_{IN} = 5V$ ,  $V_{OUT} = 1.8V$

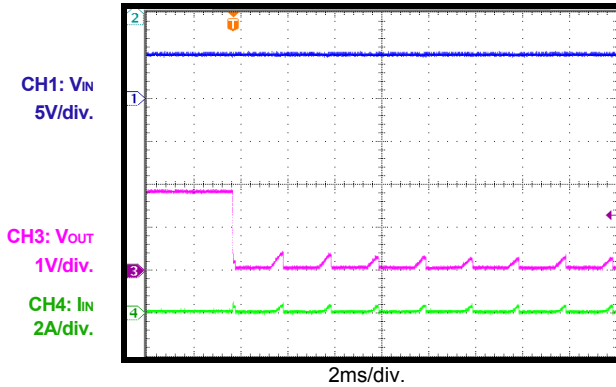

#### Short Circuit

$V_{IN} = 5V$ ,  $V_{OUT} = 1.8V$

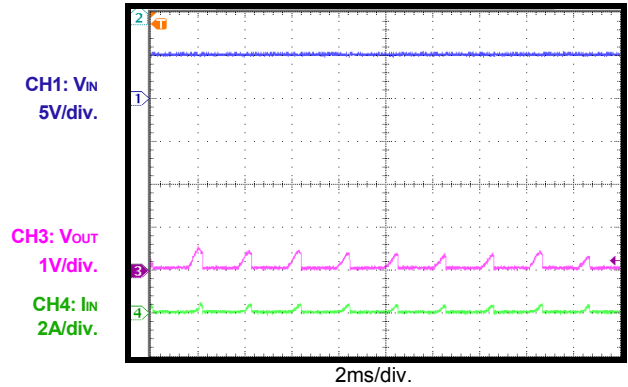

#### Short-Circuit Recovery

$V_{IN} = 5V$ ,  $V_{OUT} = 1.2V$

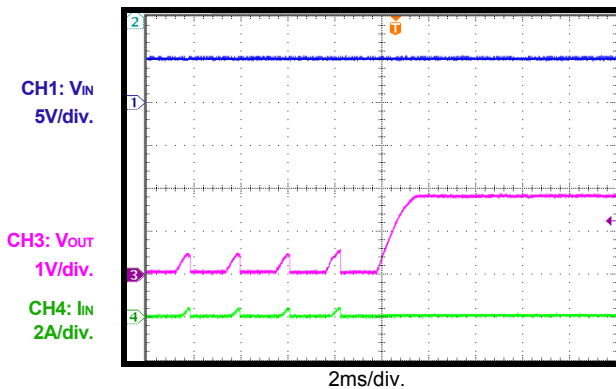

#### Transient Response

$V_{IN} = 2.5V$ ,  $V_{OUT} = 1.2V$ ,  $I_{OUT} = 0 - 0.6A$ ,  $0.25A/\mu s$

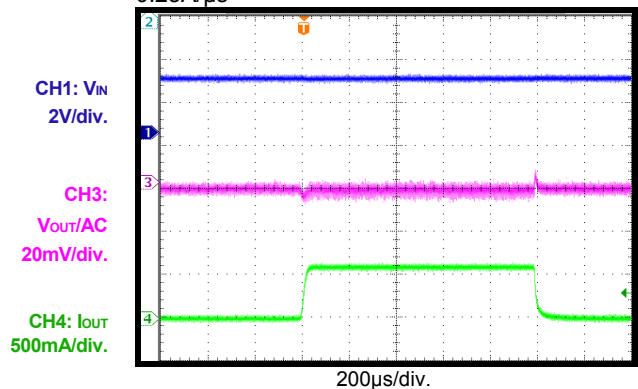

#### Transient Response

$V_{IN} = 3.3V$ ,  $V_{OUT} = 1.2V$ ,  $I_{OUT} = 0 - 0.6A$ ,  $0.25A/\mu s$

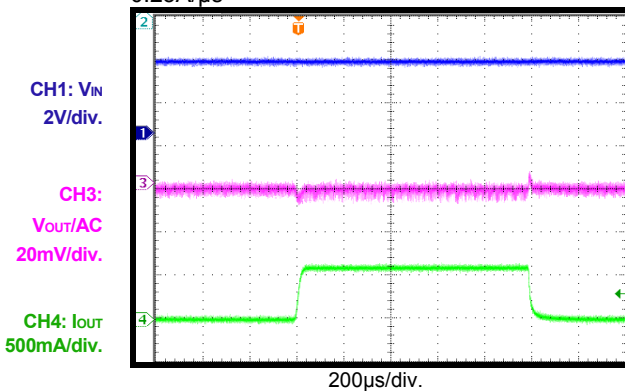

#### Transient Response

$V_{IN} = 6V$ ,  $V_{OUT} = 1.2V$ ,  $I_{OUT} = 0 - 0.6A$ ,  $0.25A/\mu s$

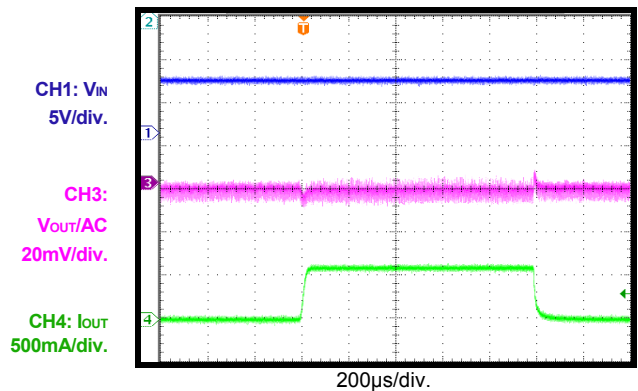

### TYPICAL PERFORMANCE CHARACTERISTICS (continued)

$V_{IN} = 5V$ ,  $C_{IN} = 10\mu F$ ,  $C_{OUT} = 20\mu F$ ,  $T_A = +25^\circ C$ , unless otherwise noted.

#### Transient Response

$V_{IN} = 2.5V$ ,  $V_{OUT} = 1.8V$ ,  $I_{OUT} = 0 - 0.6A$ ,  $0.25A/\mu s$

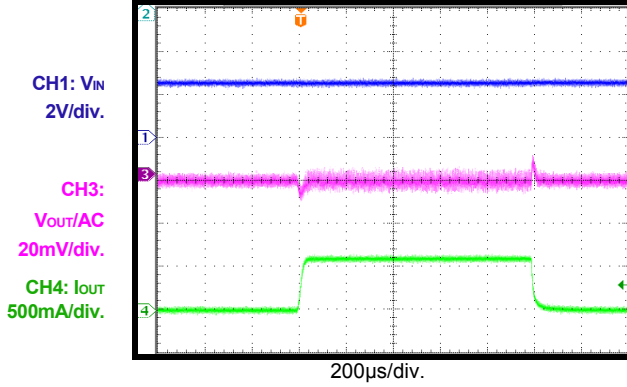

#### Transient Response

$V_{IN} = 3.3V$ ,  $V_{OUT} = 1.8V$ ,  $I_{OUT} = 0 - 0.6A$ ,  $0.25A/\mu s$

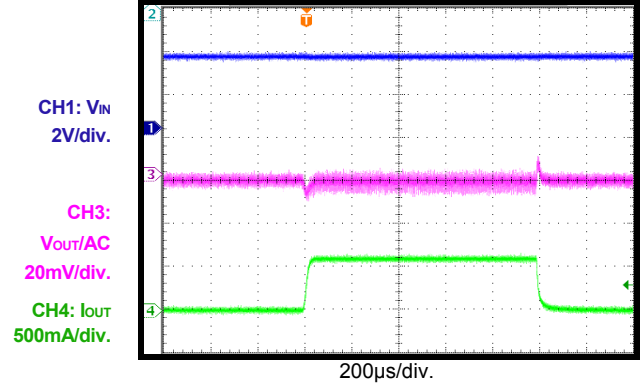

#### Transient Response

$V_{IN} = 6V$ ,  $V_{OUT} = 1.8V$ ,  $I_{OUT} = 0 - 0.6A$ ,  $0.25A/\mu s$

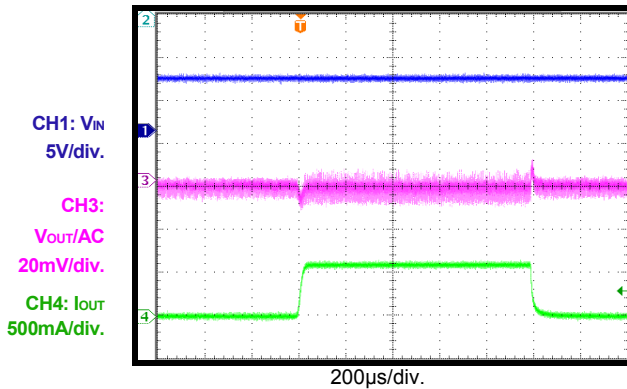

## PIN FUNCTIONS

| Pin # | Name  | Description  |
|-------|-------|--|
| 1, 2  | PGND  | <b>Power ground.</b>   |
| 3, 4  | NC    | <b>Internal SW pad.</b>  |
| 5, 6  | OUT   | <b>Output voltage power rail.</b> Connect the load to OUT. An output capacitor is required on OUT.   |
| 7     | VIN   | <b>Supply voltage.</b> The MPM3805A operates from a +2.6V to +6V unregulated input. A decoupling capacitor is needed to prevent large voltage spikes from appearing at the input. Place the decoupling capacitor as close to VIN as possible.            |
| 8     | PG    | <b>Power good indicator.</b> The output of PG is an open drain with an internal pull-up resistor to VIN. PG is pulled up to VIN when the FB voltage is within 10% of the regulation level. If the FB voltage is out of that regulation range, PG is low. |
| 9     | EN    | <b>On/off control.</b>   |
| 10    | FB    | <b>Feedback.</b> An external resistor divider from the output to GND tapped to FB sets the output voltage.   |
| 11    | AGND  | <b>Analog ground for the internal control circuit.</b>   |
| 12    | OUT_S | <b>Output voltage sense.</b>   |

**BLOCK DIAGRAM**

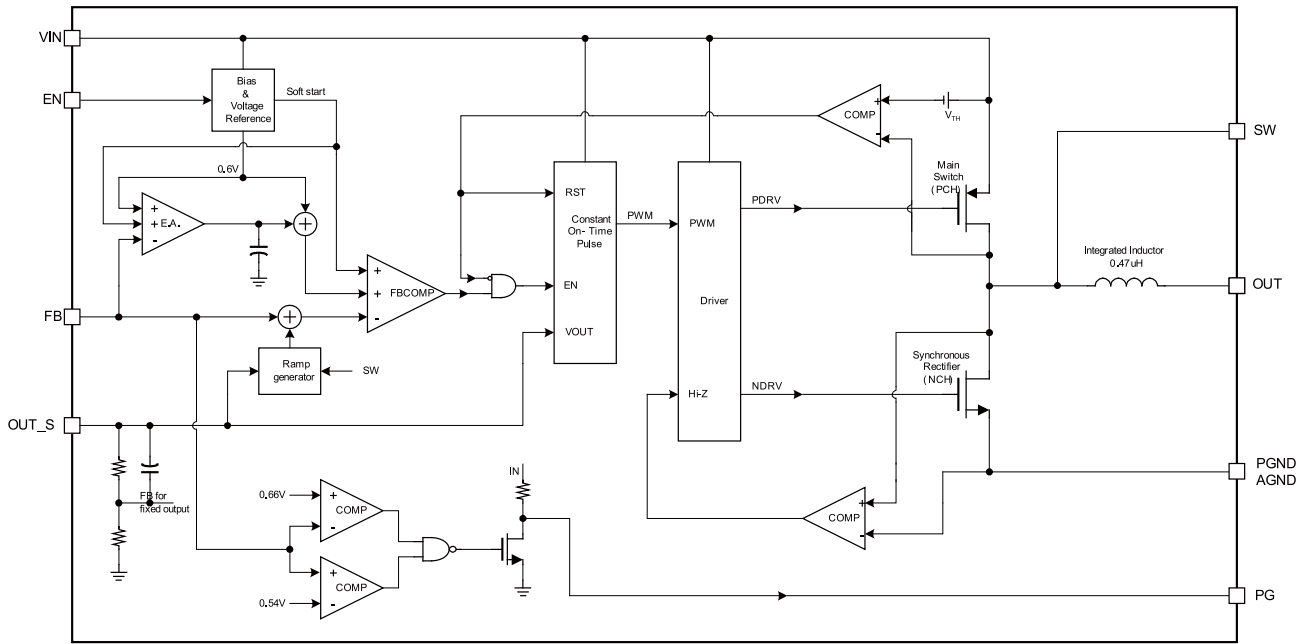

**Figure 1: Functional Block Diagram**

## OPERATION

The MPM3805A is available in a small, surface-mounted QFN-12 (2.5mmx3.0mmx0.9mm) package. The module's integrated inductor simplifies the schematic and layout design. Only FB resistors and input and output capacitors are required to complete the design. The MPM3805A uses constant-on-time (COT) control with input voltage feed-forward to stabilize the switching frequency over the entire input range. At light load, the MPM3805A employs proprietary control of the low-side switch and inductor current to improve efficiency.

### Constant-On-Time Control (COT)

Compared to fixed-frequency pulse-width modulation (PWM) control, COT control offers the advantage of a simpler control loop and faster transient response. By using the input voltage feed-forward, the MPM3805A maintains a nearly constant switching frequency across the input and output voltage ranges. The on time of the switching pulse can be estimated with Equation (1):

$$T_{ON} = \frac{V_{OUT}}{V_{IN}} \cdot 0.28\mu s \quad (1)$$

To prevent inductor current run-away during the load transition, the MPM3805A fixes the minimum off time to 60ns. This minimum off-time limit does not affect operation in steady state.

The MPM3805A works in forced continuous conduction mode (FCCM).

### Enable (EN)

If the input voltage is greater than the under-voltage lockout (UVLO) threshold (typically 2.3V), the MPM3805A is enabled by pulling EN above 1.2V. Float EN or pull EN down to ground to disable the MPM3805A. There is an internal 1MΩ resistor from EN to ground.

### Soft Start (SS)

The MPM3805A has a built-in soft start that ramps up the output voltage at a controlled slew rate. This prevents an overshoot during start-up. The soft-start time is about 1.5ms, typically.

### Power Good Indicator (PG)

The MPM3805A has an open drain pin with a 550kΩ pull-up resistor for power good indication (PG). When the feedback voltage ( $V_{FB}$ ) is within  $\pm 10\%$  of the regulation voltage (e.g.: 0.6V), PG is pulled up to  $V_{IN}$  by the internal resistor. If  $V_{FB}$  is out of the  $\pm 10\%$  window, PG is pulled down to ground by an internal MOSFET. The MOSFET has a maximum  $R_{DS(ON)}$  of less than 400Ω.

### Current Limit

The MPM3805A has a typical 2.1A current limit for the high-side switch. When the high-side switch reaches the current limit, the MPM3805A triggers the hiccup threshold until the current decreases. This prevents the inductor current from continuing to rise and damaging the components.

### Short Circuit and Recovery

The MPM3805A enters short-circuit protection (SCP) when the current limit is reached and attempts to recover with hiccup mode. In SCP, the MPM3805A disables the output power stage, discharges the soft-start capacitor, and attempts to soft start again automatically. If the short-circuit condition remains after the soft start ends, the MPM3805A repeats the cycle until the short circuit disappears, and the output rises back to the regulation level.



## APPLICATION INFORMATION

### Setting the Output Voltage

The external resistor divider is used to set the output voltage (see the Typical Application Circuit on page 19). The feedback resistor (R1) cannot be too large or too small considering the trade-off for stability and dynamics. Set R1 to be between 40 - 80kΩ. Then calculate R2 with Equation (2):

$$R2 = \frac{R1}{\frac{V_{out}}{0.6} - 1} \quad (2)$$

The feedback circuit is shown in Figure 2.

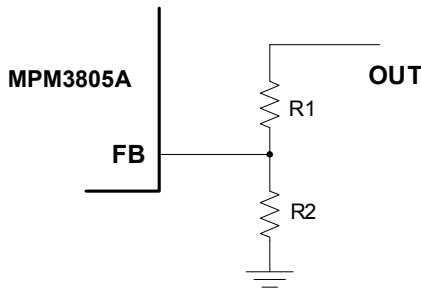

**Figure 2: Feedback Network**

Table 1 lists the recommended resistor values for common output voltages.

**Table 1: Resistor Values for Common Output Voltages**

| V <sub>OUT</sub> (V) | R1 (kΩ) | R2 (kΩ)   |
|----------------------|---------|-----------|
| 1.0                  | 40 (1%) | 60 (1%)   |
| 1.2                  | 40 (1%) | 40 (1%)   |
| 1.8                  | 60 (1%) | 30 (1%)   |
| 2.5                  | 80 (1%) | 25 (1%)   |
| 3.3                  | 80 (1%) | 17.7 (1%) |

### Selecting the Input Capacitor

The input current to the step-down converter is discontinuous and therefore requires a capacitor to supply AC current while maintaining the DC input voltage. For optimal performance, use low ESR capacitors. Ceramic capacitors with X5R or X7R dielectrics are highly recommended due to their low ESR and small temperature coefficients. For most applications, a 10μF capacitor is sufficient.

For higher output voltages, a 22μF capacitor may be needed to enhance system stability.

Since the input capacitor absorbs the input switching current, it requires an adequate ripple current rating. The RMS current in the input capacitor can be estimated with Equation (3):

$$I_{C1} = I_{LOAD} \times \sqrt{\frac{V_{OUT}}{V_{IN}} \times \left(1 - \frac{V_{OUT}}{V_{IN}}\right)} \quad (3)$$

The worst-case condition occurs at V<sub>IN</sub> = 2V<sub>OUT</sub>, shown in Equation (4):

$$I_{C1} = \frac{I_{LOAD}}{2} \quad (4)$$

For simplification, choose an input capacitor with an RMS current rating greater than half of the maximum load current.

The input capacitor can be electrolytic, tantalum, or ceramic. When using electrolytic or tantalum capacitors, place a small, high-quality, ceramic capacitor (i.e.: 0.1μF) as close to the IC as possible. When using ceramic capacitors, ensure that they have enough capacitance to provide a sufficient charge to prevent an excessive voltage ripple at the input. The input-voltage ripple caused by the capacitance can be estimated with Equation (5):

$$\Delta V_{IN} = \frac{I_{LOAD}}{f_s \times C1} \times \frac{V_{OUT}}{V_{IN}} \times \left(1 - \frac{V_{OUT}}{V_{IN}}\right) \quad (5)$$

### Selecting the Output Capacitor

An output capacitor (C<sub>OUT</sub>) is required to maintain the DC output voltage. Low ESR, ceramic capacitors are recommended to keep the output voltage ripple low. The output voltage ripple is estimated with Equation (6):

$$\Delta V_{OUT} = \frac{V_{OUT}}{f_s \times L_1} \times \left(1 - \frac{V_{OUT}}{V_{IN}}\right) \times \left(R_{ESR} + \frac{1}{8 \times f_s \times C2}\right) \quad (6)$$

Where L<sub>1</sub> is the inductor value (0.47μH), and R<sub>ESR</sub> is the equivalent series resistance (ESR) value of the output capacitor.

When using ceramic capacitors, the impedance at the switching frequency is dominated by the capacitance. The output voltage ripple is caused mainly by the capacitance. For simplification, the output voltage ripple can be estimated with Equation (7):

$$\Delta V_{OUT} = \frac{V_{OUT}}{8 \times f_s^2 \times L_1 \times C_2} \times \left( 1 - \frac{V_{OUT}}{V_{IN}} \right) \quad (7)$$

When using tantalum or electrolytic capacitors, the ESR dominates the impedance at the switching frequency. For simplification, the output ripple can be approximated with Equation (8):

$$\Delta V_{OUT} = \frac{V_{OUT}}{f_s \times L_1} \times \left( 1 - \frac{V_{OUT}}{V_{IN}} \right) \times R_{ESR} \quad (8)$$

The characteristics of the output capacitor affect the stability of the regulation system.

### PCB Layout Guidelines

Efficient PCB layout is critical for stable operation. The module's integrated inductor simplifies the schematic and layout design. Only FB resistors and input and output capacitors are needed to complete the design. For best results, refer to Figure 3 and follow the guidelines below.

1. Place the high-current paths (PGND, VIN, and OUT) very close to the device with short, direct, and wide traces.
2. Place the input capacitor as close to VIN and PGND as possible.
3. Place the external feedback resistors next to FB.
4. Keep the switching node away from the feedback network.

For additional device applications, please refer to the related evaluation board datasheets (EVB).

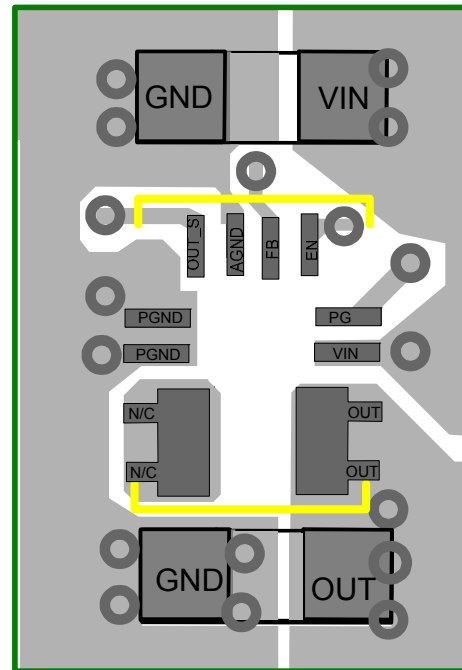

**Top View**

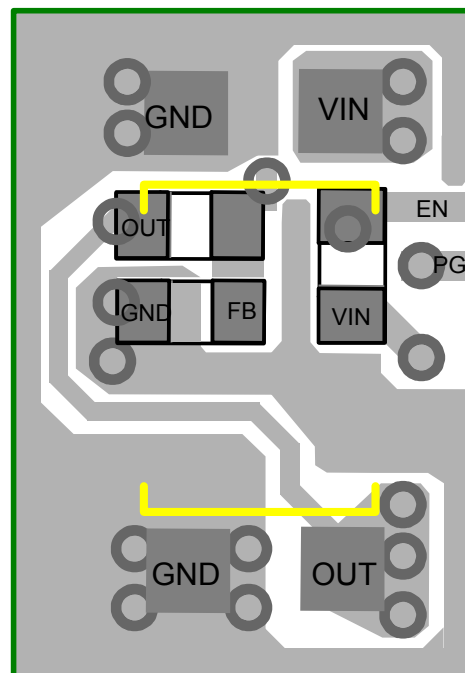

**Bottom View**

**Figure 3: Recommended Layout**

**TYPICAL APPLICATION CIRCUIT**

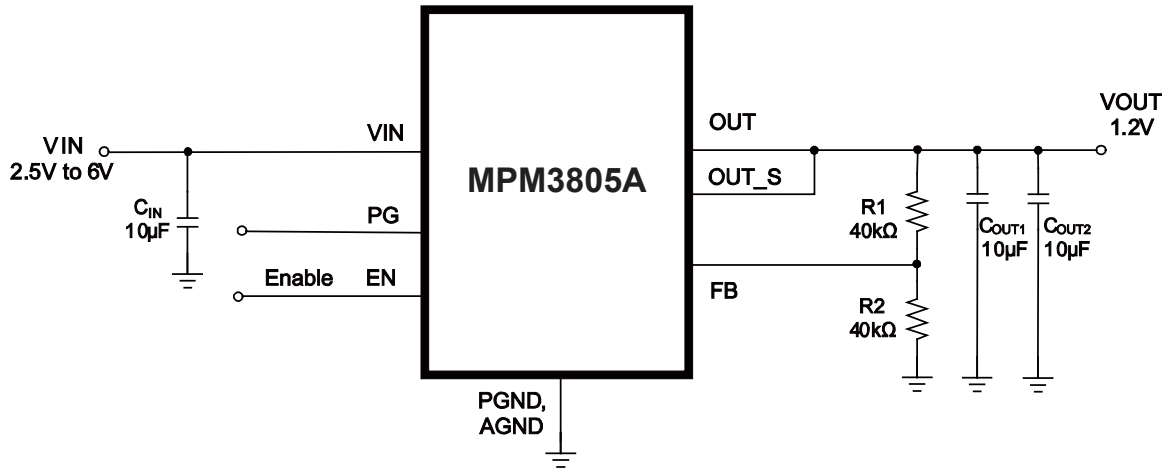
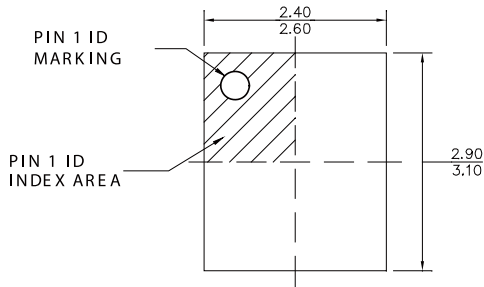

Figure 4: Typical Application Circuits

## PACKAGE INFORMATION

### QFN-12 (2.5mmx3.0mmx0.9mm)



TOP VIEW

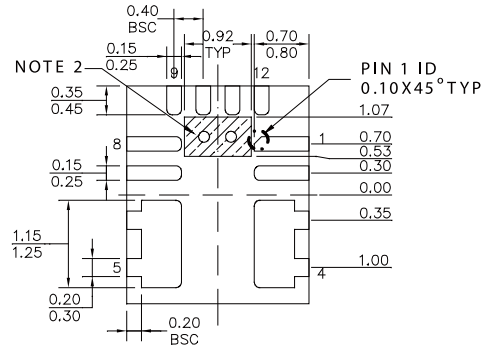

BOTTOM VIEW

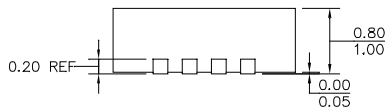

SIDE VIEW

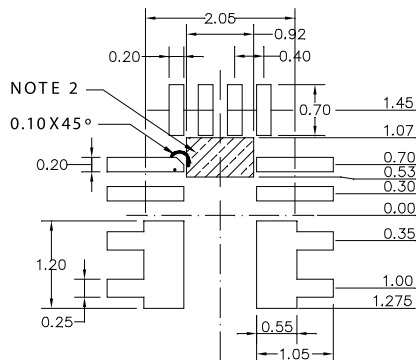

RECOMMENDED LAND PATTERN

#### NOTE:

- 1) ALL DIMENSIONS ARE IN MILLIMETERS
- 2) SHADED AREA IS THE KEEPOUT ZONE. THE EXPOSED BOTTOM METAL PADS ENCLOSED BY THIS ZONE IS NOT TO BE CONNECTED TO ANY PCB METAL TRACE & VIA ELECTRICALLY OR MECHANICALLY.
- 3) EXPOSED PADDLE SIZE DOES NOT INCLUDE MOLD FLASH.
- 4) LEAD COPLANARITY SHALL BE 0.10 MILLIMETERS MAX.
- 5) JEDEC REFERENCE IS MQ220.
- 6) DRAWING IS NOT TO SCALE

**NOTICE:** The information in this document is subject to change without notice. Please contact MPS for current specifications. Users should warrant and guarantee that third party Intellectual Property rights are not infringed upon when integrating MPS products into any application. MPS will not assume any legal responsibility for any said applications.