

REVISIONS

P	LTR	DESCRIPTION	DATE	DWN	APVD
	A1	REVISED PER ECO-11-005150	28MAR2011	RK	HMR
	BA	NEW PRODUCT INTRODUCTION	16JUN2022	LG	AP
	BA1	NEW PRODUCT INTRODUCTION	19OCT2022	DM	AP

FOR FURTHER INFORMATION SEE DATA SHEET FOR
CBT SERIES-CARBON COMPOSITION RESISTORS

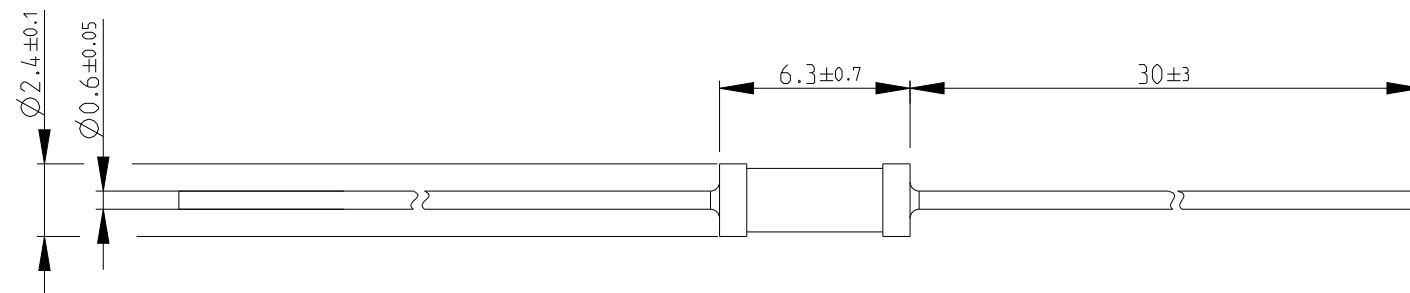

RoHS Compliant

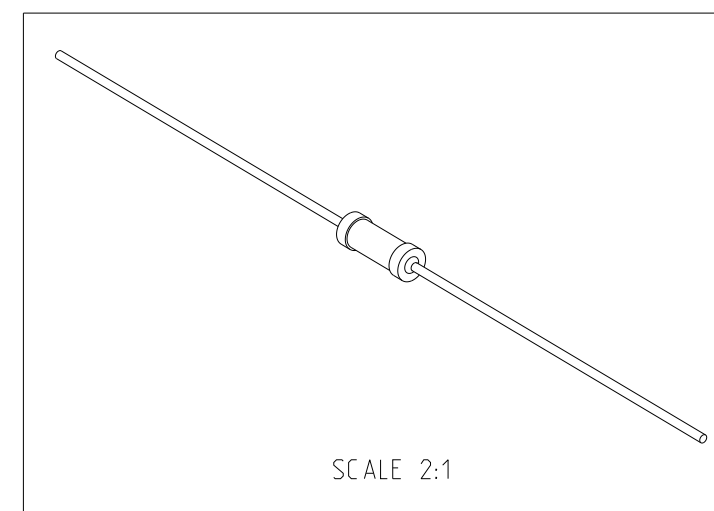

THIS DRAWING IS A CONTROLLED DOCUMENT.		DWN	16SEP2008			CARBON COMPOSITION RESISTORS TYPE CBT25 SERIES	
DIMENSIONS:		CHK	16SEP2008				
mm		APVD	16SEP2008				
		PRODUCT SPEC	NAME				
TOLERANCES UNLESS OTHERWISE SPECIFIED:		APPLICATION SPEC		RESTRICTED TO			
0 PLC	± 0.2	WEIGHT		SIZE	CAGE CODE	DRAWING NO	RESTRICTED TO
1 PLC	± 0.1	CUSTOMER DRAWING		A3	00779	C=1625875	-
2 PLC	\pm	SCALE		4:1		SHEET 1 OF 5	
3 PLC	\pm	REVISION		BA1			
4 PLC	\pm						
ANGLES	$\pm 5^\circ$						
MATERIAL	FINISH						

REVISIONS

P	LTR	DESCRIPTION	DATE	DWN	APVD
-		SEE SHEET 1	-	-	-

SCHEDULE

TCPN	CATALOGUE NUMBER	PART DESCRIPTION	PART STATUS
1625875-1	CBT25K100R	CBT 1/4 10% 100R	DISCONTINUED
1625875-2	CBT25K10R	CBT 1/4 10% 10R	PRODUCTION
1625875-3	CBT25J4R7	CBT 1/4 5% 4R7	DISCONTINUED
1625875-4	CBT25J100K	CBT 1/4 5% 100K	SUPERSEDED
1625875-5	CBT25J100R	CBT 1/4 5% 100R	PRODUCTION
1625875-6	CBT25J10K	CBT 1/4 5% 10K	PRODUCTION
1625875-7	CBT25J10R	CBT 1/4 5% 10R	PRODUCTION
1625875-8	CBT25J150K	CBT 1/4 5% 150K	SUPERSEDED
1625875-9	CBT25J150R	CBT 1/4 5% 150R	PRODUCTION
1-1625875-0	CBT25J15K	CBT 1/4 5% 15K	PRODUCTION
1-1625875-1	CBT25J15R	CBT 1/4 5% 15R	DISCONTINUED
1-1625875-2	CBT25J1K0	CBT 1/4 5% 1K0	PRODUCTION
1-1625875-3	CBT25J1K5	CBT 1/4 5% 1K5	PRODUCTION
1-1625875-4	CBT25J1M0	CBT 1/4 5% 1M0	SUPERSEDED
1-1625875-5	CBT25J1M5	CBT 1/4 5% 1M5	DISCONTINUED
1-1625875-6	CBT25J1R0	CBT 1/4 5% 1R0	PRODUCTION
1-1625875-7	CBT25J1R5	CBT 1/4 5% 1R5	PRODUCTION
1-1625875-8	CBT25J220K	CBT 1/4 5% 220K	SUPERSEDED
1-1625875-9	CBT25J220R	CBT 1/4 5% 220R	PRODUCTION
2-1625875-0	CBT25J22K	CBT 1/4 5% 22K	PRODUCTION

THIS DRAWING IS A CONTROLLED DOCUMENT.

DIMENSIONS:
mm

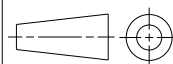

TOLERANCES UNLESS OTHERWISE SPECIFIED:

0 PLC	±0.2
1 PLC	±0.1
2 PLC	±
3 PLC	±
4 PLC	±
ANGLES	±5°

MATERIAL

FINISH

DWN SUBHASH.M 16SEP2008

CHK PRAKASH.S 16SEP2008

APVD STEPHEN.P 16SEP2008

PRODUCT SPEC

APPLICATION SPEC

WEIGHT

CUSTOMER DRAWING



TE Connectivity

NAME CARBON COMPOSITION RESISTORS
TYPE CBT25 SERIES

SIZE	CAGE CODE	DRAWING NO	RESTRICTED TO
------	-----------	------------	---------------

A3	00779	©=1625875	-
----	-------	-----------	---

SCALE 4:1	SHEET 2 OF 5	REV BA1
-----------	--------------	---------

REVISIONS

P	LTR	DESCRIPTION	DATE	DWN	APVD
-		SEE SHEET 1	-	-	-

SCHEDULE

TCPN	CATALOGUE NUMBER	PART DESCRIPTION	PART STATUS
2-1625875-1	CBT25J22R	CBT 1/4 5% 22R	PRODUCTION
2-1625875-2	CBT25J2K2	CBT 1/4 5% 2K2	PRODUCTION
2-1625875-3	CBT25J2M2	CBT 1/4 5% 2M2	DISCONTINUED
2-1625875-4	CBT25J2R2	CBT 1/4 5% 2R2	PRODUCTION
2-1625875-5	CBT25J330K	CBT 1/4 5% 330K	SUPERSEDED
2-1625875-6	CBT25J330R	CBT 1/4 5% 330R	PRODUCTION
2-1625875-7	CBT25J33K	CBT 1/4 5% 33K	PRODUCTION
2-1625875-8	CBT25J33R	CBT 1/4 5% 33R	PRODUCTION
2-1625875-9	CBT25J3K3	CBT 1/4 5% 3K3	PRODUCTION
3-1625875-0	CBT25J3M3	CBT 1/4 5% 3M3	SUPERSEDED
3-1625875-1	CBT25J3R3	CBT 1/4 5% 3R3	PRODUCTION
3-1625875-2	CBT25J470K	CBT 1/4 5% 470K	SUPERSEDED
3-1625875-3	CBT25J470R	CBT 1/4 5% 470R	PRODUCTION
3-1625875-4	CBT25J47K	CBT 1/4 5% 47K	PRODUCTION
3-1625875-5	CBT25J47R	CBT 1/4 5% 47R	PRODUCTION
3-1625875-6	CBT25J4K7	CBT 1/4 5% 4K7	PRODUCTION
3-1625875-7	CBT25J4M7	CBT 1/4 5% 4M7	SUPERSEDED
3-1625875-8	CBT25J680K	CBT 1/4 5% 680K	SUPERSEDED
3-1625875-9	CBT25J680R	CBT 1/4 5% 680R	PRODUCTION
4-1625875-0	CBT25J68K	CBT 1/4 5% 68K	PRODUCTION

THIS DRAWING IS A CONTROLLED DOCUMENT.

DIMENSIONS:
mm

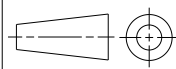

MATERIAL

TOLERANCES UNLESS OTHERWISE SPECIFIED:

- 0 PLC ±0.2
- 1 PLC ±0.1
- 2 PLC ±
- 3 PLC ±
- 4 PLC ±
- ANGLES ±5°
- FINISH

DWN SUBHASH.M 16SEP2008

CHK PRAKASH.S 16SEP2008

APVD STEPHEN.P 16SEP2008

PRODUCT SPEC

APPLICATION SPEC

WEIGHT

CUSTOMER DRAWING

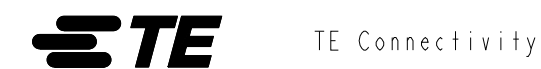

NAME CARBON COMPOSITION RESISTORS
TYPE CBT25 SERIES

SIZE	CAGE CODE	DRAWING NO	RESTRICTED TO
------	-----------	------------	---------------

A3	00779	©-1625875	-
----	-------	-----------	---

SCALE 4:1	SHEET 3 OF 5	REV BA1
-----------	--------------	---------

REVISIONS

P	LTR	DESCRIPTION	DATE	DWN	APVD
-		SEE SHEET 1	-	-	-

SCHEDULE

TCPN	CATALOGUE NUMBER	PART DESCRIPTION	PART STATUS
4-1625875-1	CBT25J68R	CBT 1/4 5% 68R	PRODUCTION
4-1625875-2	CBT25J6K8	CBT 1/4 5% 6K8	PRODUCTION
4-1625875-3	CBT25J6R8	CBT 1/4 5% 6R8	PRODUCTION
4-1625875-4	CBT25K100K	CBT 1/4 10% 100K	PRODUCTION
4-1625875-5	CBT25J120K	CBT 1/4 5% 120K	DISCONTINUED
4-1625875-6	CBT25J100RT	CBT 1/4 5% 100R TAPED & REELED	DISCONTINUED
4-1625875-7	CBT25K220K	CBT 1/4 10% 220K	PRODUCTION
4-1625875-8	CBT25K330K	CBT 1/4 10% 330K	PRODUCTION
4-1625875-9	CBT25K470K	CBT 1/4 10% 470K	PRODUCTION
5-1625875-0	CBT25K680K	CBT 1/4 10% 680K	PRODUCTION
5-1625875-1	CBT25K150K	CBT 1/4 10% 150K	PRODUCTION
5-1625875-2	CBT25K4M7	CBT 1/4 10% 4M7	PRODUCTION
5-1625875-3	CBT25K1M0	CBT 1/4 10% 1M0	PRODUCTION
5-1625875-4	CBT25K3M3	CBT 1/4 10% 3M3	PRODUCTION
5-1625875-5	CBT25K110K	CBT 1/4 10% 110K	PRODUCTION
5-1625875-6	CBT25K1R0	CBT 1/4 10% 1R0	PRODUCTION
5-1625875-7	CBT25K1R5	CBT 1/4 10% 1R5	PRODUCTION
5-1625875-8	CBT25K2R2	CBT 1/4 10% 2R2	PRODUCTION
5-1625875-9	CBT25K3R3	CBT 1/4 10% 3R3	PRODUCTION
6-1625875-0	CBT25K6R8	CBT 1/4 10% 6R8	PRODUCTION

THIS DRAWING IS A CONTROLLED DOCUMENT.

DIMENSIONS:
mm

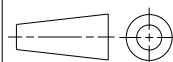

TOLERANCES UNLESS OTHERWISE SPECIFIED:

- 0 PLC ±0.2
- 1 PLC ±0.1
- 2 PLC ±
- 3 PLC ±
- 4 PLC ±
- ANGLES ±5°

MATERIAL

FINISH

DWN SUBHASH.M 16SEP2008

CHK PRAKASH.S 16SEP2008

APVD STEPHEN.P 16SEP2008

PRODUCT SPEC

APPLICATION SPEC

WEIGHT

CUSTOMER DRAWING



TE Connectivity

NAME CARBON COMPOSITION RESISTORS
TYPE CBT25 SERIES

SIZE CAGE CODE DRAWING NO RESTRICTED TO

A3 00779 C-1625875

SCALE 4:1 SHEET 4 OF 5 REV BA1

REVISIONS

P	LTR	DESCRIPTION	DATE	DWN	APVD
	-	SEE SHEET 1	-	-	-

SCHEDULE

TCPN	CATALOGUE NUMBER	PART DESCRIPTION	PART STATUS
6-1625875-1	CBT25K22R	CBT 1/4 10% 22R	PRODUCTION
6-1625875-2	CBT25K33R	CBT 1/4 10% 33R	PRODUCTION
6-1625875-3	CBT25K47R	CBT 1/4 10% 47R	PRODUCTION
6-1625875-4	CBT25K68R	CBT 1/4 10% 68R	PRODUCTION
6-1625875-5	CBT25K100R	CBT 1/4 10% 100R	PRODUCTION
6-1625875-6	CBT25K150R	CBT 1/4 10% 150R	PRODUCTION
6-1625875-7	CBT25K220R	CBT 1/4 10% 220R	PRODUCTION
6-1625875-8	CBT25K330R	CBT 1/4 10% 330R	PRODUCTION
6-1625875-9	CBT25K470R	CBT 1/4 10% 470R	PRODUCTION
7-1625875-0	CBT25K680R	CBT 1/4 10% 680R	PRODUCTION
7-1625875-1	CBT25K1K0	CBT 1/4 10% 1K0	PRODUCTION
7-1625875-2	CBT25K1K5	CBT 1/4 10% 1K5	PRODUCTION
7-1625875-3	CBT25K2K2	CBT 1/4 10% 2K2	PRODUCTION
7-1625875-4	CBT25K3K3	CBT 1/4 10% 3K3	PRODUCTION
7-1625875-5	CBT25K4K7	CBT 1/4 10% 4K7	PRODUCTION
7-1625875-6	CBT25K6K8	CBT 1/4 10% 6K8	PRODUCTION
7-1625875-7	CBT25K10K	CBT 1/4 10% 10K	PRODUCTION
7-1625875-8	CBT25K15K	CBT 1/4 10% 15K	PRODUCTION
7-1625875-9	CBT25K22K	CBT 1/4 10% 22K	PRODUCTION
8-1625875-0	CBT25K33K	CBT 1/4 10% 33K	PRODUCTION
8-1625875-1	CBT25K47K	CBT 1/4 10% 47K	PRODUCTION
8-1625875-2	CBT25K68K	CBT 1/4 10% 68K	PRODUCTION

THIS DRAWING IS A CONTROLLED DOCUMENT.

DIMENSIONS:
mm

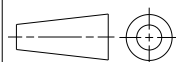

MATERIAL

TOLERANCES UNLESS OTHERWISE SPECIFIED:

- 0 PLC ±0.2
- 1 PLC ±0.1
- 2 PLC ±
- 3 PLC ±
- 4 PLC ±
- ANGLES ±5°

FINISH

DWN SUBHASH.M 16SEP2008

CHK PRAKASH.S 16SEP2008

APVD STEPHEN.P 16SEP2008

PRODUCT SPEC

APPLICATION SPEC

WEIGHT

CUSTOMER DRAWING



TE Connectivity

NAME CARBON COMPOSITION RESISTORS
TYPE CBT25 SERIES

SIZE CAGE CODE DRAWING NO RESTRICTED TO

A3 00779 C-1625875

SCALE 4:1 SHEET 5 OF 5 REV BA1