



Main

Range of Product	Telemecanique Photoelectric sensors XU
Series name	General purpose single mode
Electronic sensor type	Photo-electric sensor
Sensor name	XUX
Sensor design	Compact 92 x 71
Detection system	Polarised reflex
Material	Plastic
Type of output signal	Discrete
Supply circuit type	DC
Wiring Technique	3-wire
Discrete output type	PNP
Discrete output function	1 NO
Electrical connection	1 male connector M12, 4 pins
Product Specific Application	-
Emission	Red polarised reflex
[Sn] nominal sensing distance	36.09 ft (11 m) polarised reflex need reflector XUZC50

Complementary

Enclosure Material	PBT
Lens material	PMMA
Maximum sensing distance	49.21 ft (15 m) polarised reflex
Output Type	Solid state
Status LED	1 LED yellow)output state 1 LED green)supply
[Us] rated supply voltage	12...24 V DC
Switching capacity in mA	<= 100 mA overload and short-circuit protection)
Switching frequency	<= 250 Hz
Maximum voltage drop	<1.5 V closed state)
Current consumption	<= 35 mA no-load
Maximum delay first up	15 ms
Maximum delay response	2 ms
Maximum delay recovery	2 ms
Setting-up	Sensitivity adjustment
Depth	3.03 in (77 mm)
Height	3.62 in (92 mm)
Width	1.22 in (31 mm)
Net Weight	0.44 lb(US) (0.2 kg)

Environment

Product Certifications	CE UL CSA
Ambient air temperature for operation	-13...131 °F (-25...55 °C)
Ambient Air Temperature for Storage	-40...158 °F (-40...70 °C)
Vibration resistance	7 gn +/- 1.5 mm 10...55 Hz) IEC 60068-2-6
Shock resistance	30 gn 11 ms) IEC 60068-2-27
IP degree of protection	IP67 double insulation IEC 60529 IP65 double insulation IEC 60529





Ordering and shipping details

Category	22481-SENSORS, PHOTOELECTRIC
Discount Schedule	DS2
GTIN	3389110171488
Nbr. of units in pkg.	1
Package weight(Lbs)	6.56 oz (186.0 g)
Returnability	No
Country of origin	FR

Packing Units

Unit Type of Package 1	PCE
Package 1 Height	1.65 in (4.2 cm)
Package 1 width	3.78 in (9.6 cm)
Package 1 Length	5.20 in (13.2 cm)
Unit Type of Package 2	S01
Number of Units in Package 2	11
Package 2 Weight	4.93 lb(US) (2.236 kg)
Package 2 Height	5.91 in (15 cm)
Package 2 width	5.91 in (15 cm)
Package 2 Length	15.75 in (40 cm)

Offer Sustainability

Sustainable offer status	Green Premium product
California proposition 65	WARNING: This product can expose you to chemicals including: Diisononyl phthalate (DINP), which is known to the State of California to cause cancer, and Di-isodecyl phthalate (DIDP), which is known to the State of California to cause birth defects or other reproductive harm. For more information go to www.P65Warnings.ca.gov
REACH Regulation	 REACH Declaration
EU RoHS Directive	Pro-active compliance (Product out of EU RoHS legal scope)  EU RoHS Declaration
Mercury free	Yes
RoHS exemption information	 Yes
Environmental Disclosure	 Product Environmental Profile
Circularity Profile	 End Of Life Information

Contractual warranty

Warranty	18 months
----------	-----------

Dimensions

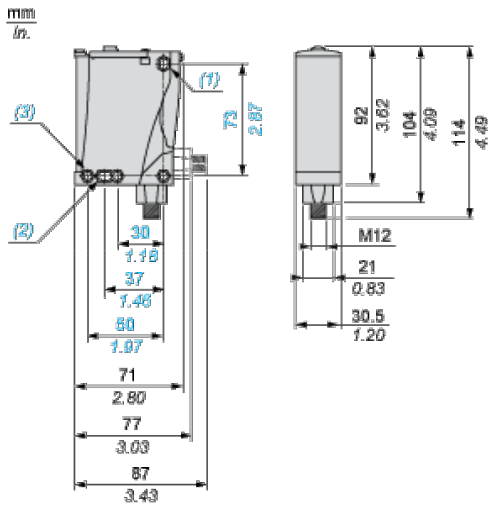

- (1) Elongated hole $\text{\O} 5.5 \times 7$
- (2) Elongated hole $\text{\O} 5.5 \times 9$
- (3) $\text{\O} 5.5$ hole

Mounting and Clearance

Possible Orientation of Elbowed Connector (Rear View)

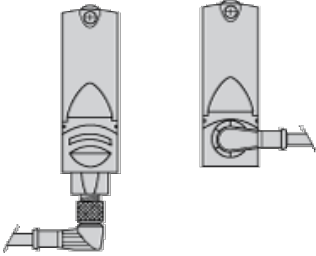

Wiring Schemes

M12 Connector

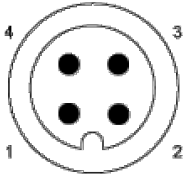

PNP/NPN DC

M12		Terminals		
1	●	1	⊘	+
3	●	2	⊘	-
4	●	3	⊘	Output

Detection Curves

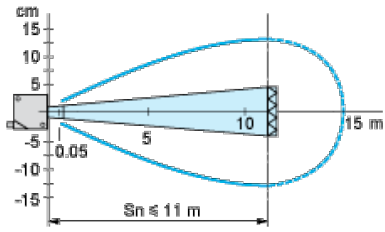

With reflector XUZC50