

## Thunderbolt IGBT®

The Thunderbolt IGBT® is a new generation of high voltage power IGBTs. Using Non-Punch Through Technology, the Thunderbolt IGBT® offers superior ruggedness and ultrafast switching speed.

- Low Forward Voltage Drop
- High Freq. Switching to 150KHz
- Low Tail Current
- Ultra Low Leakage Current
- RBSOA and SCSOA Rated

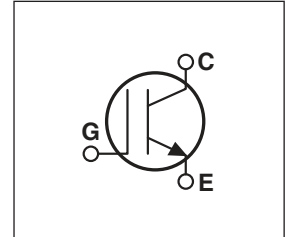
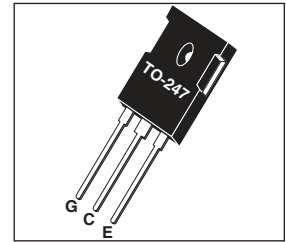

### MAXIMUM RATINGS

All Ratings:  $T_C = 25^\circ\text{C}$  unless otherwise specified.

Symbol	Parameter	APT15GT60BR(G)	UNIT
$V_{CES}$	Collector-Emitter Voltage	600	Volts
$V_{GE}$	Gate-Emitter Voltage	$\pm 30$	
$I_{C1}$	Continuous Collector Current @ $T_C = 25^\circ\text{C}$	42	Amps
$I_{C2}$	Continuous Collector Current @ $T_C = 110^\circ\text{C}$	20	
$I_{CM}$	Pulsed Collector Current <sup>①</sup>	45	
SSOA	Switching Safe Operating Area @ $T_J = 150^\circ\text{C}$	45A @ 600V	
$P_D$	Total Power Dissipation	184	Watts
$T_J, T_{STG}$	Operating and Storage Junction Temperature Range	-55 to 150	$^\circ\text{C}$
$T_L$	Max. Lead Temp. for Soldering: 0.063" from Case for 10 Sec.	300	

### STATIC ELECTRICAL CHARACTERISTICS

Symbol	Characteristic / Test Conditions	MIN	TYP	MAX	Units
$V_{(BR)CES}$	Collector-Emitter Breakdown Voltage ( $V_{GE} = 0\text{V}, I_C = 250\mu\text{A}$ )	600			Volts
$V_{GE(TH)}$	Gate Threshold Voltage ( $V_{CE} = V_{GE}, I_C = 700\mu\text{A}, T_J = 25^\circ\text{C}$ )	3	4	5	
$V_{CE(ON)}$	Collector-Emitter On Voltage ( $V_{GE} = 15\text{V}, I_C = 15\text{A}, T_J = 25^\circ\text{C}$ )	1.6	2.0	2.5	
	Collector-Emitter On Voltage ( $V_{GE} = 15\text{V}, I_C = 15\text{A}, T_J = 125^\circ\text{C}$ )		2.8		
$I_{CES}$	Collector Cut-off Current ( $V_{CE} = 600\text{V}, V_{GE} = 0\text{V}, T_J = 25^\circ\text{C}$ ) <sup>②</sup>			25	$\mu\text{A}$
	Collector Cut-off Current ( $V_{CE} = 600\text{V}, V_{GE} = 0\text{V}, T_J = 125^\circ\text{C}$ ) <sup>②</sup>			1500	
$I_{GES}$	Gate-Emitter Leakage Current ( $V_{GE} = \pm 20\text{V}$ )			$\pm 100$	nA



**CAUTION:** These Devices are Sensitive to Electrostatic Discharge. Proper Handling Procedures Should Be Followed.

## DYNAMIC CHARACTERISTICS

APT15GT60BR(G)

Symbol	Characteristic	Test Conditions	MIN	TYP	MAX	UNIT	
$C_{ies}$	Input Capacitance	<b>Capacitance</b> $V_{GE} = 0V, V_{CE} = 25V$ $f = 1 \text{ MHz}$		830		pF	
$C_{oes}$	Output Capacitance			120			
$C_{res}$	Reverse Transfer Capacitance			50			
$V_{GEP}$	Gate-to-Emitter Plateau Voltage	Gate Charge		7.5		V	
$Q_g$	Total Gate Charge <sup>③</sup>	$V_{GE} = 15V$		75		nC	
$Q_{ge}$	Gate-Emitter Charge	$V_{CE} = 300V$		6			
$Q_{gc}$	Gate-Collector ("Miller") Charge	$I_C = 15A$		34			
SSOA	Switching Safe Operating Area	$T_J = 150^\circ\text{C}, R_G = 10\Omega, V_{GE} = 15V, L = 100\mu\text{H}, V_{CE} = 600V$	45			A	
$t_{d(on)}$	Turn-on Delay Time	<b>Inductive Switching (25°C)</b> $V_{CC} = 400V$ $V_{GE} = 15V$ $I_C = 15A$ $R_G = 10\Omega$ $T_J = +25^\circ\text{C}$		6		ns	
$t_r$	Current Rise Time			8			
$t_{d(off)}$	Turn-off Delay Time			105			
$t_f$	Current Fall Time			55			
$E_{on1}$	Turn-on Switching Energy <sup>④</sup>				150		μJ
$E_{on2}$	Turn-on Switching Energy (Diode) <sup>⑤</sup>			195			
$E_{off}$	Turn-off Switching Energy <sup>⑥</sup>			215			
$t_{d(on)}$	Turn-on Delay Time	<b>Inductive Switching (125°C)</b> $V_{CC} = 400V$ $V_{GE} = 15V$ $I_C = 15A$ $R_G = 10\Omega$ $T_J = +125^\circ\text{C}$		6		ns	
$t_r$	Current Rise Time			8			
$t_{d(off)}$	Turn-off Delay Time			125			
$t_f$	Current Fall Time			100			
$E_{on1}$	Turn-on Switching Energy <sup>④</sup>				150		μJ
$E_{on2}$	Turn-on Switching Energy (Diode) <sup>⑤</sup>				325		
$E_{off}$	Turn-off Switching Energy <sup>⑥</sup>				325		

## THERMAL AND MECHANICAL CHARACTERISTICS

Symbol	Characteristic	MIN	TYP	MAX	UNIT
$R_{\theta JC}$	Junction to Case (IGBT)			.68	°C/W
$R_{\theta JC}$	Junction to Case (DIODE)			N/A	
$W_T$	Package Weight		5.9		gm

- ① Repetitive Rating: Pulse width limited by maximum junction temperature.
- ② For Combi devices,  $I_{ces}$  includes both IGBT and FRED leakages
- ③ See MIL-STD-750 Method 3471.
- ④  $E_{on1}$  is the clamped inductive turn-on energy of the IGBT only, without the effect of a commutating diode reverse recovery current adding to the IGBT turn-on loss. Tested in inductive switching test circuit shown in figure 21, but with a Silicon Carbide diode.
- ⑤  $E_{on2}$  is the clamped inductive turn-on energy that includes a commutating diode reverse recovery current in the IGBT turn-on switching loss. (See Figures 21, 22.)
- ⑥  $E_{off}$  is the clamped inductive turn-off energy measured in accordance with JEDEC standard JESD24-1. (See Figures 21, 23.)

APT Reserves the right to change, without notice, the specifications and information contained herein.

# TYPICAL PERFORMANCE CURVES

APT15GT60BR(G)

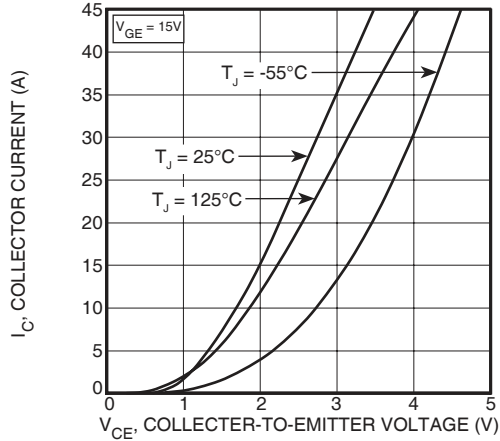

FIGURE 1, Output Characteristics ( $T_J = 25^\circ C$ )

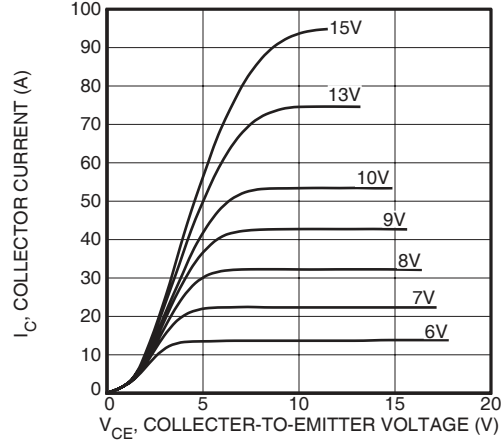

FIGURE 2, Output Characteristics ( $T_J = 125^\circ C$ )

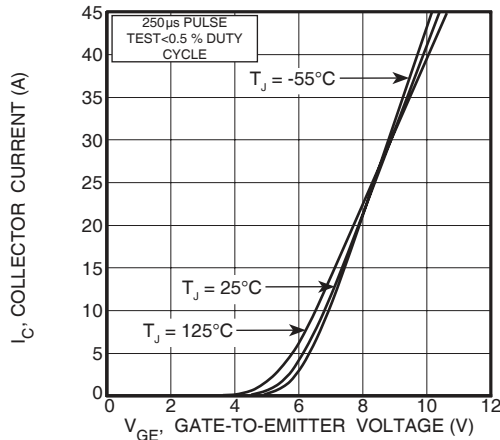

FIGURE 3, Transfer Characteristics

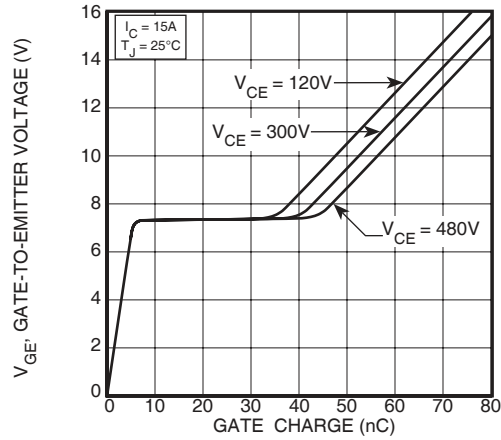

FIGURE 4, Gate Charge

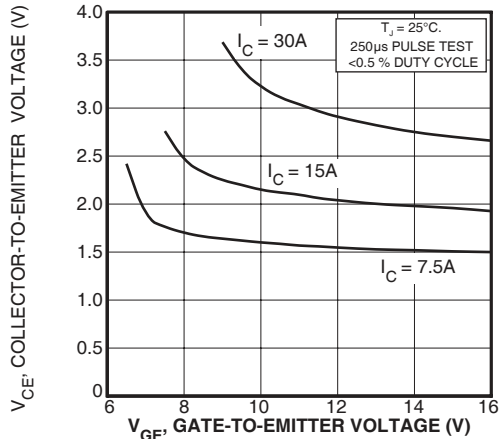

FIGURE 5, On State Voltage vs Gate-to-Emitter Voltage

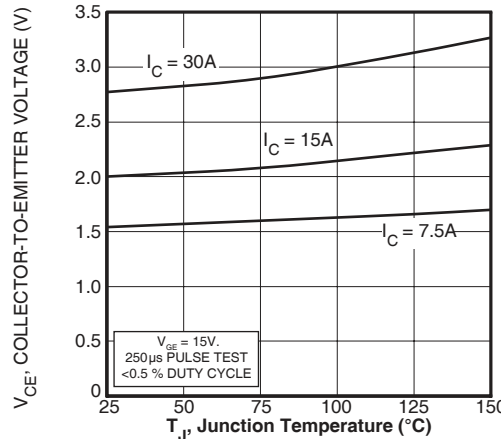

FIGURE 6, On State Voltage vs Junction Temperature

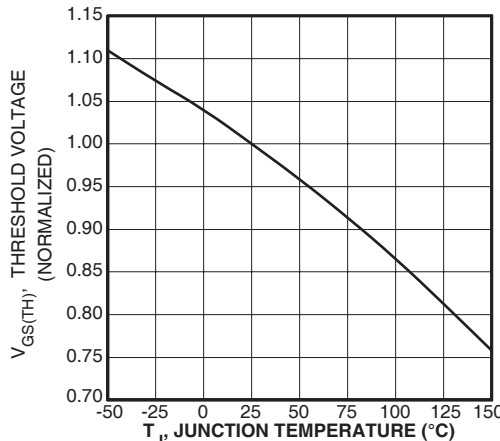

FIGURE 7, Threshold Voltage vs. Junction Temperature

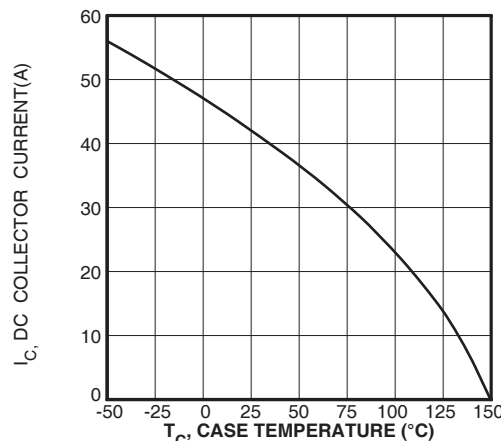

FIGURE 8, DC Collector Current vs Case Temperature

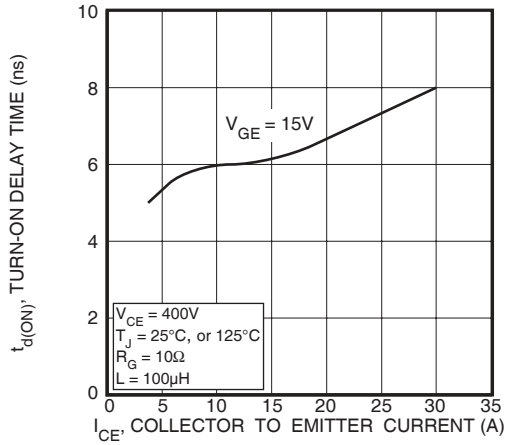

FIGURE 9, Turn-On Delay Time vs Collector Current

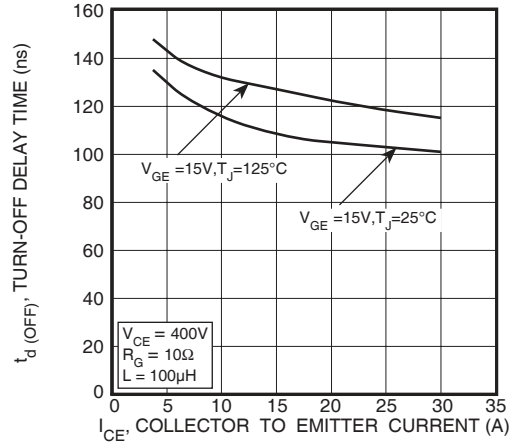

FIGURE 10, Turn-Off Delay Time vs Collector Current

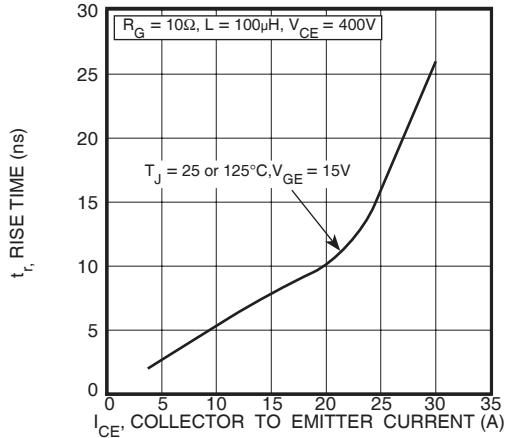

FIGURE 11, Current Rise Time vs Collector Current

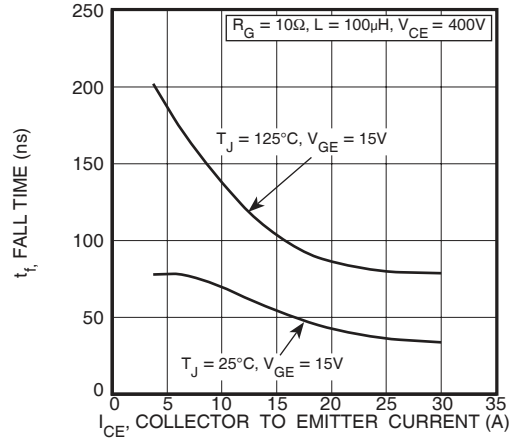

FIGURE 12, Current Fall Time vs Collector Current

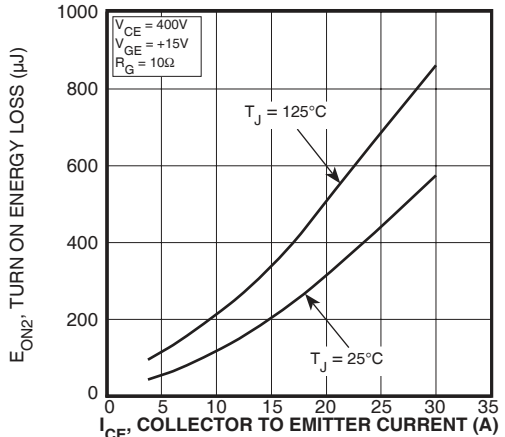

FIGURE 13, Turn-On Energy Loss vs Collector Current

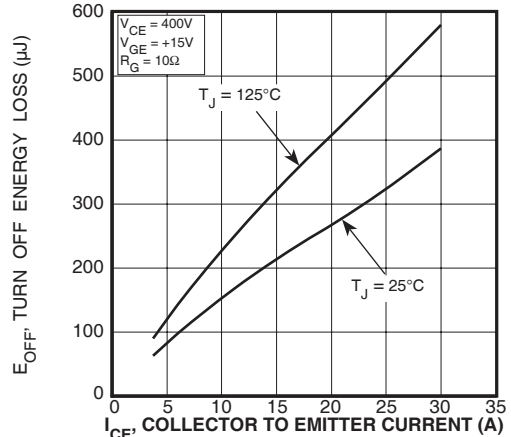

FIGURE 14, Turn Off Energy Loss vs Collector Current

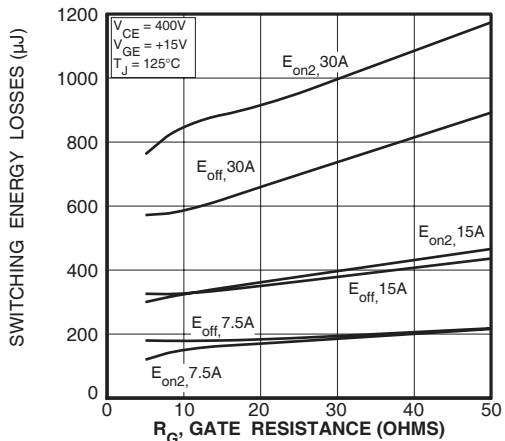

FIGURE 15, Switching Energy Losses vs. Gate Resistance

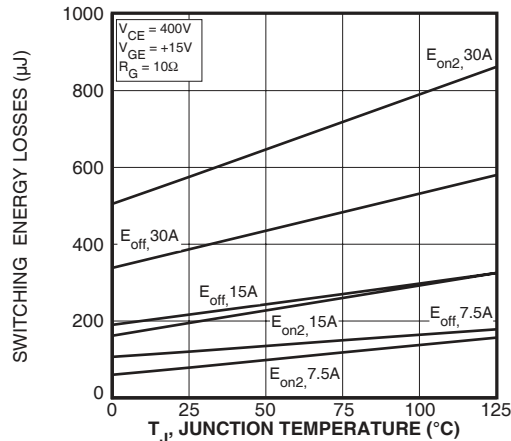

FIGURE 16, Switching Energy Losses vs Junction Temperature

**TYPICAL PERFORMANCE CURVES**

**APT15GT60BR(G)**

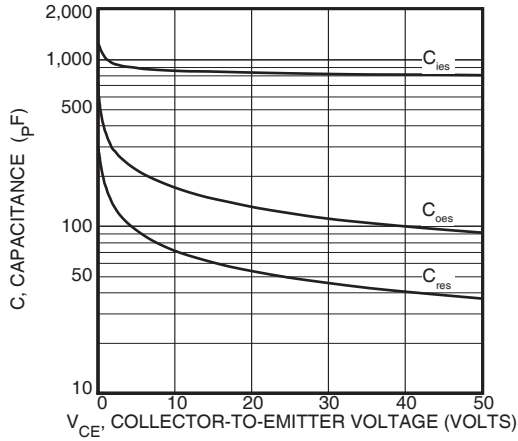

Figure 17, Capacitance vs Collector-To-Emitter Voltage

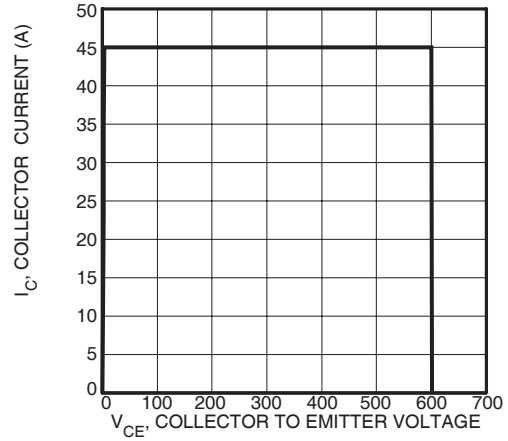

Figure 18, Minimum Switching Safe Operating Area

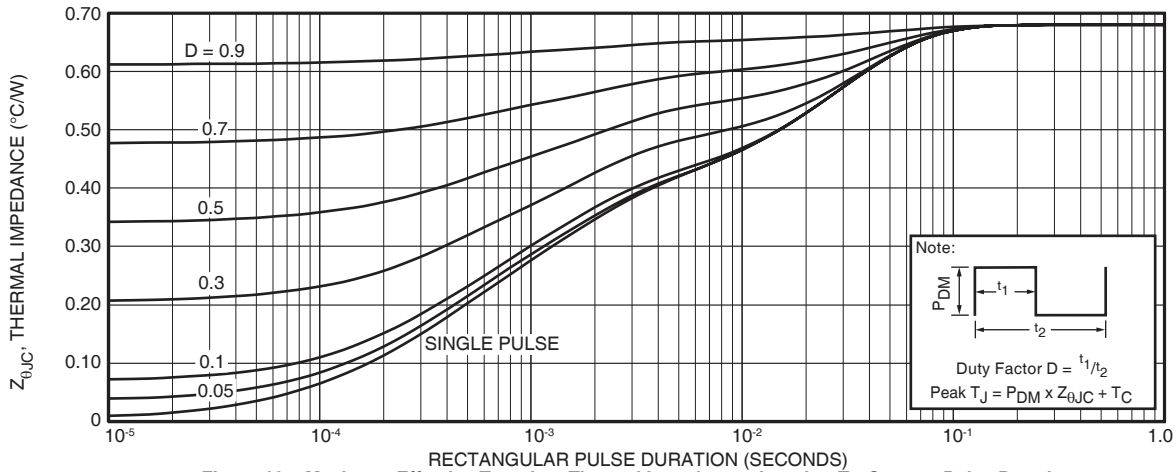

Figure 19a, Maximum Effective Transient Thermal Impedance, Junction-To-Case vs Pulse Duration

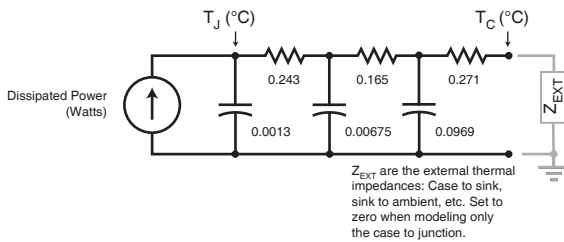

FIGURE 19b, TRANSIENT THERMAL IMPEDANCE MODEL

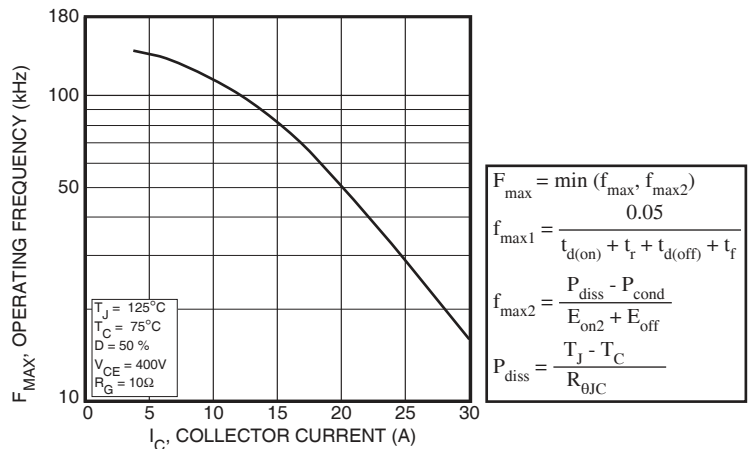

Figure 20, Operating Frequency vs Collector Current

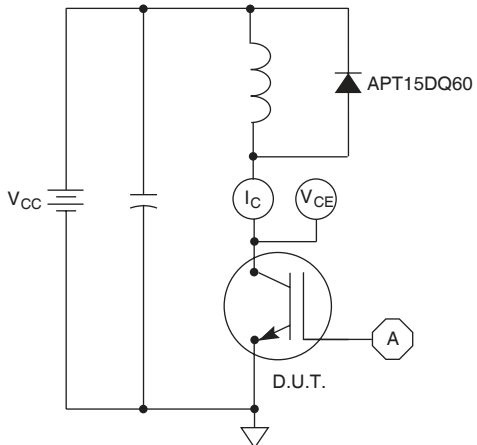

Figure 21, Inductive Switching Test Circuit

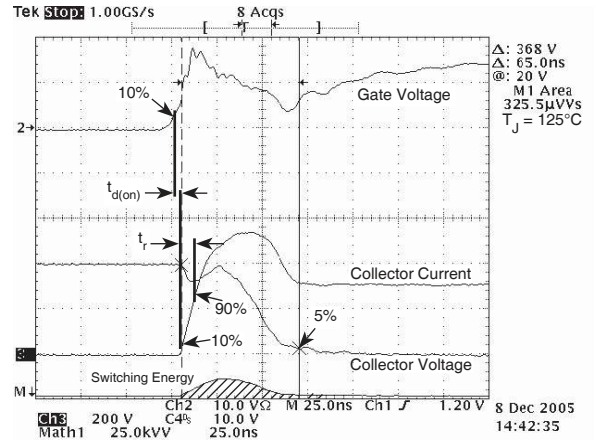

Figure 22, Turn-on Switching Waveforms and Definitions

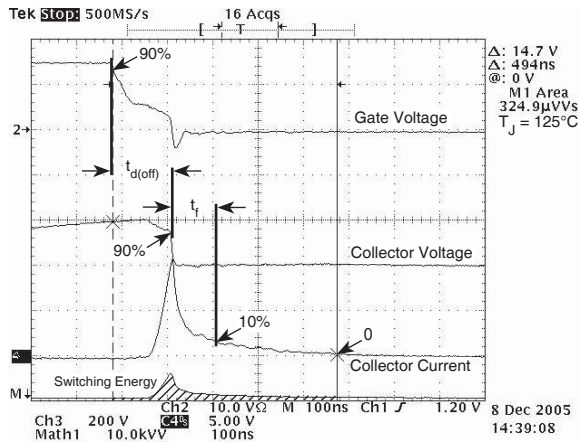
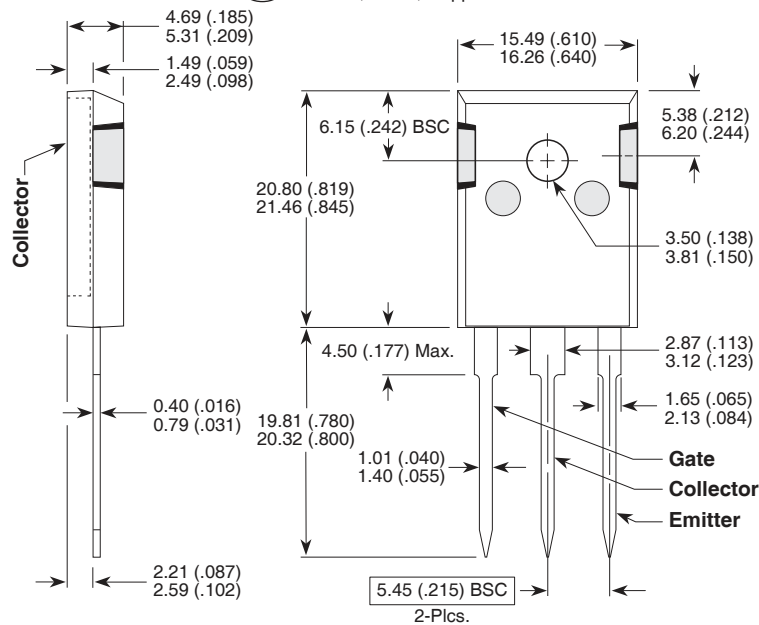

Figure 23, Turn-off Switching Waveforms and Definitions

TO-247 Package Outline

(e1) SAC: Tin, Silver, Copper



Dimensions in Millimeters and (Inches)