

2SA1908

Silicon PNP Epitaxial Planar Transistor (Complement to type 2SC5100)

Application : Audio and General Purpose

■Absolute maximum ratings (Ta=25°C)

| Symbol | Ratings | Unit |
|------------------|--------------------------|------|
| V _{CB0} | -120 | V |
| V _{CE0} | -120 | V |
| V _{EBO} | -6 | V |
| I _c | -8 | A |
| I _B | -3 | A |
| P _c | 75(T _c =25°C) | W |
| T _j | 150 | °C |
| T _{stg} | -55 to +150 | °C |

■Electrical Characteristics (Ta=25°C)

| Symbol | Conditions | Ratings | Unit |
|----------------------|---|---------|------|
| I _{CB0} | V _{CB} =-120V | -10max | μA |
| I _{EBO} | V _{EB} =-6V | -10max | μA |
| V _{(BR)CEO} | I _c =-50mA | -120min | V |
| h _{FE} | V _{CE} =-4V, I _c =-3A | 50min* | |
| V _{CE(sat)} | I _c =-3A, I _B =-0.3A | -0.5max | V |
| f _T | V _{CE} =-12V, I _E =0.5A | 20typ | MHz |
| COB | V _{CB} =-10V, f=1MHz | 300typ | pF |

*h_{FE} Rank O(50 to 100), P(70 to 140), Y(90 to 180)

■Typical Switching Characteristics (Common Emitter)

| V _{CC} (V) | R _L (Ω) | I _c (A) | V _{BB1} (V) | V _{BB2} (V) | I _{B1} (A) | I _{B2} (A) | t _{on} (μs) | t _{stg} (μs) | t _f (μs) |
|---------------------|--------------------|--------------------|----------------------|----------------------|---------------------|---------------------|----------------------|-----------------------|---------------------|
| -40 | 10 | -4 | -10 | 5 | -0.4 | 0.4 | 0.14typ | 1.40typ | 0.21typ |

External Dimensions FM100(TO3PF)

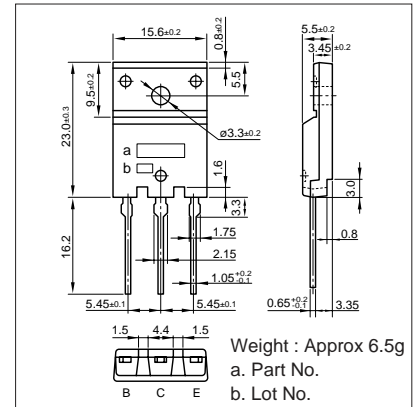

I_c-V_{CE} Characteristics (Typical)

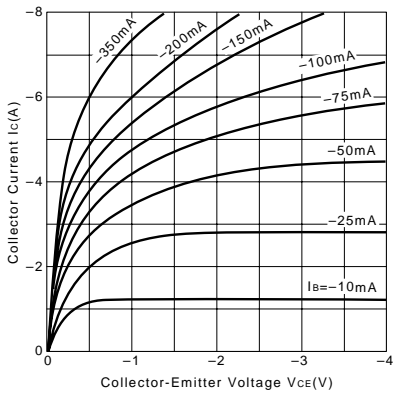

V_{CE(sat)}-I_B Characteristics (Typical)

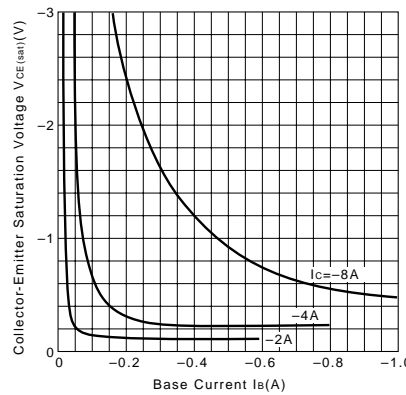

I_c-V_{BE} Temperature Characteristics (Typical)

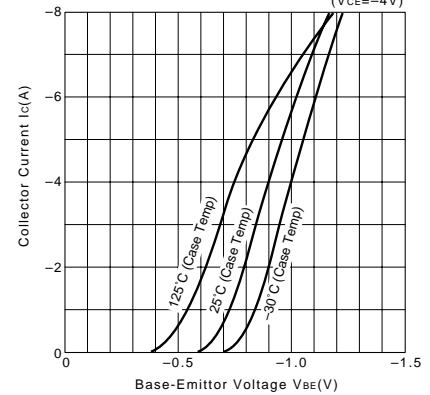

h_{FE}-I_c Characteristics (Typical)

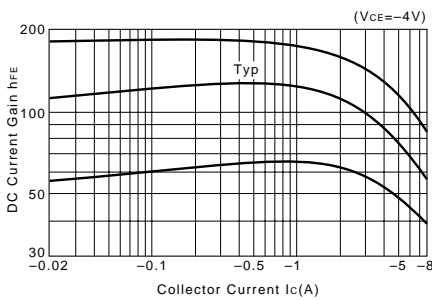

h_{FE}-I_c Temperature Characteristics (Typical)

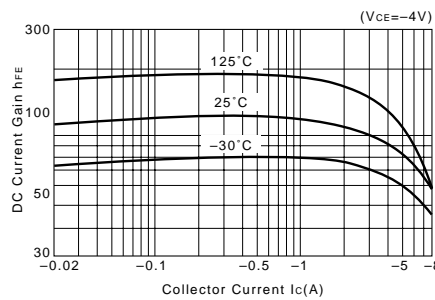

θ_{j-a}-t Characteristics

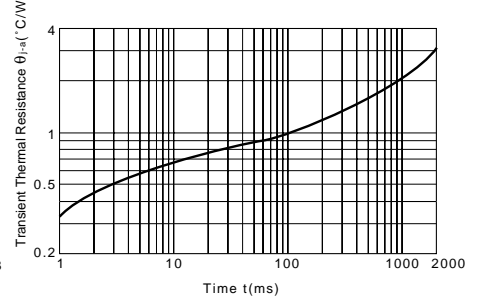

f_T-I_E Characteristics (Typical)

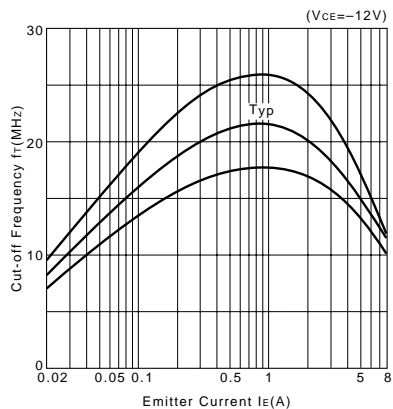

Safe Operating Area (Single Pulse)

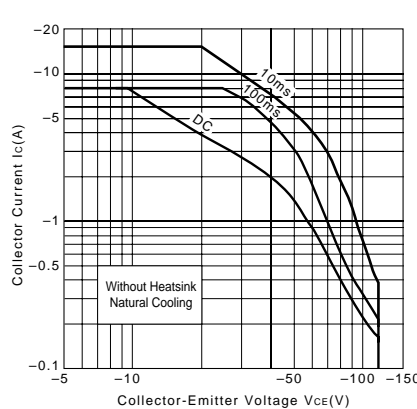

P_c-T_a Derating

