

KDV Series

Metal Film Low-Resistance Chip Resistor



FEATURES

- Low Resistance / TCR / Inductance
- Excellent long-term stability
- High precision current sensing
- High power capability
- Halogen free and lead free
- RoHs compliant

APPLICATIONS

- Consumer electronics
- Computer
- Telecom
- Measuring instrument
- Industrial / Power supply
- Battery management system

SERIES SPECIFICATIONS

Series	Size	Power @70°C	Max. Rated Current	Max. Overload Current	TCR (ppm/°C)	Resistance Range
KDV02	0201	1/10W	1.41A	3.16A		
KDV04	0402	1/8W	1.58A	3.54A	±100	50mΩ ~ 100mΩ
KDV06	0603	1/5W	2.00A	4.47A	±50	100mΩ ~ 1000mΩ
KDV08	0805	1/4W	2.24A	5.00A		
KDV12	1206	1/2W	3.16A	7.07A		

CHARACTERISTICS

Operating Temp. Range -55°C ~+155°C

Power rating and current rating Based on continuous full-load at ambient temperature of 70°C

TCR Test to -55°C is available on request

Rated Current Resistance Range: ≤1Ω. DC continuous working current or a AC (rms) continuous working current at commercial-line frequency and wave form corresponding to the power rating, as determined formula
 Rated current = $\sqrt{\text{Rated power}/\text{Resistance}}$

Storage Storage time at environmental temp. 25°C ±5° & humidity 60 ±20% is valid for one year from the date of delivery

Derating

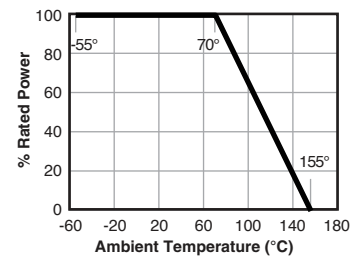

DIMENSIONS

(mm)

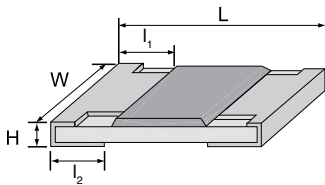

Size	L	W	H	l1	l2	A	B	C
KDV02	0.60 ±.03	0.30 ±.03	0.26 ±.05	0.15 ±.05	0.15 ±.05	0.25	0.85	0.35
KDV04	1.00 ±.10	0.50 ±.05	0.35 ±.05	0.20 ±.10	0.25 ±.10	0.50	1.60	0.70
KDV06	1.60 ±.10	0.80 ±.10	0.45 ±.10	0.25 ±.15	0.30 ±.15	0.80	2.40	1.00
KDV08	2.00 ±.10	1.25 ±.10	0.55 ±.10	0.35 ±.20	0.40 ±.20	1.30	2.90	1.45
KDV12	3.10 ±.10	1.60 ±.10	0.55 ±.10	0.40 ±.20	0.45 ±.20	2.20	4.20	1.80

Land pattern

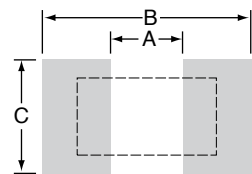

KDV Series

Metal Film Low-Resistance Chip Resistor

PERFORMANCE DATA

Test Method	Method	Procedure	Requirements
Temp. Coefficient of Resistance (T.C.R.)	JIS C 5201-1, clause 4.8	TCR +125°C, 25°C is the reference temperature	Refer to Standard Electrical Specifications
Short Time Overload	JIS C 5201-1, clause 4.13	Standard power: 6.25 times rated power whichever is less for 5 seconds High power (2X/4X): 5 times rated power whichever is less for 5 seconds.	±(1.0%+0.001Ω)
Insulation Resistance	JIS C 5201-1, clause 4.6	100V for 1 minute.	≥10GΩ
Solderability	JIS C 5201-1, clause 4.17	245 ±5°C for 3 ±0.5secs.	>95% Coverage, No visible damage
Resistance to Soldering Heat	JIS-C5201-1, clause 4.18	260 ±5°C for 10 seconds.	±(1.0%+0.001Ω), No visible damage
Leaching	JIS-C5201-1, clause 4.18	260 ±5°C for 30 seconds.	>95% Coverage, No visible damage
Temperature Cycling	JIS C 5201-1, clause 4.19	-55°C to +155°C, 300 cycles	±(1.0%+0.001Ω), No visible damage
High Temperature Exposure	JIS-C5201-1 4.25	155 ±5°C for 1000 +48/-0 hours.	±(1.0%+0.001Ω)
Resistance to Solvent	JIS C 5201-1, clause 4.29	The tested resistor be immersed into isopropyl alcohol of 20~25°C for 60 secs. Then the resistor is left in the room for 48 hrs.	±(1.0%+0.001Ω), No visible damage
Load Life in Humidity	JIS C 5201-1 clause 4.24	40±2°C, 90~95% R.H. , Rated power or Max. working current whichever is less for 1000 hrs with 1.5 hrs ON and 0.5 hr OFF.	±(1.0%+0.001Ω)
Load Life (Endurance)	JIS C 5201-1 clause 4.25	70±2°C, Rated power, or Max. working current whichever is less for 1000 hrs with 1.5 hrs ON and 0.5 hr OFF.	±(1.0%+0.001Ω)
Terminal Bending Strength	JIS C 5201-1, clause 4.33	Bending once for 5 seconds: 0402, 0603, 0805 = 5mm; 1206, 1210 = 3mm; 2010, 2512 = 2mm	±(1.0%+0.001Ω), No visible damage

SOLDERING

Wave solder

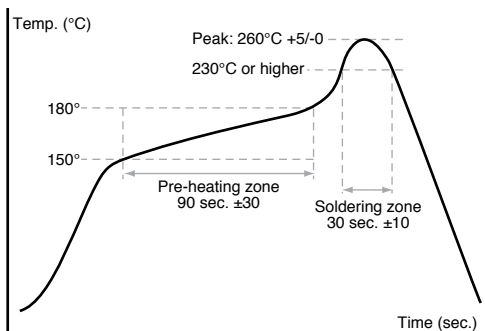

Solder reflow

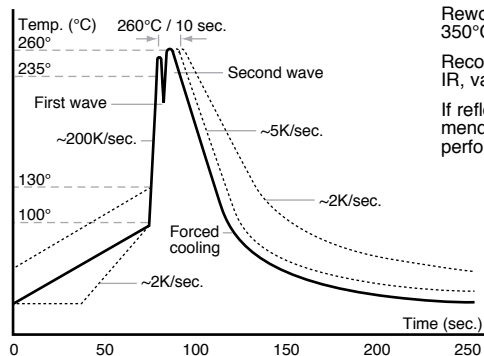

Rework temperature (hot air equipment):
350°C, 3~5seconds

Recommended reflow methods:
IR, vapor phase oven, hot air oven

If reflow temperatures exceed the recommended profile, devices may not meet the performance requirements.

KDV Series

Metal Film Low-Resistance Chip Resistor

TAPE AND REEL

(mm)

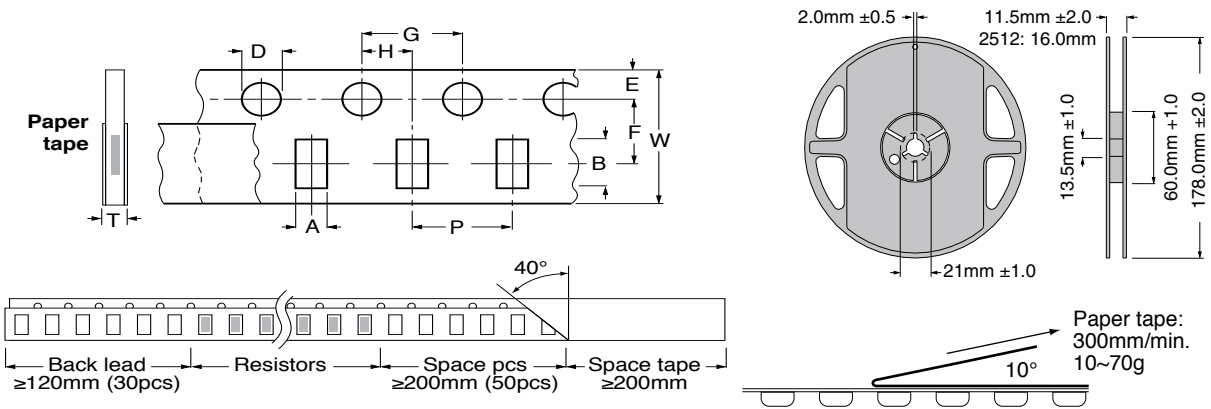

Size	A	B	W	E	F	G	H	T	D	P	Qty. per reel
KDV02	0.45 ±.1	0.75 ±.1	8.0 ±.2	1.75 ±.1	3.5 ±.05	4.0 ±.1	2.0 ±.05	0.35 ±.1	1.50 +.1/-0	2.0 ±.1	10K
KDV04	0.7 ±.1	1.20 ±.1	8.0 ±.2	1.75 ±.1	3.5 ±.05	4.0 ±.1	2.0 ±.05	0.45 ±.1	1.50 +.1/-0	2.0 ±.1	10K
KDV06	1.05 ±.2	1.80 ±.2	8.0 ±.2	1.75 ±.1	3.5 ±.05	4.0 ±.1	2.0 ±.05	0.60 ±.1	1.50 +.1/-0	4.0 ±.1	5K
KDV08	1.55 ±.2	2.30 ±.2	8.0 ±.2	1.75 ±.1	3.5 ±.05	4.0 ±.1	2.0 ±.05	0.75 ±.1	1.50 +.1/-0	4.0 ±.1	5K
KDV12	1.90 ±.2	3.05 ±.2	8.0 ±.2	1.75 ±.1	3.5 ±.05	4.0 ±.1	2.0 ±.05	0.75 ±.1	1.50 +.1/-0	4.0 ±.1	5K

ORDERING INFORMATION

Marking

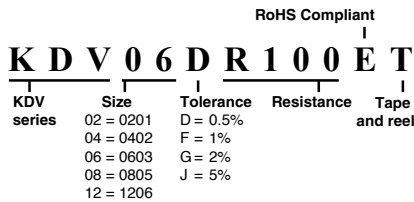

Size	Resistance	Code	Example	Value
0201, 0402			no marking	
0603	50mΩ ~ 99mΩ 100mΩ ~ 990mΩ 1000mΩ	OXX RXX 1R0	068 R68 1R0	68mΩ 680mΩ 1000mΩ
0805, 1206, 1210, 2010, 2512	50mΩ ~ 99mΩ (only for 0805,1206, 1210) 100mΩ ~ 990mΩ 1000mΩ	R0XX RXXX 1R00	R068 R680 1R00	68mΩ 680mΩ 1000mΩ

Standard part numbers

Ohm Value	Size	Power	Tolerance	Part. No.	0201 0.10W 0.5%	0201 0.10W 1%	0402 0.125W 0.5%	0402 0.125W 1%	0603 0.20W 0.5%	0603 0.20W 1%	0805 0.25W 0.5%	0805 0.25W 1%	1206 0.5W 0.5%	1206 0.5W 1%
					KDV02D-	KDV02F-	KDV04D-	KDV04F-	KDV06D-	KDV06F-	KDV08D-	KDV08F-	KDV12D-	KDV12F-
50mΩ				-R050ET		✓	✓	✓	✓	✓	✓	✓	✓	✓
68mΩ				-R068ET		✓	✓	✓	✓	✓	✓	✓	✓	✓
82mΩ				-R082ET		✓	✓	✓	✓	✓	✓	✓	✓	✓
100mΩ				-R100ET	✓		✓	✓	✓	✓	✓	✓	✓	✓
120mΩ				-R120ET	✓		✓	✓	✓	✓	✓	✓	✓	✓
150mΩ				-R150ET	✓		✓	✓	✓	✓	✓	✓	✓	✓
180mΩ				-R180ET	✓		✓	✓	✓	✓	✓	✓	✓	✓
200mΩ				-R200ET	✓		✓	✓	✓	✓	✓	✓	✓	✓
220mΩ				-R220ET	✓		✓	✓	✓	✓	✓	✓	✓	✓
240mΩ				-R240ET	✓		✓	✓	✓	✓	✓	✓	✓	✓
270mΩ				-R270ET	✓		✓	✓	✓	✓	✓	✓	✓	✓
300mΩ				-R300ET	✓		✓	✓	✓	✓	✓	✓	✓	✓
330mΩ				-R330ET	✓		✓	✓	✓	✓	✓	✓	✓	✓
360mΩ				-R360ET	✓		✓	✓	✓	✓	✓	✓	✓	✓
390mΩ				-R390ET	✓		✓	✓	✓	✓	✓	✓	✓	✓
470mΩ				-R470ET	✓		✓	✓	✓	✓	✓	✓	✓	✓
510mΩ				-R510ET	✓		✓	✓	✓	✓	✓	✓	✓	✓
560mΩ				-R560ET	✓		✓	✓	✓	✓	✓	✓	✓	✓
620mΩ				-R620ET	✓		✓	✓	✓	✓	✓	✓	✓	✓
820mΩ				-R820ET	✓		✓	✓	✓	✓	✓	✓	✓	✓