

Ultra High Precision Z1-Foil Resistor for Metrology and Laboratory with TCR of 0.5 ppm/°C Maximum, Tolerance to 0.005 % (50 ppm) and Load Life Stability of 0.005 % (50 ppm), + 70 °C for 10 000 h

INDUSTRY BREAKTHROUGH

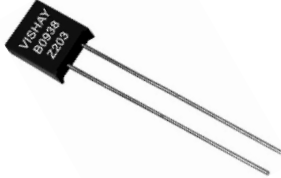

Z203 resistors are not restricted to standard values or minimum order quantity, and can be supplied from 1 unit with as-required values (e.g. 9.997 kΩ vs. 10 kΩ) at no extra cost or delivery time.

Our application engineering department is available to advise and to make recommendations. For non-standard technical requirements and special applications, please contact us.

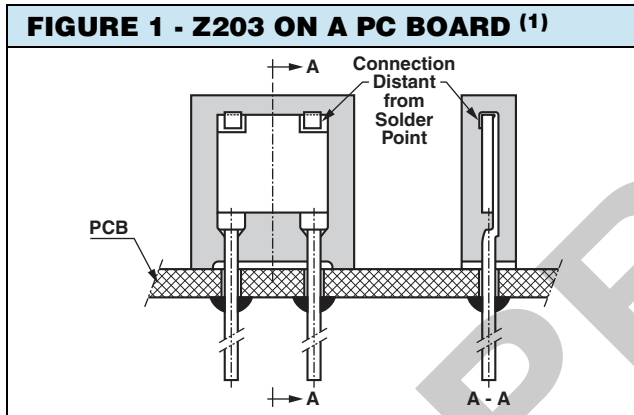

Note

(1) The leads on the Z203 connect to the Bulk Metal® Foil resistive element at the top of the package using solder-free, all welded construction. This high-reliability enhancement protects the terminations from initial board-assembly and subsequent board flexion stresses. The welded construction completely eliminates the possibility of latent failures due to solder reflow and solder-starved internal connections.

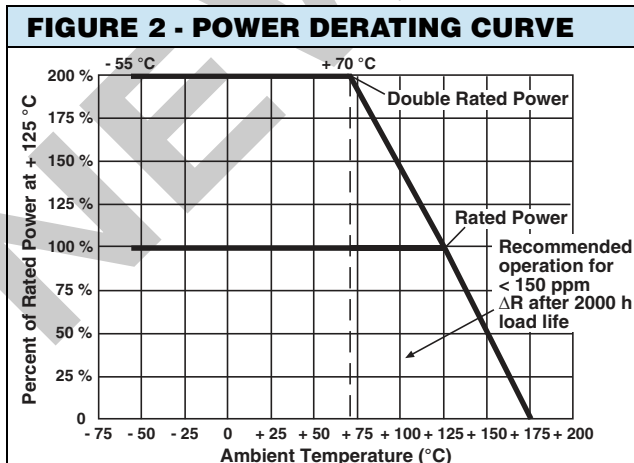

* Pb containing terminations are RoHS compliant, exemptions may apply

FEATURES

- Temperature coefficient of resistance (TCR): ± 0.5 ppm/°C maximum (+ 25 °C to + 125 °C)
- Power coefficient of resistance "ΔR due to self heating": ± 5 ppm at rated power
- Rated power: 0.6 W at 70 °C
0.3 W at 125 °C
- Resistance tolerance: to ± 0.005 % (50 ppm)
- Load life stability: to ± 0.005 % (50 ppm) at 70 °C, 10 000 h at 0.15 W
- Resistance range: 10 Ω to 100 kΩ
- Vishay Foil resistors are not restricted to standard values; specific "as-required" values can be supplied at no extra cost or delivery (e.g. 1K2345 vs. 1K)
- Electrostatic discharge (ESD) up to 25 000 V
- Non-inductive, non-capacitive design
- Rise time: 1 ns, effectively no ringing
- Current noise: 0.010 μV_{RMS}/V of applied voltage (< - 40 dB)
- Thermal EMF: 0.1 μV/°C max.
- Thermal stabilization time < 1 s (nominal value achieved within 10 ppm of steady state value)
- Voltage coefficient: < 0.1 ppm/V
- Non-inductive: 0.08 μH
- Terminal finish: lead (Pb)-free or tin/lead alloy
- Maximum working voltage: 300 V
- Drop in replacement for S102C/K
- Matched sets are available per request
- Prototype quantities available in just 5 working days or sooner. For more information, please contact foil@vishaypg.com
- For better performances please contact us
- Compliant to RoHS directive 2002/95/EC



RoHS*
COMPLIANT

TABLE 1 - TOLERANCE AND TCR VS. RESISTANCE

VALUE	STANDARD TOLERANCE (%)	TYP. TCR AND MAX. SPREAD (ppm/°C) (+ 25 °C to + 125 °C)	TYP. TCR AND MAX. SPREAD (ppm/°C) (- 55 °C to + 25 °C)
100 Ω to 100 kΩ	± 0.005 %	± 0.2 ± 0.3	± 0.2 ± 1.8
80 Ω to < 100 Ω	± 0.005 %	± 0.2 ± 0.4	± 0.2 ± 2.0
50 Ω to < 80 Ω	± 0.01 %	± 0.2 ± 0.6	± 0.2 ± 2.3
25 Ω to < 50 Ω	± 0.01 %	± 0.2 ± 0.8	± 0.2 ± 2.6
10 Ω to < 25 Ω	± 0.02 %	± 0.2 ± 1.0	± 0.2 ± 2.8

ABOUT Z203

Vishay's new generation of metrology ultra-high precision Z-Foil resistor features new orders of accuracy, stability and fast thermal stabilization in sizes small enough for permanent assembly in operational equipment. This is, place metrology-grade resistors right into the equipment as on-board reference standards. Vishay's Z203 unit offers an immediate answer to many resistor applications currently believed unsolvable, and opens entirely new areas of design where the use of resistors had not been considered.

Applications include:

- Secondary standards
- Feedback devices for operational amplifiers
- Precision voltage dividers
- Meter multipliers
- Precision bridge resistors
- Decade voltage dividers

The performance of Vishay's Z203 resistor cannot be equaled by any conventional resistor technologies, or by bulky units now used as standards. As shown by the specifications on table 2 and 3, there is no compromise between precision and speed (as in wirewound units) or between speed and the combination of excellent precision, stability and TCR (as with conventional deposited films).

The Z203 is the result of a unique concept in resistor manufacturing. A proprietary new generation of the Bulk Metal® Z-Foil element with known and controllable properties is applied to a special ceramic substrate. A resistive pattern is then photoetched by an ultra-fine technique developed by Vishay. The device's etched planar construction results in the extremely low and reproducible reactance needed for high-frequency and pulse applications.

Z203 is uniquely enhanced by post manufacturing operations (PMO) exercised after the manufacturing cycle has been completed. Some of these exercises are a standard part of the manufacturing cycle and are only repeated during the PMO cycle to gain added stability or confidence in the product. The foil resistor load-life curve shows an increase in resistance from the first load application, but flattens out to no further change after the first few hundred hours of loading. This knee in the load-life curve is reduced significantly by a special accelerated load-life operation performed by Vishay, resulting in a flat response immediately after installation. Other resistive devices show a continuous change when subjected to these same stresses and are driven out of tolerance.

The optional PMO for this product includes the combination of thermal shock, power shot and special burn-in.

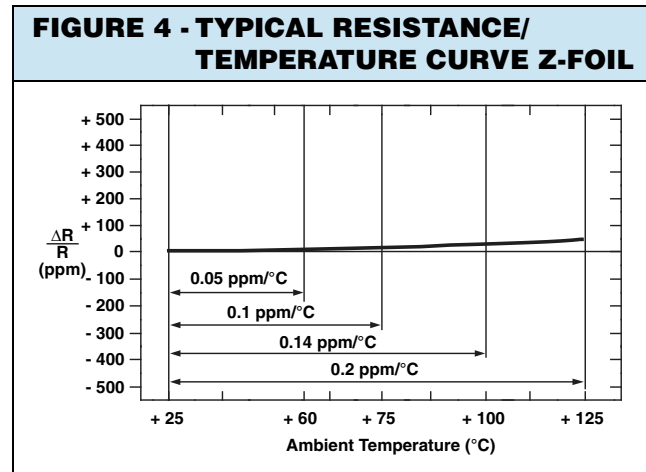
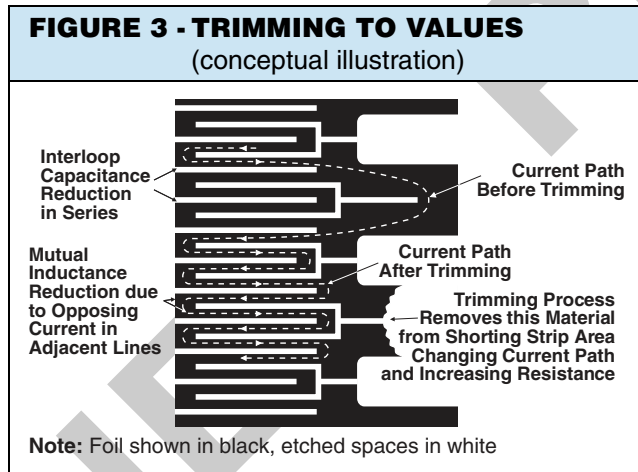
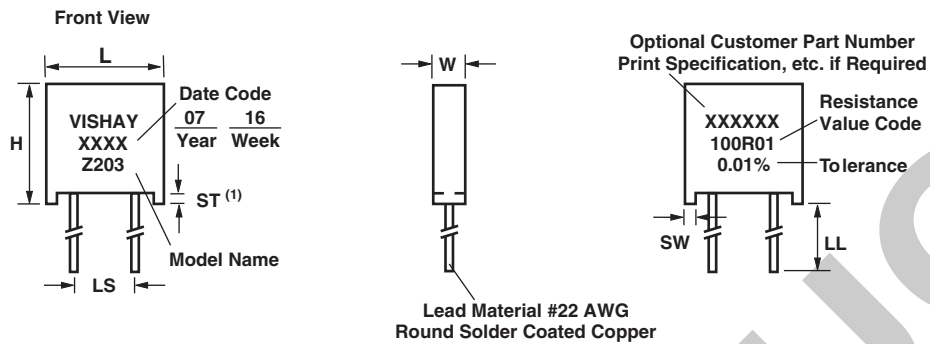

FIGURE 5 - STANDARD IMPRINTING AND DIMENSIONS



		LS	W	L	H	ST	SW	LL
Z203	inches	0.150 ± 0.005	0.105 ± 0.010 2.67 ± 0.25	0.300 ± 0.010 7.62 ± 0.25	0.326 ± 0.010 8.28 ± 0.25	0.010 min 0.254 min	0.035 ± 0.01 1.02 ± 0.13	1.000 ± 0.125 25.4 ± 3.18
	mm	3.81 ± 0.13						
Z203L	inches	0.200 ± 0.005	0.105 ± 0.010 2.67 ± 0.25	0.300 ± 0.010 7.62 ± 0.25	0.326 ± 0.010 8.28 ± 0.25	0.010 min 0.254 min	0.035 ± 0.01 1.02 ± 0.13	1.000 ± 0.125 25.4 ± 3.18
	mm	5.08 ± 0.13						

Note

(1) The standoffs shall be so located as to give a lead clearance of 0.010" minimum between the resistor body and the printed circuit board when the standoffs are seated on the printed circuit board. This is to allow for proper cleaning of flux and other contaminants from the unit after all soldering processes

TABLE 2 - Z203 SPECIFICATIONS

Load Life Stability	TYPICAL	MAXIMUM
0.3 W at + 125 °C/0.6 W at + 70 °C		
2000 h	± 0.005 % (50 ppm)	± 0.015 % (150 ppm)
10 000 h	± 0.015 % (150 ppm)	± 0.05 % (500 ppm)
0.15 W at + 70 °C		
2000 h	± 0.002 % (20 ppm)	± 0.01 % (100 ppm)
10 000 h	± 0.005 % (50 ppm)	± 0.015 % (150 ppm)

TABLE 3 - ENVIRONMENTAL PERFORMANCE COMPARISON

	VISHAY Z203	
	TYPICAL ΔR	MAXIMUM ΔR
Test Group I Thermal Shock, 5 x (- 65 °C to + 150 °C) Short Time Overload, 5 s (6.25 x rated power)	$\pm 0.002\%$ (20 ppm) $\pm 0.003\%$ (30 ppm)	$\pm 0.01\%$ (100 ppm) $\pm 0.01\%$ (100 ppm)
Test Group II Resistance Temperature Characteristic Low Temperature Storage (25 h at - 65 °C) Low Temperature Operation (45 min, rated power at - 65 °C) Terminal Strength	see table 1 $\pm 0.002\%$ (20 ppm) $\pm 0.002\%$ (20 ppm) $\pm 0.002\%$ (20 ppm)	see table 1 $\pm 0.01\%$ (100 ppm) $\pm 0.01\%$ (100 ppm) $\pm 0.01\%$ (100 ppm)
Test Group III DWV Resistance to Solder Heat, 20 s at + 260 °C Moisture Resistance	$\pm 0.002\%$ (20 ppm) $\pm 0.005\%$ (50 ppm) $\pm 0.01\%$ (100 ppm)	$\pm 0.01\%$ (100 ppm) $\pm 0.01\%$ (100 ppm) $\pm 0.05\%$ (500 ppm)
Test Group IV Shock Vibration	$\pm 0.002\%$ (20 ppm) $\pm 0.002\%$ (20 ppm)	$\pm 0.01\%$ (100 ppm) $\pm 0.01\%$ (100 ppm)
Test Group V Life Test at 0.3 W/+ 125 °C 2000 h 10 000 h	$\pm 0.005\%$ (50 ppm) $\pm 0.015\%$ (150 ppm)	$\pm 0.015\%$ (150 ppm) $\pm 0.05\%$ (500 ppm)
Test Group Va Life Test at 0.6 W (2 x Rated Power)/+ 70 °C, 2000 h	$\pm 0.005\%$ (50 ppm)	$\pm 0.015\%$ (150 ppm)
Test Group VI High Temperature Exposure, 2000 h at + 150 °C	$\pm 0.05\%$ (500 ppm)	$\pm 0.1\%$ (1000 ppm)
Test Group VII Voltage Coefficient	< 0.00001 %/V	< 0.00001 %/V

STANDARD MEASUREMENT (at room temperature)**Standard Test Conditions:**

- Temperature: + 23 °C \pm 2 °C
- Relative humidity: 35 % to 65 % RH
- Lead test point: 0.5" (12.7 mm) from resistor body

POST MANUFACTURING OPERATIONS (PMO) FOR IMPROVED END OF LIFE

Many analog applications can include requirements for performance under conditions of stress beyond the norm and over extended periods of time. This calls for more than just selecting a standard device and applying it to a circuit. The standard device may turn out to be all that is needed but an analysis of the projected service conditions should be made and it may well dictate a routine of stabilization known as post manufacturing operations or PMO. The PMO operations that will be discussed are only applicable to Bulk Metal Foil resistors. They stabilize Bulk Metal Foil resistors while they may be harmful to other types. Short time overload, accelerated load life, and temperature cycling are the three PMO methods that do the most to remove the anomalies down the road. Vishay Bulk Metal Foil resistors are inherently stable as manufactured. These PMO methods are only of value on Bulk Metal Foil resistors and they improve the performance by amounts that are small but significant when compared to the very tight tolerances. Users are encouraged to contact Vishay Foil applications engineering for assistance in choosing the PMO operations that are right for their application.

TABLE 4 - GLOBAL PART NUMBER INFORMATION (1)

NEW GLOBAL PART NUMBER: Y1445250R000V9L (preferred part number format)

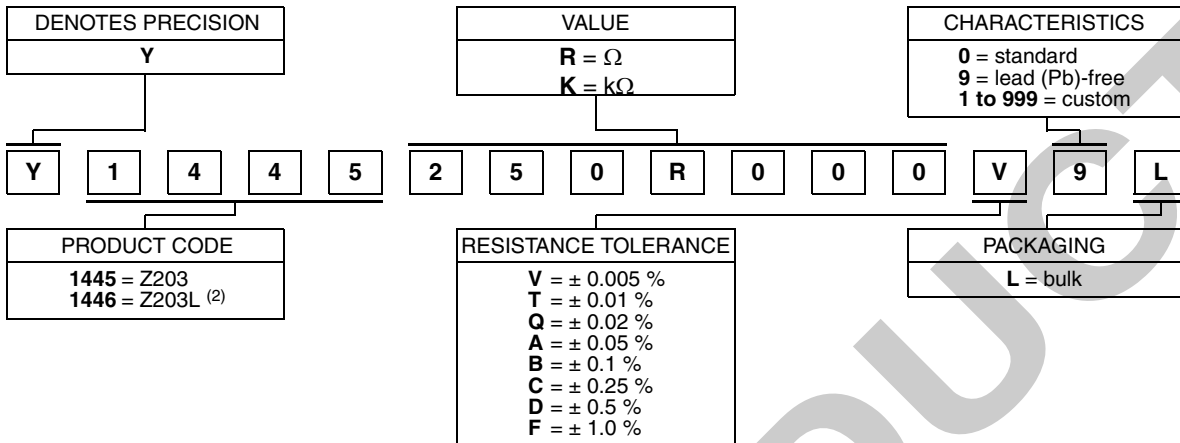

FOR EXAMPLE: ABOVE GLOBAL ORDER Y1445 250R000 V 9 L:

TYPE: Z203
VALUE: 250.0 Ω
ABSOLUTE TOLERANCE: $\pm 0.005\%$
TERMINATION: lead (Pb)-free
PACKAGING: bulk

HISTORICAL PART NUMBER: Z203T 250R00 V B (will continue to be used)

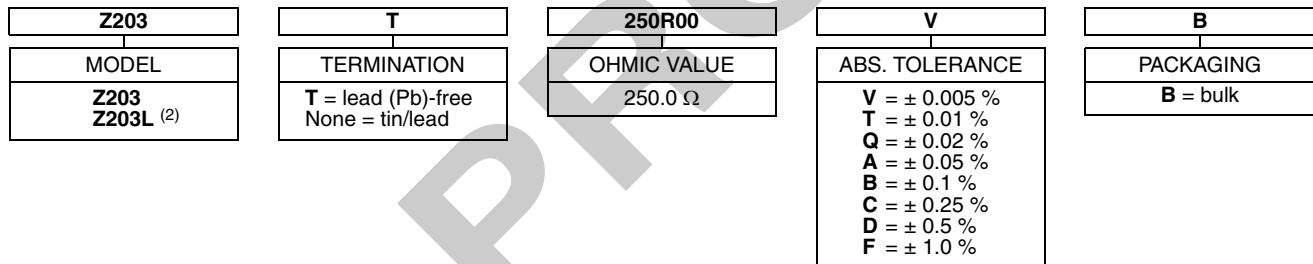

Notes

- (1) For non-standard requests, please contact application engineering
- (2) See figure 5

Disclaimer

ALL PRODUCTS, PRODUCT SPECIFICATIONS AND DATA ARE SUBJECT TO CHANGE WITHOUT NOTICE.

Vishay Precision Group, Inc., its affiliates, agents, and employees, and all persons acting on its or their behalf (collectively, "VPG"), disclaim any and all liability for any errors, inaccuracies or incompleteness contained herein or in any other disclosure relating to any product.

The product specifications do not expand or otherwise modify VPG's terms and conditions of purchase, including but not limited to, the warranty expressed therein.

VPG makes no warranty, representation or guarantee other than as set forth in the terms and conditions of purchase. **To the maximum extent permitted by applicable law, VPG disclaims (i) any and all liability arising out of the application or use of any product, (ii) any and all liability, including without limitation special, consequential or incidental damages, and (iii) any and all implied warranties, including warranties of fitness for particular purpose, non-infringement and merchantability.**

Information provided in datasheets and/or specifications may vary from actual results in different applications and performance may vary over time. Statements regarding the suitability of products for certain types of applications are based on VPG's knowledge of typical requirements that are often placed on VPG products. It is the customer's responsibility to validate that a particular product with the properties described in the product specification is suitable for use in a particular application. You should ensure you have the current version of the relevant information by contacting VPG prior to performing installation or use of the product, such as on our website at vpgsensors.com.

No license, express, implied, or otherwise, to any intellectual property rights is granted by this document, or by any conduct of VPG.

The products shown herein are not designed for use in life-saving or life-sustaining applications unless otherwise expressly indicated. Customers using or selling VPG products not expressly indicated for use in such applications do so entirely at their own risk and agree to fully indemnify VPG for any damages arising or resulting from such use or sale. Please contact authorized VPG personnel to obtain written terms and conditions regarding products designed for such applications.

Product names and markings noted herein may be trademarks of their respective owners.

Copyright Vishay Precision Group, Inc., 2014. All rights reserved.