

# Isolated Flyback Type PWM Mode BM1P10CFJ Evaluation Board

## <High Voltage Safety Precautions>

◇ Read all safety precautions before use

Please note that this document covers only the BM1P10CFJ evaluation board (BM1P10CFJ-EVK-001) and its functions. For additional information, please refer to the datasheet.

**To ensure safe operation, please carefully read all precautions before handling the evaluation board**



Depending on the configuration of the board and voltages used,

**Potentially lethal voltages may be generated.**

Therefore, please make sure to read and observe all safety precautions described in the red box below.

### Before Use

- [1] Verify that the parts/components are not damaged or missing (i.e. due to the drops).
- [2] Check that there are no conductive foreign objects on the board.
- [3] Be careful when performing soldering on the module and/or evaluation board to ensure that solder splash does not occur.
- [4] Check that there is no condensation or water droplets on the circuit board.

### During Use

- [5] Be careful to not allow conductive objects to come into contact with the board.
- [6] **Brief accidental contact or even bringing your hand close to the board may result in discharge and lead to severe injury or death.**

**Therefore, DO NOT touch the board with your bare hands or bring them too close to the board.**

In addition, as mentioned above please exercise extreme caution when using conductive tools such as tweezers and screwdrivers.

- [7] If used under conditions beyond its rated voltage, it may cause defects such as short-circuit or, depending on the circumstances, explosion or other permanent damages.
- [8] Be sure to wear insulated gloves when handling is required during operation.

### After Use

- [9] The ROHM Evaluation Board contains the circuits which store the high voltage. Since it stores the charges even after the connected power circuits are cut, please discharge the electricity after using it, and please deal with it after confirming such electric discharge.
- [10] Protect against electric shocks by wearing insulated gloves when handling.

This evaluation board is intended for use only in research and development facilities and should be handled **only by qualified personnel familiar with all safety and operating procedures.**

We recommend carrying out operation in a safe environment that includes the use of high voltage signage at all entrances, safety interlocks, and protective glasses.

AC/DC Converter

# Isolated Flyback Type PWM Mode 48W 24V Output BM1P10CFJ Evaluation Board

BM1P10CFJ-EVK-001

**General Description**

- (1) Standby mode significantly reduces standby power consumption.
- (2) Spacing-saving is realized by MOSFET, start circuit incorporation.
- (3) It realizes the high flexibility because current sense resistance adjustment is possible.
- (4) Voltage = 45V or less one second after the cutting are realized by X condenser electric discharge function incorporation.
- (5) Electricity is reduced at no load time by power save function incorporation.
- (6) Efficiency in the light load is improved largely by burst movement, a frequency reduction mode.



Figure 1. BM1P10CFJ-EVK-001

**Performance Specification**

**Operating Range**

Parameter	Symbol	Min	Typ	Max	Units	Conditions
Input Voltage Range	$V_{IN}$	90	230	264	V	
Input Frequency	$f_{LINE}$	47	-	63	Hz	
Operating Temperature Range	$T_{op}$	-10	+25	+65	°C	

Performance Specification – Continued

Electrical characteristic

Not guarantee the characteristics is representative value.

Unless otherwise specified  $V_{IN} = 230 \text{ Vac}$  ,  $I_{OUT} = 2 \text{ A}$  ,  $V_{STBY} = 5\text{V}$  ,  $T_a = 25 \text{ }^\circ\text{C}$

Parameter	Symbol	Min	Typ	Max	Units	Conditions
Operating Start Input Voltage	$V_{INST}$	-	70	-	V	
Output Voltage	$V_{OUT}$	22.8	24	25.2	V	
Maximum Output Power	$P_{OUT}$	-	-	48	W	$I_{OUT} = 2 \text{ A}$
Output Current Range <sup>(Note 1)</sup>	$I_O$	0	-	2	A	
Output Voltage at Standby	$V_{OUTSTBY}$	7.1	7.5	7.9	V	$V_{STBY} = 0 \text{ V}$
Output Current at Standby	$I_{OSTBY}$	0		2	A	$V_{STBY} = 0 \text{ V}$
Wait electricity	$P_{INSTBY}$	-	40	-	mW	$I_{OUT} = 0 \text{ A}$ $V_{STBY} = 0 \text{ V}$
Power supply efficiency	$\eta$	86	89.6	-	%	
Output Ripple Voltage <sup>(Note 2)</sup>	$V_{PP}$	-	60	240	mVpp	

(Note 1) Please adjust operating time , within any parts surface temperature under 105 °C.

(Note 2) Not include spikes noise

Derating

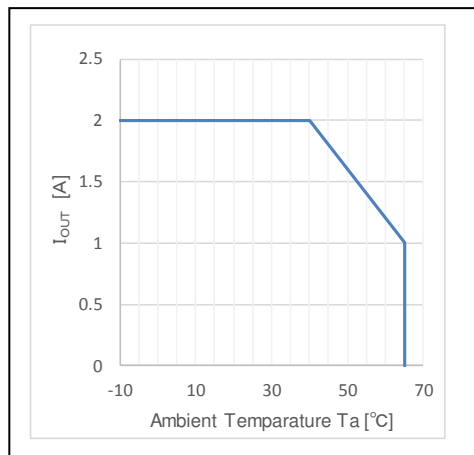

Figure 2. Derating

## Operation Procedure

### 1 Necessary Equipment

- (1) AC power supply (90 Vac to 264 Vac, 100 W or more)
- (2) Load equipment (5 A at maximum value)
- (3) DC voltmeter
- (4) Wattmeter
- (5) 5V power supply (10 mA)

### 2 Connect to Each Equipment

- (1) Connect a measuring instrument to Figure 3 reference as each power supply OFF.
- (2) Set the AC power supply to 90 Vac to 264 Vac, and power supply ON.
- (3) In the case of electronic load, load sets it between 0 A to 2A, and power supply ON.
- (4) The DC voltmeter of the output connects with directly outputting it, and confirm the voltage.
- (5) Connect STBY pin and GND pin to DC power supply. and apply +5V. The output voltage is 24V.

The output voltage becomes 7.5V when it is 0V. Set the input voltage of the STBY pin on less than +8V.

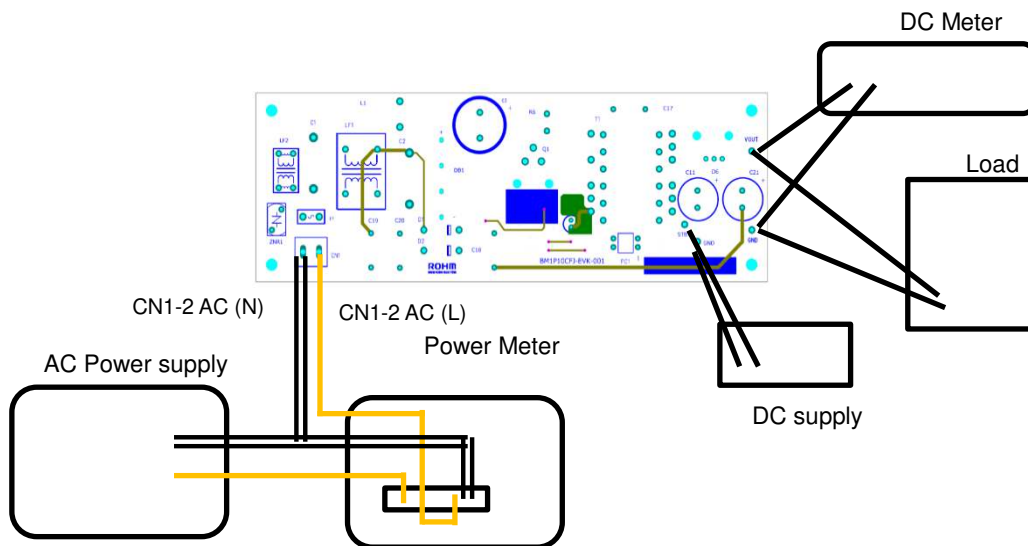

Figure 3. Diagram of How to Connect

Application Circuit

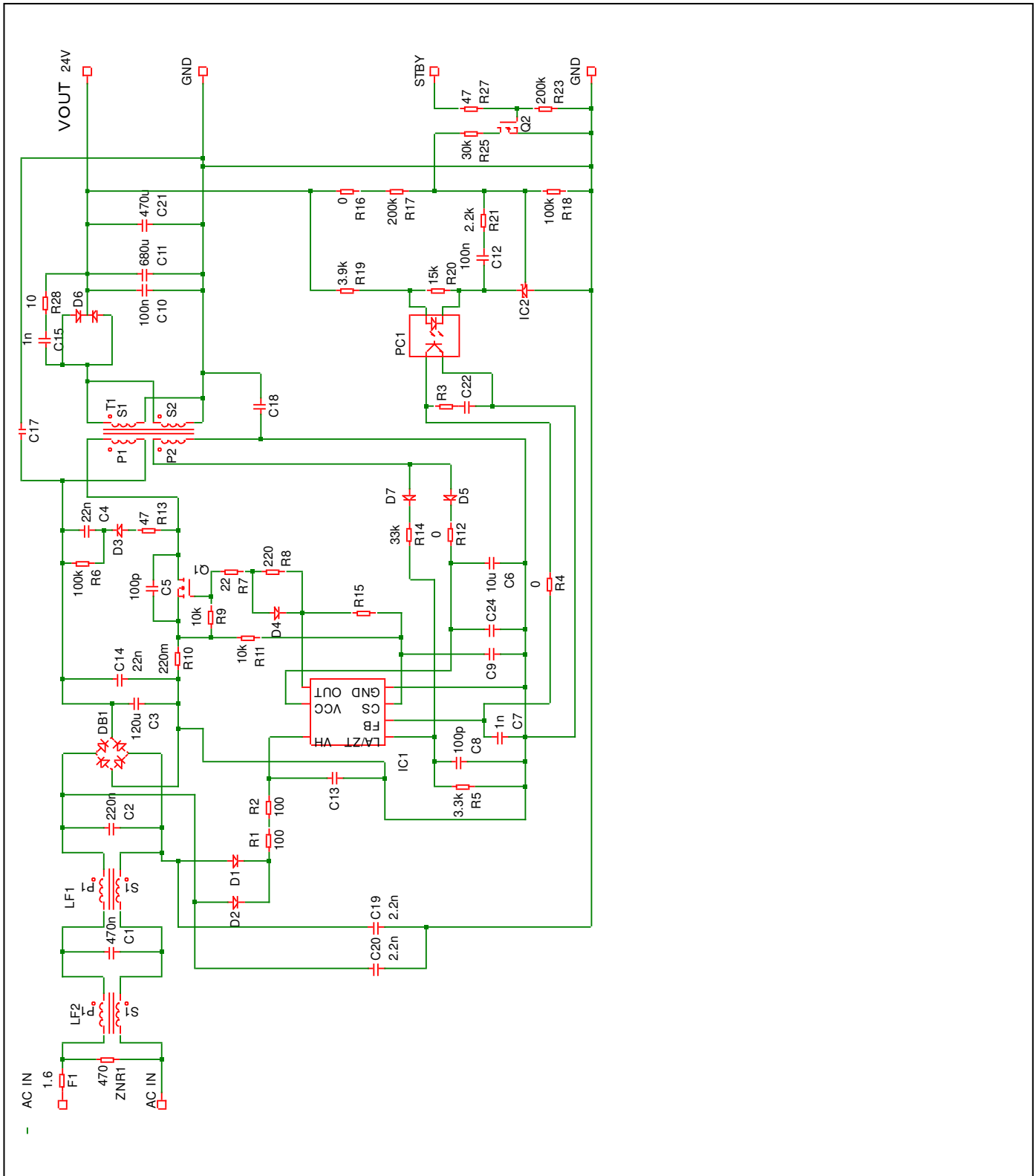

Figure 4. Application Circuit

## Parts List

Materials may be changed without notifying.

	Item	Specifications	Parts name	Manufacture
Capacitor	C1	470 n, 310 Vac	890334025039CS	WURTH ELECTRONIK
	C2	220 n, 310 Vac	890334025027CS	WURTH ELECTRONIK
	C3	120 $\mu$ , 450 V	450CXW120MEFC18x31.5	RUBYCON
	C4	22 nF, 630 V	885342208014	WURTH ELECTRONIK
	C5	100 p, 1000 V	885342208022	WURTH ELECTRONIK
	C6	10 $\mu$ F, 63 V	860080772001	WURTH ELECTRONIK
	C7	1000 pF, 100 V	HMK107B7102KA-T	TAIYO YUDEN
	C8	100 p, 100 V	885012206102	WURTH ELECTRONIK
	C10	0.1 $\mu$ F, 100 V	HMK107B7104KA-T	TAIYO YUDEN
	C11	680 $\mu$ F, 35 V	860080578019	WURTH ELECTRONIK
	C12	0.1 $\mu$ F, 100 V	HMK107B7104KA-T	TAIYO YUDEN
	C9,C13,C18,C22,C24	NON MOUNTED	-	-
	C14	22 nF, 630 V	885342208014	WURTH ELECTRONIK
	C15	1 n, 630 V	885342208011	WURTH ELECTRONIK
	C17	2200 pF, AC 500 V	DE1E3RA222MA4BP01F	MURATA
	C19	2200 pF, AC 500 V	DE1E3RA222MA4BP01F	MURATA
	C20	2200 pF, AC 500 V	DE1E3RA222MA4BP01F	MURATA
	C21	470 $\mu$ F, 35 V	860080575017	WURTH ELECTRONIK
	Diode	D1	1 A, 1000 V	1N4007
D2		1 A, 1000 V	1N4007	MCCSEMI
D3		FRD, 0.8 A, 700 V	RFN1LAM7S	ROHM
D4		FRD, 0.5 A, 200 V	RF05VAM2S	ROHM
D5		FRD, 600 V, 0.2 A	RFU02VSM6S	ROHM
D6		FRD, 200 V, 20 A	RF2001T2DNZ	ROHM
D7		FRD, 600 V, 0.2 A	RFU02VSM6S	ROHM
Opto-Coupler	PC1		LTV-817-B	LITEON
MOSFET	Q1	800 V, 9 A	R8009KNX	ROHM
	Q2	20 V, 0.1 A	RU1C001UN	ROHM
Diode-Brigde	DB1	800 V, 10 A	D10XB80	SHINDENGEN

## Parts List - continued

	Item	Specifications	Parts name	Manufacture
Resistor	R1	100 $\Omega$	ESR18EZPJ101	ROHM
	R2	100 $\Omega$	ESR18EZPJ101	ROHM
	R3,R15	NON MOUNTED	-	-
	R4	0 $\Omega$	MCR03EZPJ000	ROHM
	R5	3.3 k $\Omega$	MCR03EZPJ332	ROHM
	R6	100 k $\Omega$	MOS2CT52R104J	KOA
	R7	22 $\Omega$	ESR18EZPJ220	ROHM
	R8	220 $\Omega$	MCR03EZPJ221	ROHM
	R9	10 k $\Omega$	MCR03EZPJ103	ROHM
	R10	220 m $\Omega$	LTR50EZPZFLR220	ROHM
	R11	10 k $\Omega$	ESR18EZPJ103	ROHM
	R12	0 $\Omega$	MCR18EZPJ000	ROHM
	R13	47 $\Omega$	ESR18EZPJ470	ROHM
	R14	33 k $\Omega$	MCR03EZPJ333	ROHM
	R16	0 $\Omega$	MCR03EZPJ000	ROHM
	R17	200 k $\Omega$	MCR03EZPF2003	ROHM
	R18	100 k $\Omega$	MCR03EZPF1003	ROHM
	R19	3.9 k $\Omega$	MCR03EZPJ392	ROHM
	R20	15 k $\Omega$	MCR03EZPJ153	ROHM
	R21	2.2 k $\Omega$	MCR03EZPJ222	ROHM
R23	200 k $\Omega$	MCR03EZPJ204	ROHM	
R25	30 k $\Omega$	MCR03EZPF3002	ROHM	
R27	47 $\Omega$	MCR03EZPJ470	ROHM	
R28	10 $\Omega$	ESR18EZPJ100	ROHM	
Fuse	F1	1.6 A, 300 V	36911600000	LITTELFUSE
Varistor	ZNR1	300 V, 400 A	V470ZA05P	LITTELFUSE
Coil	LF1	34.5 mH	SSR21NV-M12345	KMENT
	LF2	60 $\mu$ H	LF1246Y	ALPHA TRANS
Transformer	T1	PQ 26	XE2395Y	ALPHA TRANS
IC	IC1		BM1P10CFJ	ROHM
	IC3		NCP431AVSNT1G	ONSEMI



## Parts List - continued

	Item	Specifications	Parts name	Manufacture
Heatshink	HEAT1	22.9 k/W	IC-1625-STL	SANKYO THRMOTECH
	HEAT2	22.9 k/W	IC-1625-STL	SANKYO THRMOTECH
Connector	CN1		B02P – NV	JST
Pin	TP1~4		CD-10-15	MAC8

Layout

Size: 160 mm x 55 mm

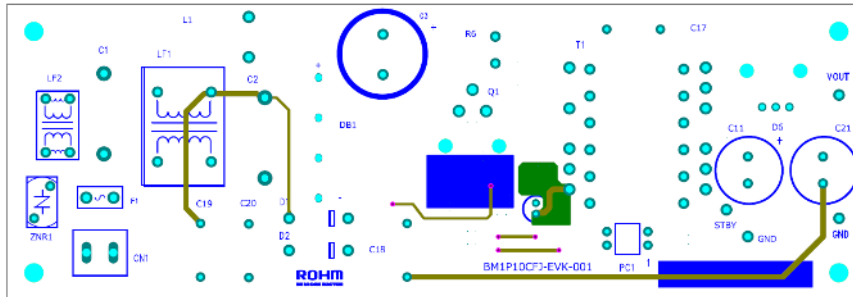

Figure 5. TOP Silkscreen (Top view)

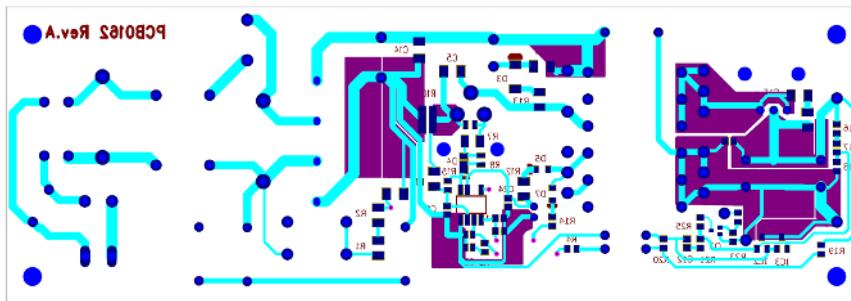

Figure 6 .Bottom Layout (Top View)

## BM1P10CFJ - General Description

### Features

- AC Low Voltage Protection Function (AC UVLO)
- X Capacitor Discharge Function
- VCC Pin Low Voltage Protection (VCC UVLO)
- PWM Type Current Mode Control
- Frequency Reduction Function
- Burst Operation at Light Load
- Switching Function of Operation Modes
- Power Save Function  
(Low Consumption Current at no load)
- Soft Start Function
- FB Pin Overload Protection Function (FB OLP)
- CS Pin Overload Protection Function (CS OLP)
- Switching Function of CS OLP Detection Voltage
- CS Pin Over Current Protection Function (CS OCP)
- CS Pin Leading Edge Blanking Function
- LA/ZT Pin Over Voltage Protection Function (ZT OVP)
- OUT Pin Gate Clamp Circuit

### Key Specifications

- Operation Power Supply Voltage Range
  - VCC Pin Voltage: 9.3 V to 55.0 V
  - VH Pin Voltage: 650 V (Max)
- Current at Switching Operation: 0.70 mA (Typ)
- Current at Burst Operation: 0.35 mA (Typ)
- Current at Power Save Operation: 0.11 mA (Typ)
- Switching Frequency: 100 kHz (Typ)
- Operation Temperature Range: -40 °C ~ +105 °C

### Package

SOP-J7S

W (Typ) x D (Typ) x H (Max)

4.9 mm x 6.0 mm x 1.65 mm

Pitch: 1.27 mm (Typ)



### Applications

OA Equipment, AC Adapters, Each Household Applications and Power Supplies for Motor

### Pin Configuration

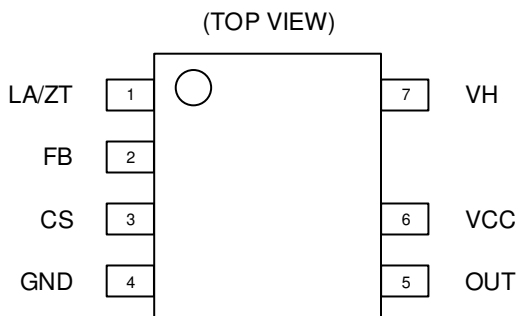

### Pin Descriptions

No.	Pin Name	I/O	Function
1	LA/ZT	I	Monitor auxiliary winding / Latch stop pin
2	FB	I	Feedback signal input pin
3	CS	I	Primary current detection pin
4	GND	-	GND pin
5	OUT	O	External MOSFET drive pin
6	VCC	I	Power supply input pin
7	VH	I	Startup power supply input / AC input voltage monitor pin

BM1P10CFJ General Description – continued

Specification of the Transformer

Manufacture Alphatrans Co., Ltd. (1-7-2, Bakurou-cho, Chuo-ku, Osaka City, 541-0059, Japan)  
<http://www.alphatrans.jp/>

Product Name: XE2395Y  
 Bobbin: 12PIN  
 Core: PQQ2620

- Primary Inductance: 0.50mH± 10 %  
(100 kHz, 1 V)
- Voltage Endurance
  - Between Primary and Secondary : AC1500 V
  - Between Primary and Core: AC1500 V
  - Between Secondary and Core: AC500 V
- Isolated Resistor 100 MΩ or more (DC500 V)

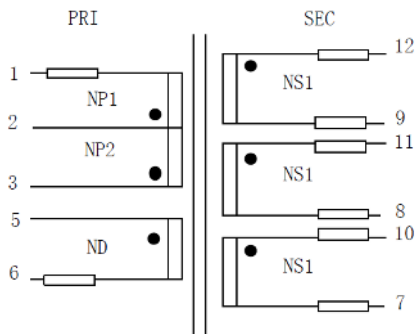

Figure 7. Circuit Diagram

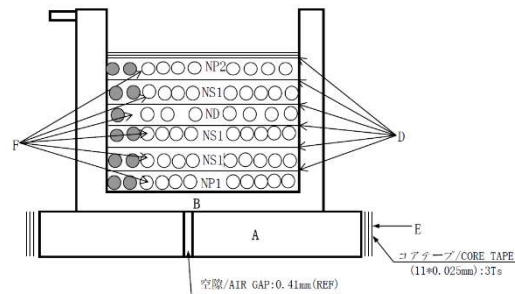

Figure 8. Structure Diagram

Table 1. Product Specification of XE2395Y

No.	Transformer	Winding Pin		Wire	Turn Number	Tape Layer	Wire Specification
		Start	Finish				
1	NP1	3	2	2UEW / Φ0.29 x 2	19	1	COMPACT
2	NS1	10	7	TEX / Φ0.32 x 2	11	1	COMPACT
3	NS1	11	8	TEX / Φ0.32 x 2	11	1	COMPACT
4	ND	5	6	2UEW / Φ0.15 x 1	20	1	COMPACT
5	NS1	8	7	TEX / Φ0.32 x 2	11	1	COMPACT
6	NP2	2	1	2UEW / Φ0.29 x 2	19	3	COMPACT

Measurement Data

1 Load Regulation

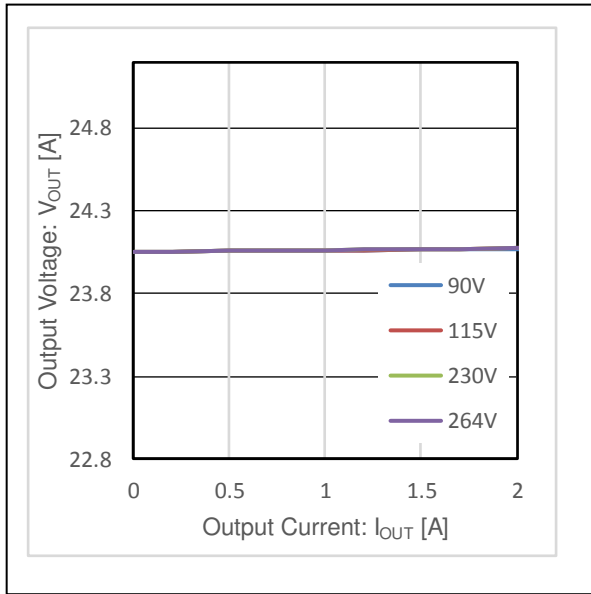

Figure 9. Regulation ( $V_{OUT}$  vs  $I_{OUT}$ )

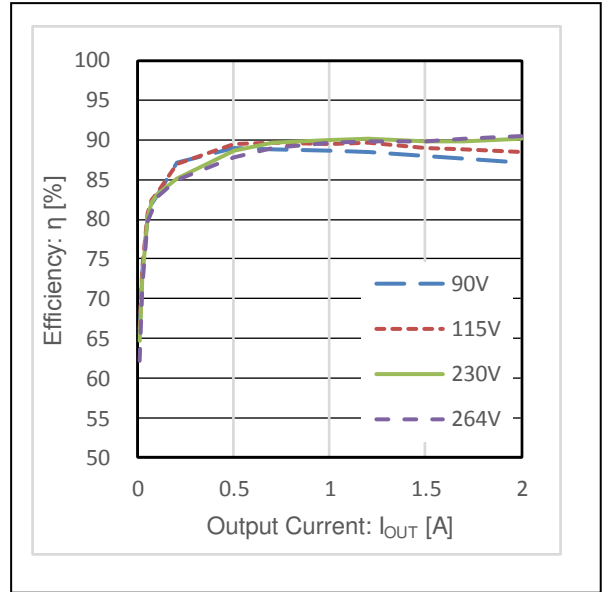

Figure 10. Load Regulation (Efficiency vs  $I_{OUT}$ )

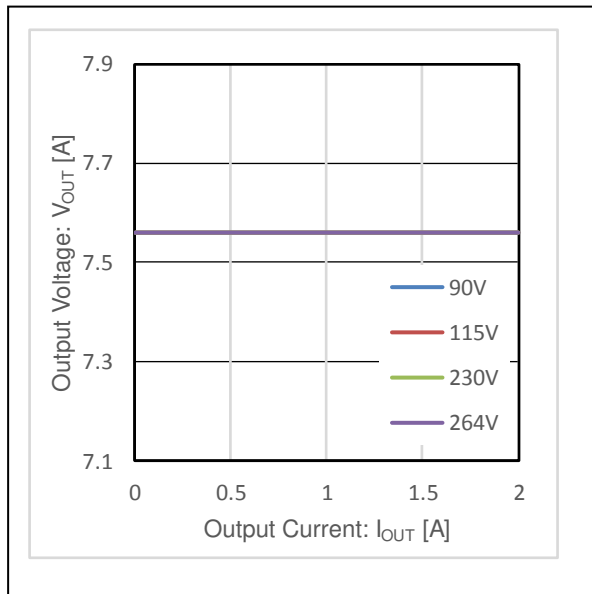

Figure 11. Load Regulation ( $V_{OUT}$  vs  $I_{OUT}$ )

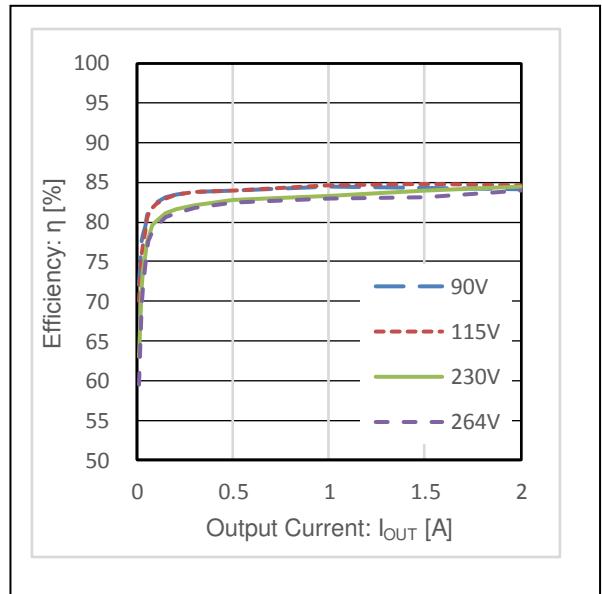

Figure 12. Load Regulation (Efficiency vs  $I_{OUT}$ )

Measurement Data – continued

1 Load Regulation

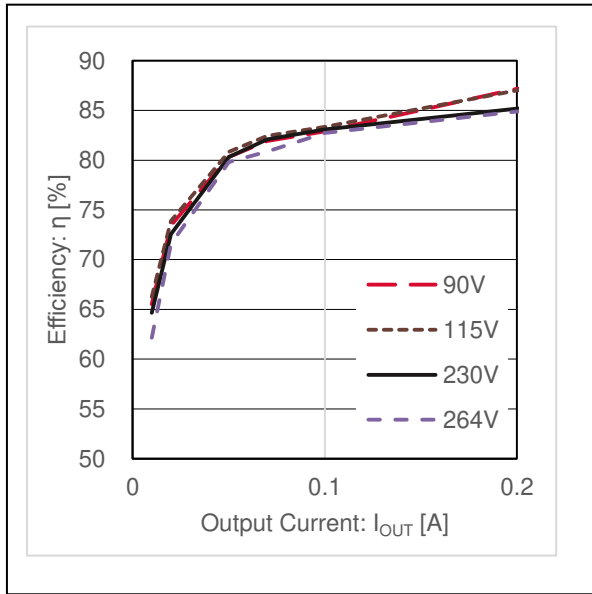

Figure 13. Load Regulation ( $V_{OUT}$  vs  $I_{OUT}$  at  $V_{OUT}$  24 V)

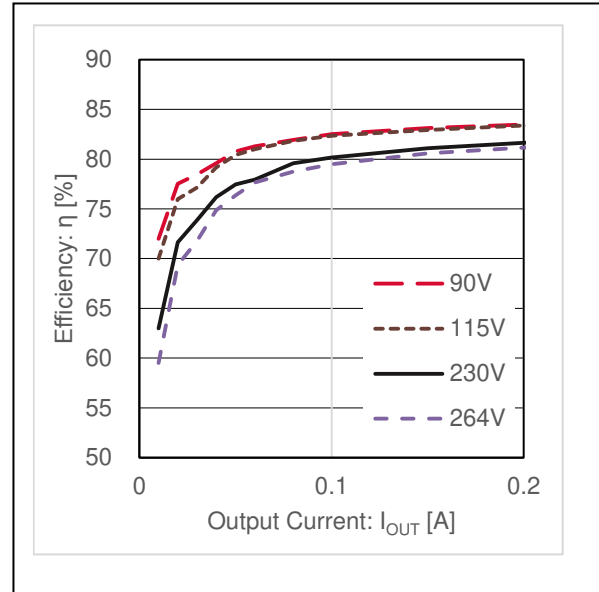

Figure 14. Load Regulation (Efficiency vs  $I_{OUT}$  at  $V_{OUT}$  7.5V)

2 Line Regulation

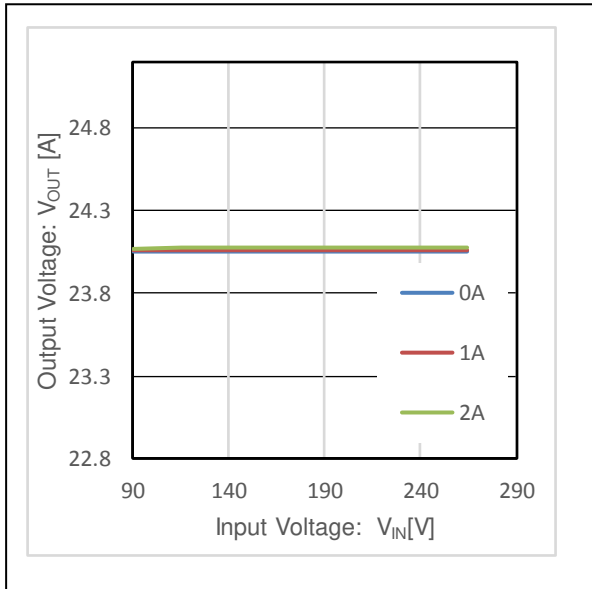

Figure 15. Line Regulation ( $V_{OUT}$  vs  $V_{IN}$ )

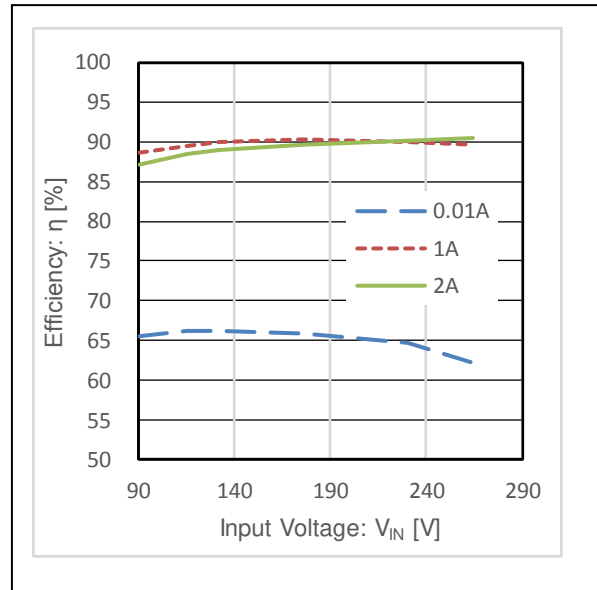

Figure 16. Line Regulation (Efficiency vs  $V_{IN}$ )

Measurement Data - continued

2 Line Regulation

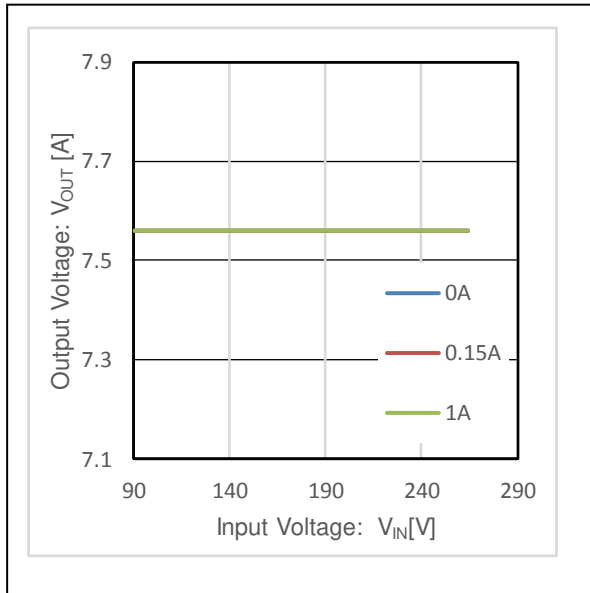

Figure 17. Line Regulation ( $V_{OUT}$  vs  $V_{IN}$ )

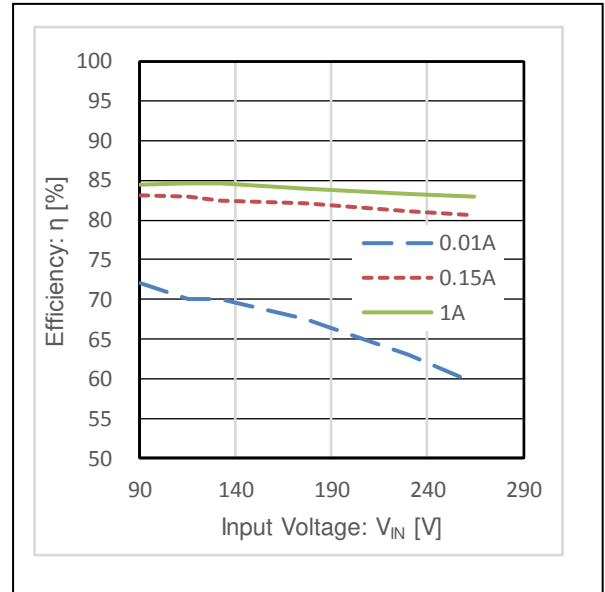

Figure 18. Line Regulation (Efficiency vs  $V_{IN}$ )

3 Switching Frequency

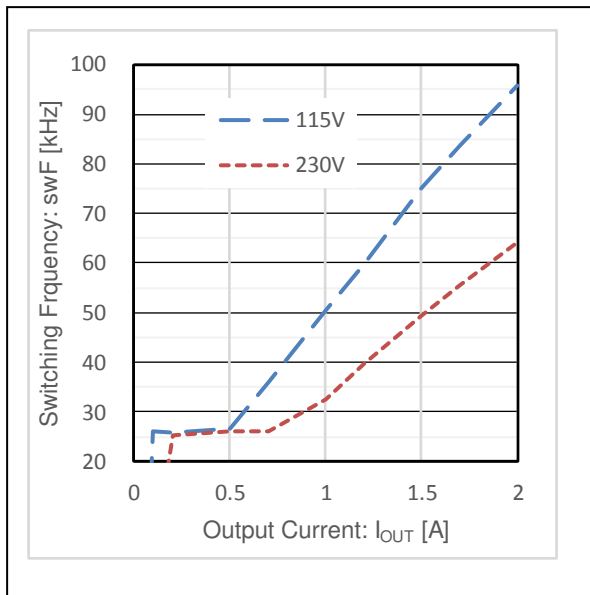

Figure 19. Switching Frequency (swF vs  $I_{OUT}$ )

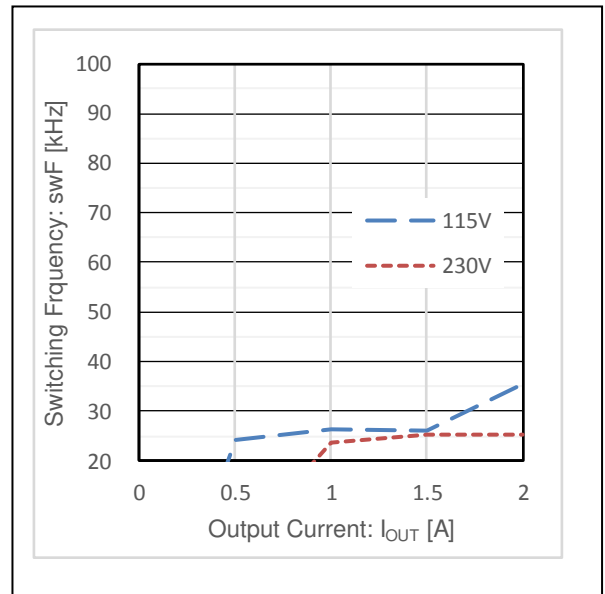

Figure 20. Switching Frequency (swF vs  $I_{OUT}$ )

Measurement Data - continued

4 Switching Wave Form

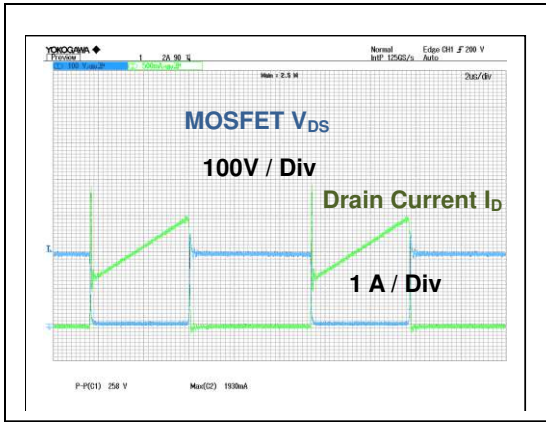

Figure 21. MOSFET Wave Form ( $V_{IN} = 90 \text{ Vac}$ ,  $I_{OUT} = 2 \text{ A}$ )

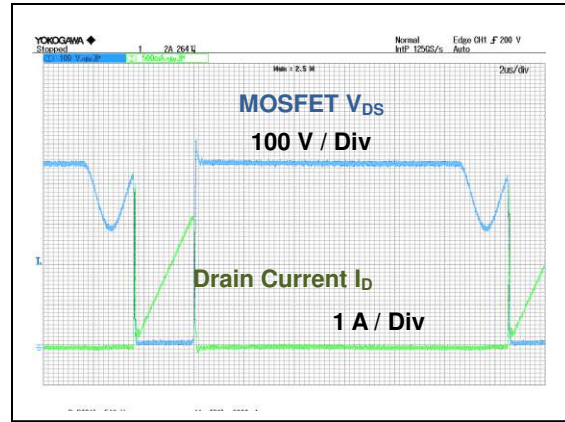

Figure 22. MOSFET Wave Form ( $V_{IN} = 264 \text{ Vac}$ ,  $I_{OUT} = 2 \text{ A}$ )

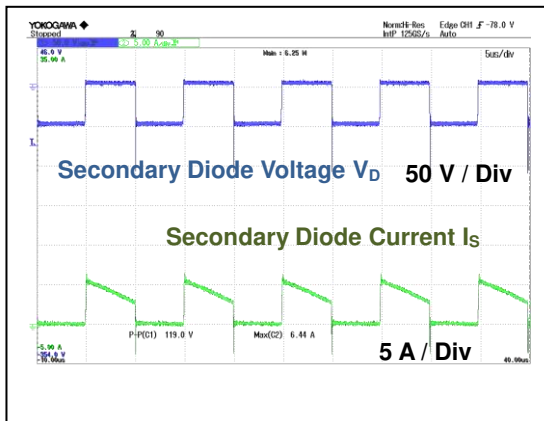

Figure 23. Diode Wave Form ( $V_{IN} = 90 \text{ Vac}$ ,  $I_{OUT} = 2 \text{ A}$ )

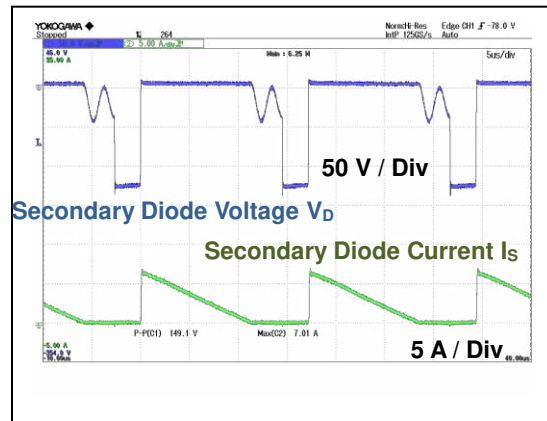

Figure 24. Diode Wave Form ( $V_{IN} = 264 \text{ Vac}$ ,  $I_{OUT} = 2 \text{ A}$ )



Measurement Data - continued

4 Switching Wave Form - continued

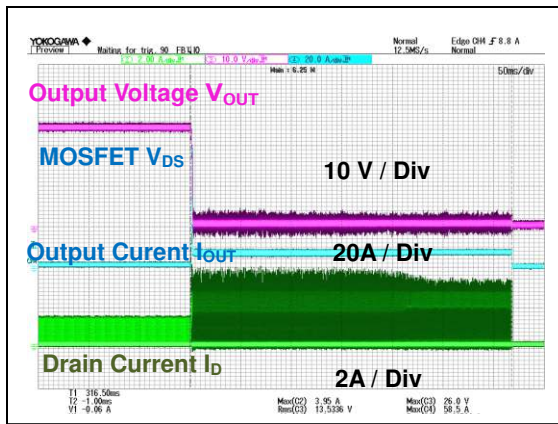

Figure 25. MOSFET Wave Form  
 $V_{IN} = 90 \text{ Vac}$ , Output Shorted

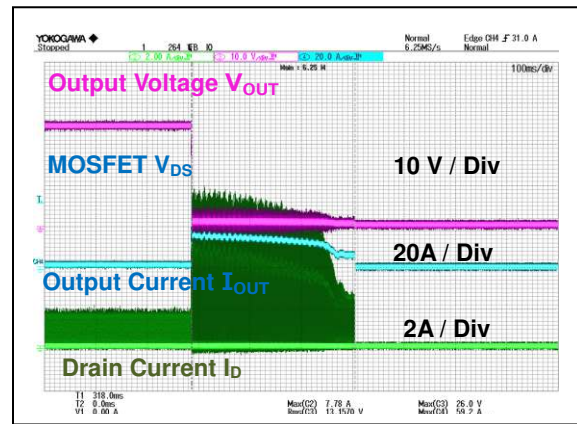

Figure 26. MOSFET Wave Form  
 $V_{IN} = 264 \text{ Vac}$ , Output Shorted

5 Startup Wave Form

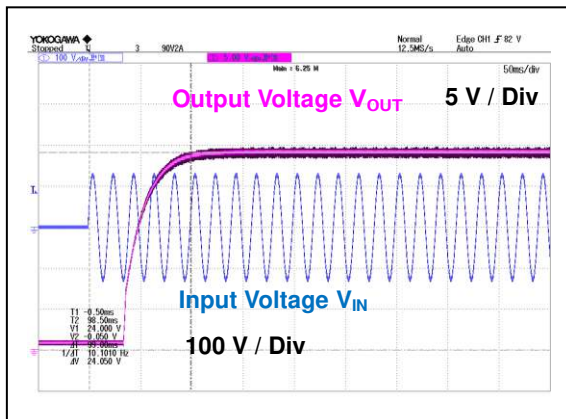

Figure 27.  $V_{IN} = 90 \text{ Vac}$ ,  $I_{OUT} = 2 \text{ A}$

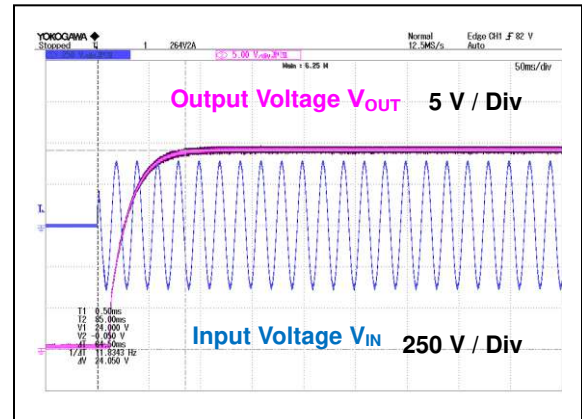

Figure 28.  $V_{IN} = 264 \text{ Vac}$ ,  $I_{OUT} = 2 \text{ A}$

Measurement Data - continued

6 Dynamic Load Fluctuation

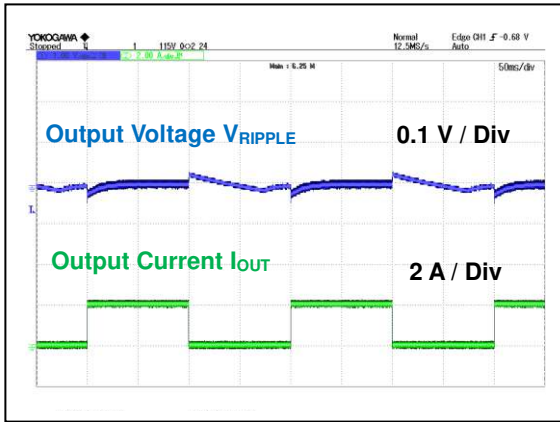

Figure 29.  $V_{IN} = 115 \text{ Vac}$ ,  $I_{OUT} = \text{switch } 0 \text{ A} / 2 \text{ A}$

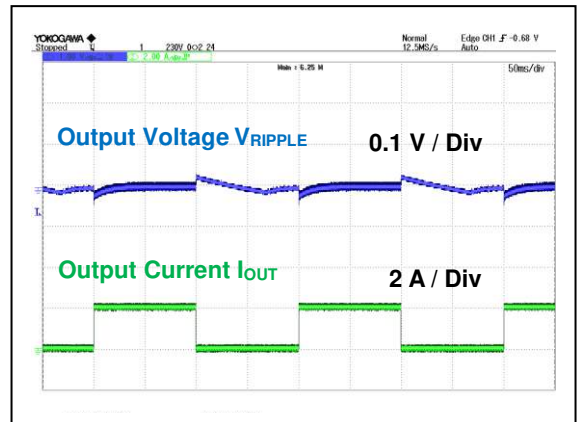

Figure 30.  $V_{IN} = 230 \text{ Vac}$ ,  $I_{OUT} = \text{switch } 0 \text{ A} / 2 \text{ A}$

7 Output Voltage Ripple Wave Form

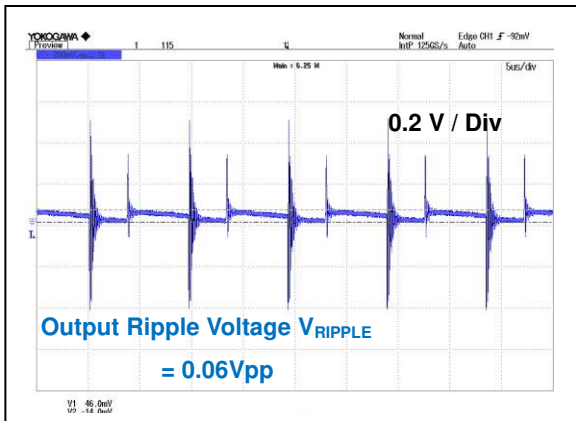

Figure 31.  $V_{IN} = 115 \text{ Vac}$ ,  $I_{OUT} = 2 \text{ A}$

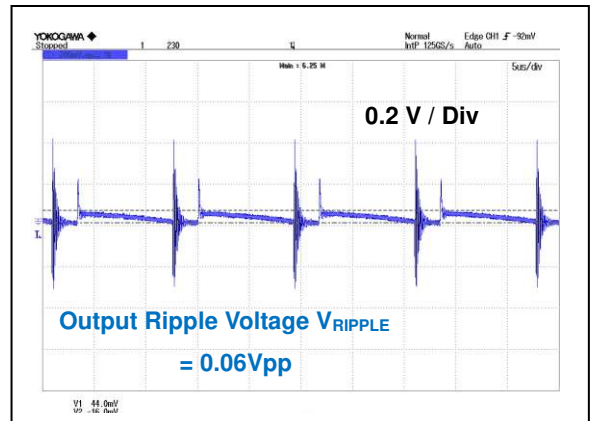

Figure 32.  $V_{IN} = 230 \text{ Vac}$ ,  $I_{OUT} = 2 \text{ A}$

8 Temperature of Parts Surface

They are measured after 15 minutes from applying a power supply.

Table 2. Surface Temperature of Parts ( $T_a = 25 \text{ }^\circ\text{C}$ )

Part	Condition	
	$V_{IN} = 90 \text{ Vac}$ , $I_{OUT} = 2 \text{ A}$	$V_{IN} = 264 \text{ Vac}$ , $I_{OUT} = 0.5 \text{ A}$
MOSFET Q1	71.8 $^\circ\text{C}$	63.5 $^\circ\text{C}$

Measurement Data – continued

9 EMI

9.1 Conducted Emission : CISPR22 Pub 22 Class B

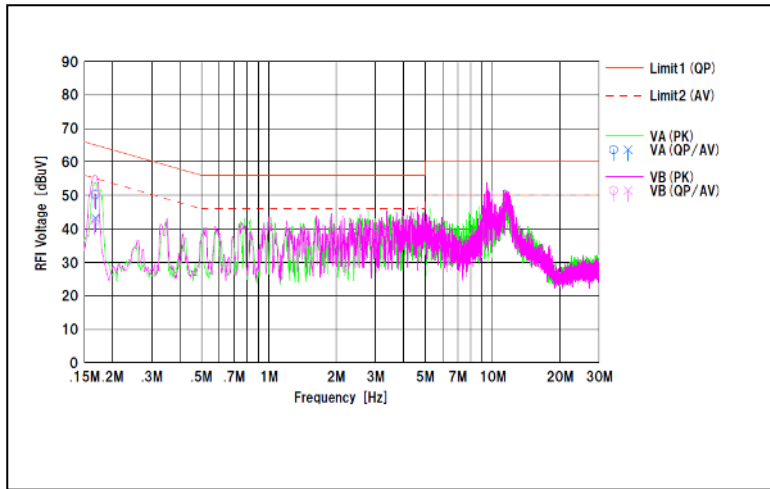

QP margin : 17.3 dB  
AVE margin : 18.5 dB

Figure 33.  $V_{IN}$ : 115 Vac / 60 Hz,  $I_{OUT}$ : 2 A

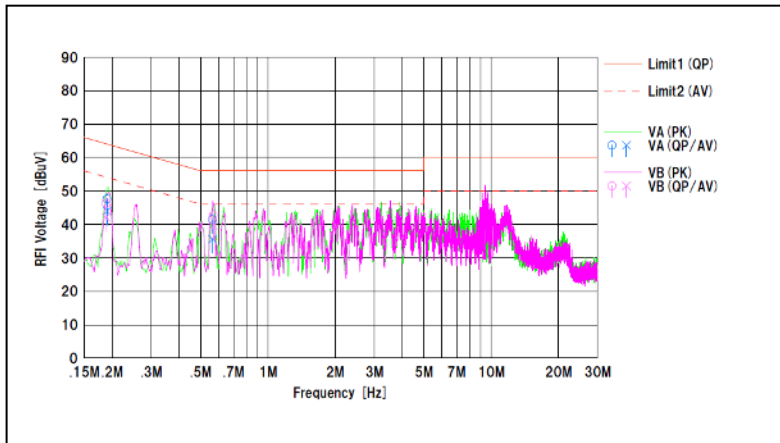

QP margin : 10.9 dB  
AVE margin : 5.5 dB

Figure 34.  $V_{IN}$ : 230 Vac / 50 Hz,  $I_{OUT}$ : 2 A

**Revision History**

Date	Rev.	Changes
24.August.2020	001	New Release

## Notes

- 1) The information contained herein is subject to change without notice.
- 2) Before you use our Products, please contact our sales representative and verify the latest specifications :
- 3) Although ROHM is continuously working to improve product reliability and quality, semiconductors can break down and malfunction due to various factors.  
Therefore, in order to prevent personal injury or fire arising from failure, please take safety measures such as complying with the derating characteristics, implementing redundant and fire prevention designs, and utilizing backups and fail-safe procedures. ROHM shall have no responsibility for any damages arising out of the use of our Products beyond the rating specified by ROHM.
- 4) Examples of application circuits, circuit constants and any other information contained herein are provided only to illustrate the standard usage and operations of the Products. The peripheral conditions must be taken into account when designing circuits for mass production.
- 5) The technical information specified herein is intended only to show the typical functions of and examples of application circuits for the Products. ROHM does not grant you, explicitly or implicitly, any license to use or exercise intellectual property or other rights held by ROHM or any other parties. ROHM shall have no responsibility whatsoever for any dispute arising out of the use of such technical information.
- 6) The Products specified in this document are not designed to be radiation tolerant.
- 7) For use of our Products in applications requiring a high degree of reliability (as exemplified below), please contact and consult with a ROHM representative : transportation equipment (i.e. cars, ships, trains), primary communication equipment, traffic lights, fire/crime prevention, safety equipment, medical systems, servers, solar cells, and power transmission systems.
- 8) Do not use our Products in applications requiring extremely high reliability, such as aerospace equipment, nuclear power control systems, and submarine repeaters.
- 9) ROHM shall have no responsibility for any damages or injury arising from non-compliance with the recommended usage conditions and specifications contained herein.
- 10) ROHM has used reasonable care to ensure the accuracy of the information contained in this document. However, ROHM does not warrants that such information is error-free, and ROHM shall have no responsibility for any damages arising from any inaccuracy or misprint of such information.
- 11) Please use the Products in accordance with any applicable environmental laws and regulations, such as the RoHS Directive. For more details, including RoHS compatibility, please contact a ROHM sales office. ROHM shall have no responsibility for any damages or losses resulting non-compliance with any applicable laws or regulations.
- 12) When providing our Products and technologies contained in this document to other countries, you must abide by the procedures and provisions stipulated in all applicable export laws and regulations, including without limitation the US Export Administration Regulations and the Foreign Exchange and Foreign Trade Act.
- 13) This document, in part or in whole, may not be reprinted or reproduced without prior consent of ROHM.



Thank you for your accessing to ROHM product informations.  
More detail product informations and catalogs are available, please contact us.

**ROHM Customer Support System**

<http://www.rohm.com/contact/>