

Multilayer Antenna (Triple Band type)

For 1574-1577MHz / 2400-2484MHz / 5150-5850MHz

ANT025020LCT1575MA1

2.5x2.0mm [EIA 1008]*

* Dimensions Code JIS[EIA]

Caution

**The products in this catalog will be or have been
stopped production**

Discontinue Issue Date	Apr. 28, 2021
Last Purchase Order Date	Dec. 31, 2022
Last Shipment Date	Mar. 31, 2023

Please refer to our Web site about replacement information.

Multilayer Antenna (Triple Band type)

Conformity to RoHS Directive

For 1574-1577MHz / 2400-2484MHz / 5150-5850MHz

ANT025020LCT1575MA1

SHAPES AND DIMENSIONS

[Top view]

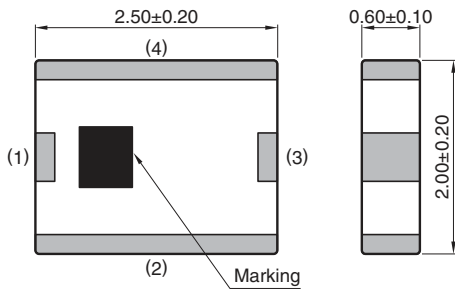

[Bottom view]

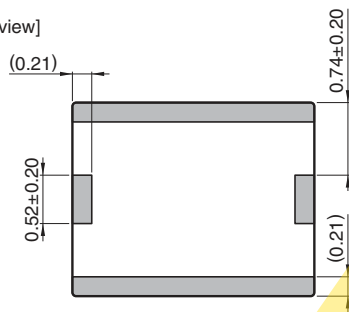

Terminal functions

- | | |
|---|-------------------------------|
| 1 | Radiator electrode for GPS |
| 2 | Radiator electrode for 5.5GHz |
| 3 | Feed point |
| 4 | Radiator electrode for 2.4GHz |

Dimensions in mm

RECOMMENDED LAND PATTERN

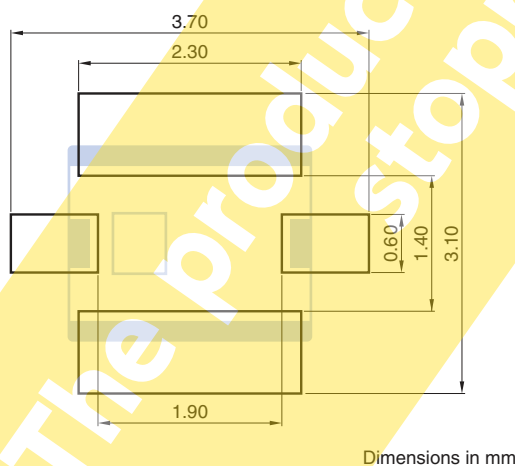

Dimensions in mm

SOLDER RESIST PATTERN

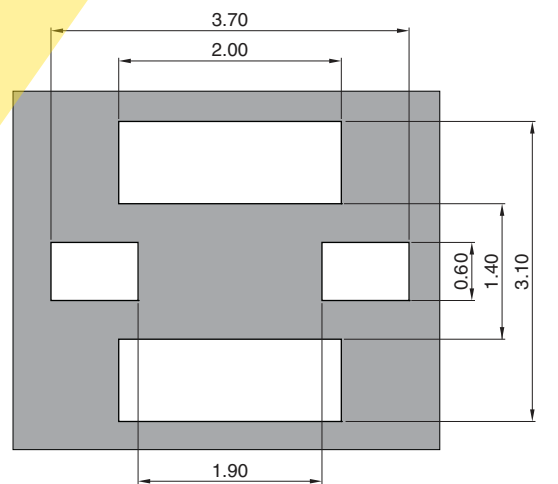

Dimensions in mm

RoHS Directive Compliant Product: See the following for more details. <https://product.tdk.com/info/en/environment/rohs/index.html>

- All specifications are subject to change without notice.
- Before using these products, be sure to request the delivery specifications.

ANT025020LCT1575MA1

EVALUATION BOARD

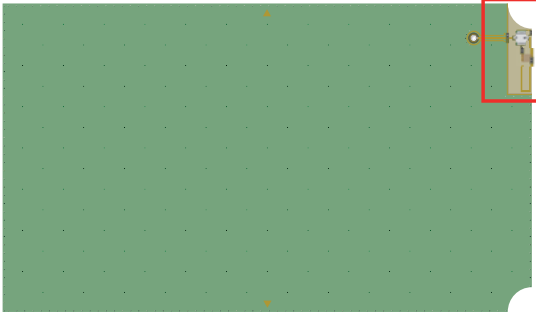

PCB size : 130mm x 75mm x 1mm
Antenna area : 16 x 6 mm

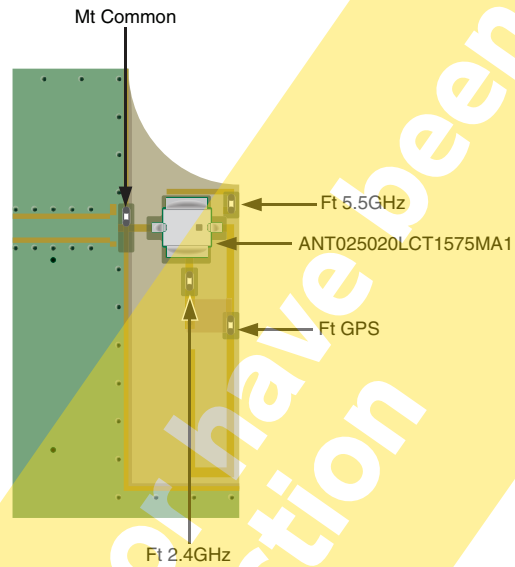

	Component P/N
Ft GPS	3.0nH
Ft 2.4GHz	1.6pF
Ft 5.5GHz	1.0nH
Mt Common	2.7nH

Measurement condition for Radiation Pattern

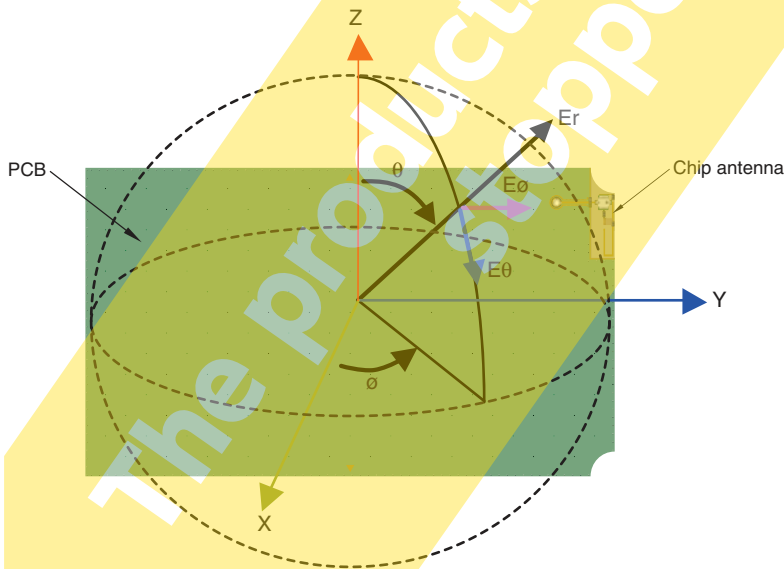

- All specifications are subject to change without notice.
- Before using these products, be sure to request the delivery specifications.

ANT025020LCT1575MA1

ELECTRICAL CHARACTERISTICS

Item	Frequency Range (MHz)	Min.	Typ.	Max.
VSWR	1574 to 1577	—	1.30	4.0
	2400 to 2484	—	1.80	4.0
	5150 to 5850	—	2.40	4.0
Polarization			Linear	
PCB size (mm)			130 x 75	
Antenna keep-out area (mm)			16 x 6	
Characteristic Impedance (Ω)			50 (Nominal)	

• This is typical antenna performance with the standard PCB.

TEMPERATURE RANGE

Operating temperature (°C)	Storage temperature (°C)
-40 to +85	-40 to +85

FREQUENCY CHARACTERISTICS

GPS BAND

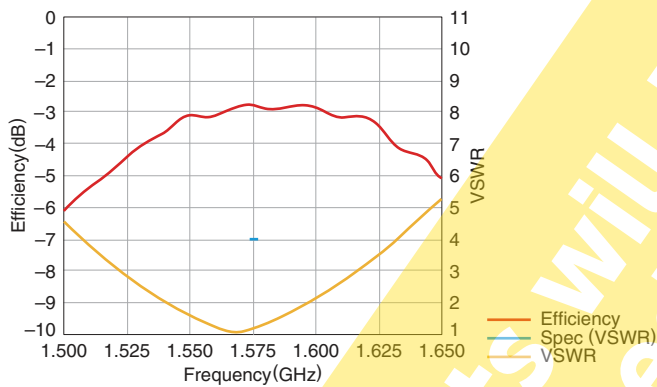

2.4GHz BAND

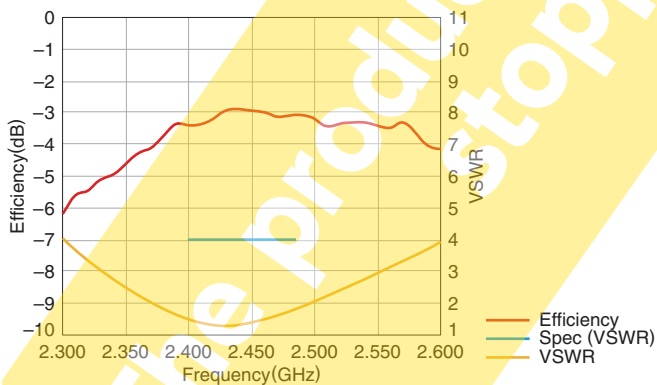

5.5GHz BAND

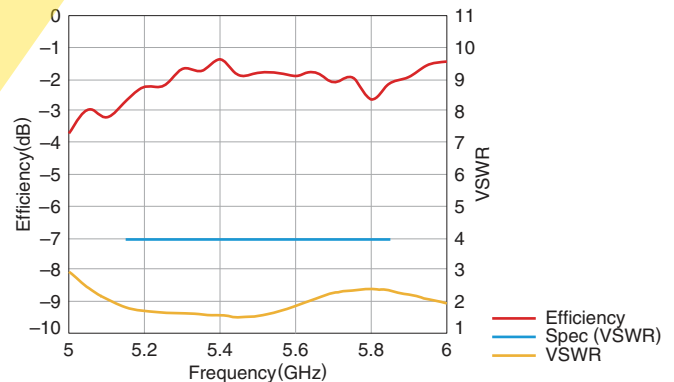

• Tested antenna has been soldered. Evaluation board size is 130x75x1 mm.

- All specifications are subject to change without notice.
- Before using these products, be sure to request the delivery specifications.

ANT025020LCT1575MA1

RADIATION PATTERNS

GPS BAND

RHCP

Z-X plane

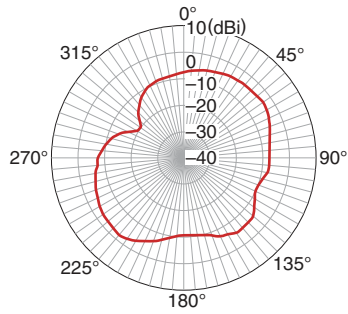

Frequency(GHz)	1.5755
Average(dBic)	-6.4
Maximum(dBic)	-1.7
Minimum(dBic)	-19.6

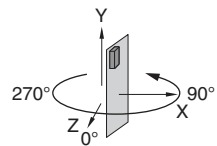

Z-Y plane

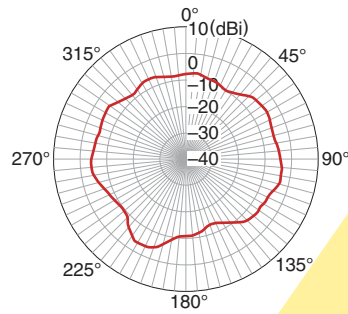

Frequency(GHz)	1.5755
Average(dBic)	-6.5
Maximum(dBic)	-3.3
Minimum(dBic)	-13.4

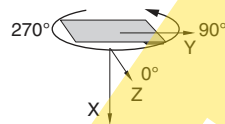

X-Y plane

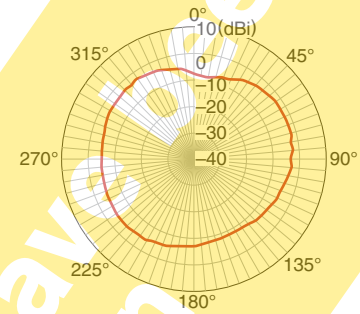

Frequency(GHz)	1.5755
Average(dBic)	-4.8
Maximum(dBic)	-2.7
Minimum(dBic)	-8.8

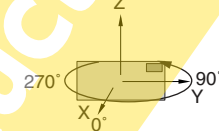

- Tested antenna has been soldered. Evaluation board size is 130x75x1 mm.

The products will be or have been stopped production

- All specifications are subject to change without notice.
- Before using these products, be sure to request the delivery specifications.

ANT025020LCT1575MA1

RADIATION PATTERNS

2.4GHz BAND

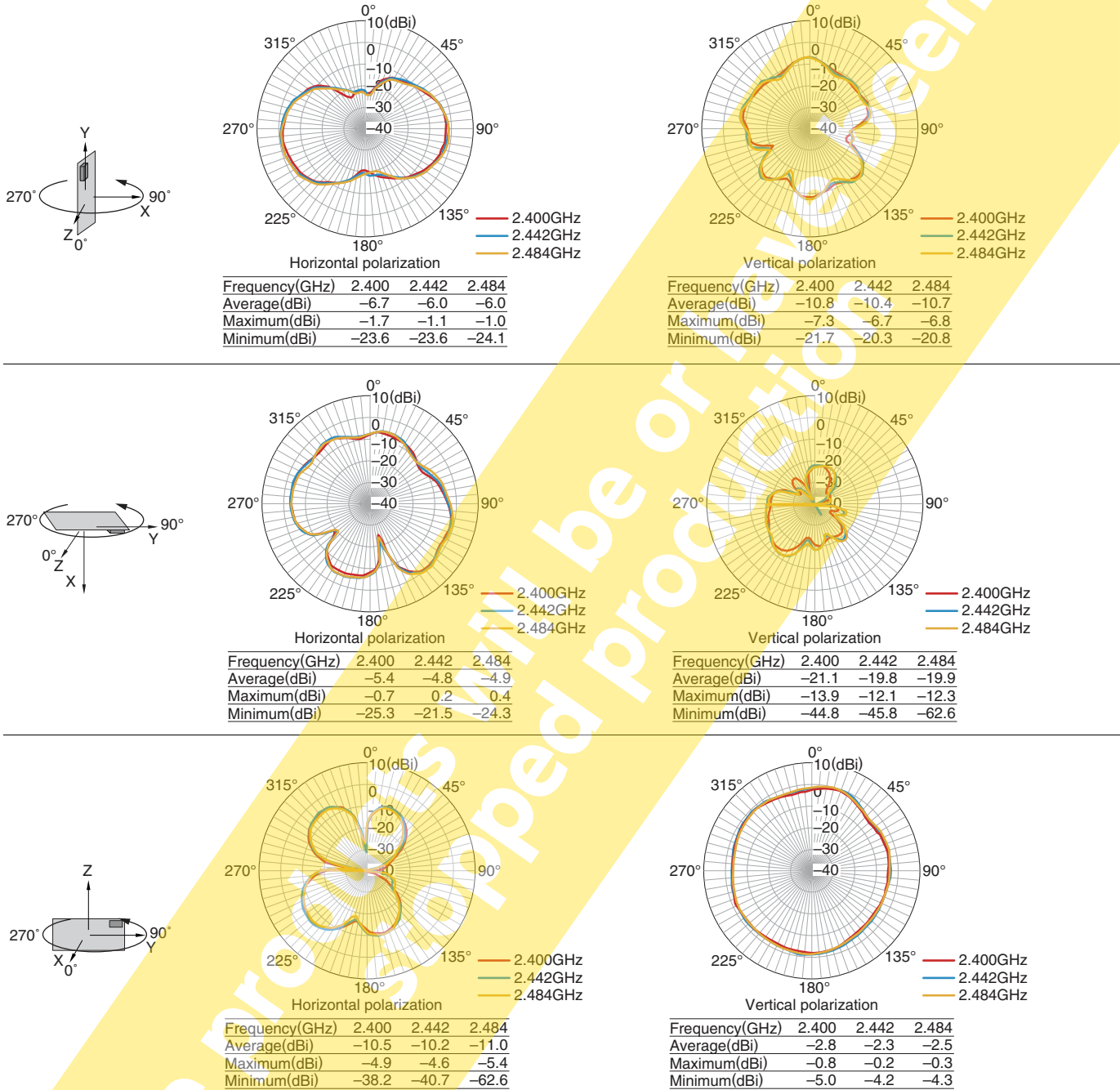

• Tested antenna has been soldered. Evaluation board size is 130x75x1 mm.

- All specifications are subject to change without notice.
- Before using these products, be sure to request the delivery specifications.

ANT025020LCT1575MA1

RADIATION PATTERNS

5.5GHz BAND

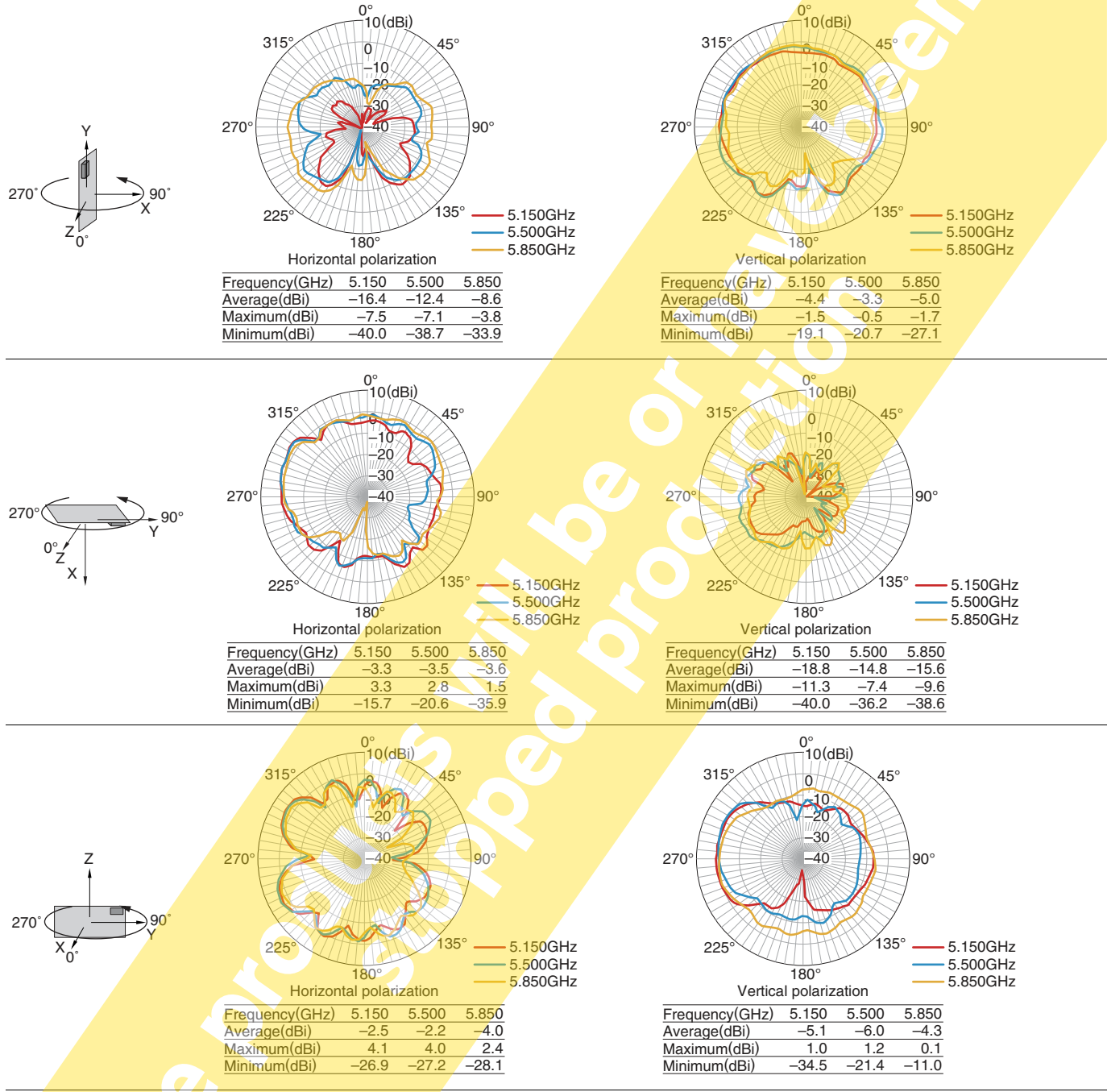

• Tested antenna has been soldered. Evaluation board size is 130x75x1 mm.

- All specifications are subject to change without notice.
- Before using these products, be sure to request the delivery specifications.

RECOMMENDED REFLOW PROFILE

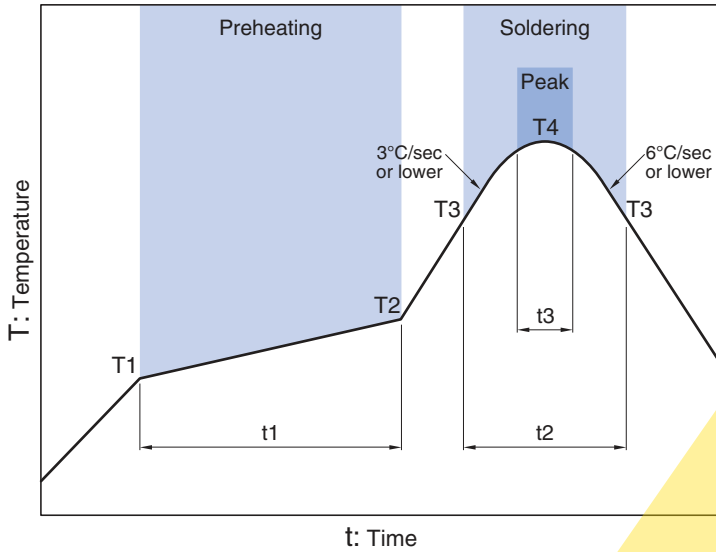

Preheating			Soldering			
			Critical zone (T3 to T4)		Peak	
Temp.		Time	Temp.	Time	Temp.	Time
T1	T2	t1	T3	t2	T4	t3*
150°C	200°C	60 to 120sec	217°C	60 to 120sec	240 to 260°C	30sec max.

* t3 : Time within 5°C of actual peak temperature
 The maximum number of reflow is 3.

The products will be or have been stopped production

ANT025020LCT1575MA1

PACKAGING STYLE

REEL DIMENSIONS

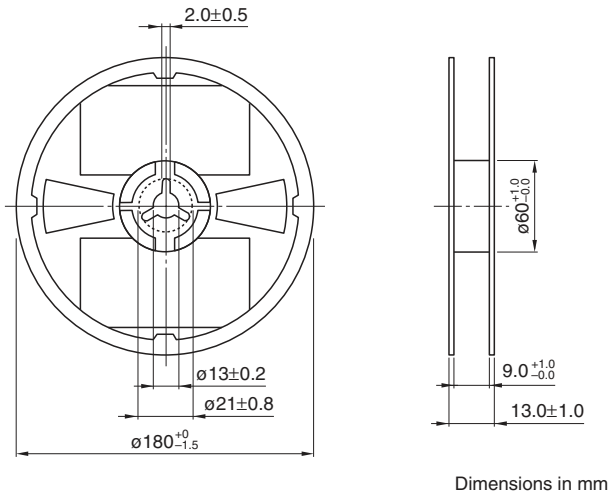

TAPE DIMENSIONS

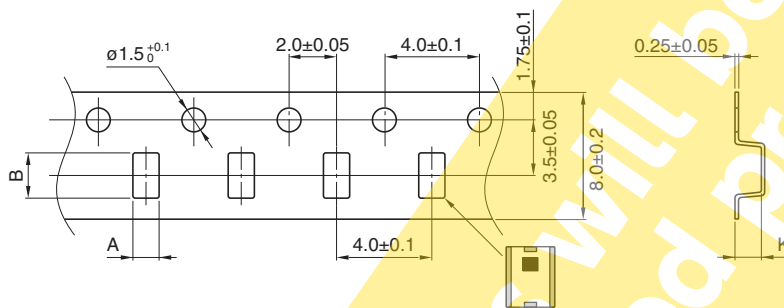

A	B	K
2.35±0.05	2.85±0.05	0.90±0.05

PACKAGE QUANTITY

Standard package quantity
(pieces/reel)

2,000

- All specifications are subject to change without notice.
- Before using these products, be sure to request the delivery specifications.

REMINDERS FOR USING THESE PRODUCTS

Before using these products, be sure to request the delivery specifications.

SAFETY REMINDERS

Please pay sufficient attention to the warnings for safe designing when using these products.

REMINDERS

The products listed on this catalog are intended for use in general electronic equipment (AV equipment, telecommunications equipment, home appliances, amusement equipment, computer equipment, personal equipment, office equipment, measurement equipment, industrial robots) under a normal operation and use condition.

The products are not designed or warranted to meet the requirements of the applications listed below, whose performance and/or quality require a more stringent level of safety or reliability, or whose failure, malfunction or trouble could cause serious damage to society, person or property.

Please understand that we are not responsible for any damage or liability caused by use of the products in any of the applications below or for any other use exceeding the range or conditions set forth in this catalog.

- | | |
|---|--|
| (1) Aerospace/Aviation equipment | (8) Public information-processing equipment |
| (2) Transportation equipment (cars, electric trains, ships, etc.) | (9) Military equipment |
| (3) Medical equipment | (10) Electric heating apparatus, burning equipment |
| (4) Power-generation control equipment | (11) Disaster prevention/crime prevention equipment |
| (5) Atomic energy-related equipment | (12) Safety equipment |
| (6) Seabed equipment | (13) Other applications that are not considered general-purpose applications |
| (7) Transportation control equipment | |

When using this product in general-purpose applications, you are kindly requested to take into consideration securing protection circuit/equipment or providing backup circuits, etc., to ensure higher safety.