

## Ultra low capacitance single line ESD protection

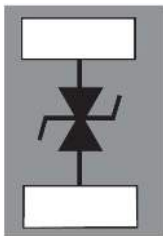

0201 package



### Features

- +/- 20V  $V_{RM}$
- Low  $V_{BR}/V_{CL}$  ratio
- Bidirectional protection
- Low leakage current < 1 nA typ.
- Ultra low PCB area: 0.18 mm<sup>2</sup>
- 0201 package
- ECOPACK2 compliant component
- Exceeds IEC 61000-4-2 level 4 standard:
  - ±30 kV (air discharge)
  - ±20 kV (contact discharge)

### Application

Where transient over voltage protection in ESD sensitive equipment is required, such as:

- Smartphones, mobile phones and accessories
- Tablets and notebooks
- Portable multimedia devices and accessories
- Digital cameras and camcorders
- Communication and highly integrated systems

#### Product status

Internal

### Description

The ESDALC20-1BF4 is a bidirectional single line TVS diode designed to protect the data line or other I/O ports against ESD transients.

The device is ideal for applications where both reduced line capacitance and board space saving are required.

# 1 Characteristics

**Table 1. Absolute maximum ratings ( $T_{amb} = 25\text{ }^{\circ}\text{C}$ )**

Symbol	Parameter		Value	Unit
$V_{pp}$	Peak pulse voltage	IEC 61000-4-2 contact discharge	$\pm 20$	kV
		IEC 61000-4-2 air discharge	$\pm 30$	
$P_{pp}$	Peak pulse power (8/20 $\mu\text{s}$ )		90	W
$I_{pp}$	Peak pulse current (8/20 $\mu\text{s}$ )		2.4	A
$T_j$	Operating junction temperature range		-40 to 150	$^{\circ}\text{C}$
$T_{stg}$	Storage junction temperature range		-65 to 150	
$T_L$	Maximum lead temperature for soldering during 10 s		260	

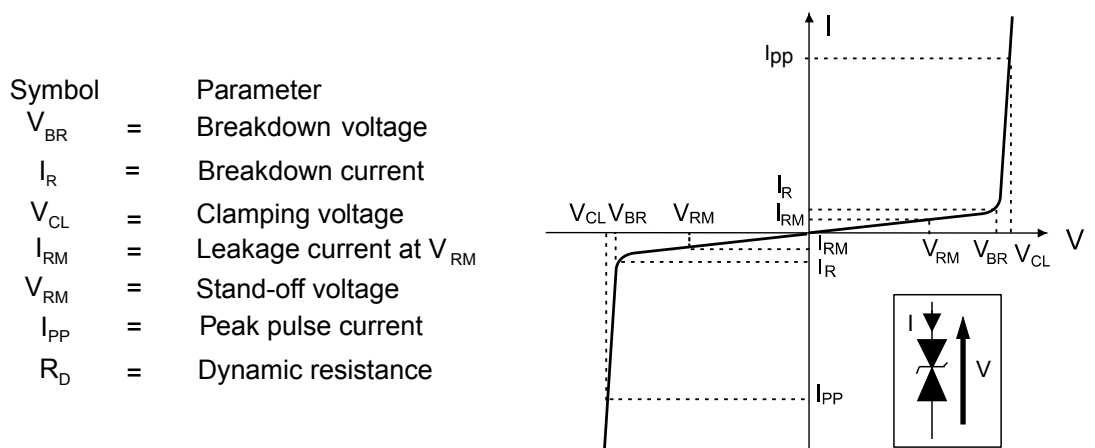
**Figure 1. Electrical characteristics (definitions)**

**Table 2. Electrical characteristics (values) ( $T_{amb} = 25\text{ }^{\circ}\text{C}$ )**

Symbol	Parameter	Test condition	Min.	Typ.	Max.	Unit
$V_{RM}$	Stand-off voltage		-20		20	V
$V_{BR}$	Breakdown voltage	$I_R = 1\text{ mA}$	22	23		V
$I_{RM}$	Leakage current	$V_{RM} = 20\text{ V}$		< 1	10	nA
$V_{CL}$	Reverse clamping voltage	8 kV contact discharge after 30 ns, IEC 61000-4-2		37		V
$C_{LINE}$	Line capacitance	$V_{LINE} = 0\text{ V}$ , $F = 1\text{ MHz}$ , $V_{OSC} = 30\text{ mV}$		10.5	11.5	pF

## 1.1 Characteristics (curves)

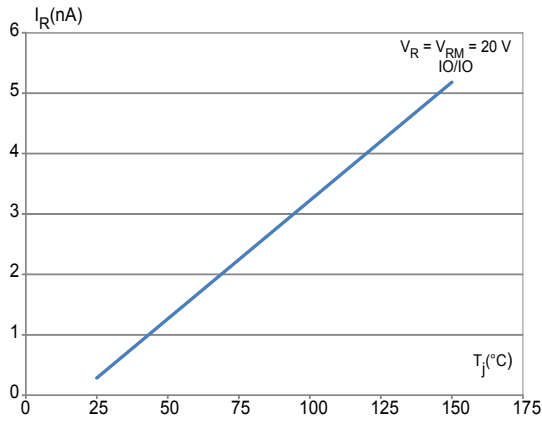
**Figure 2. Leakage current versus junction temperature (typical values)**



**Figure 3. Junction capacitance versus frequency (typical values)**

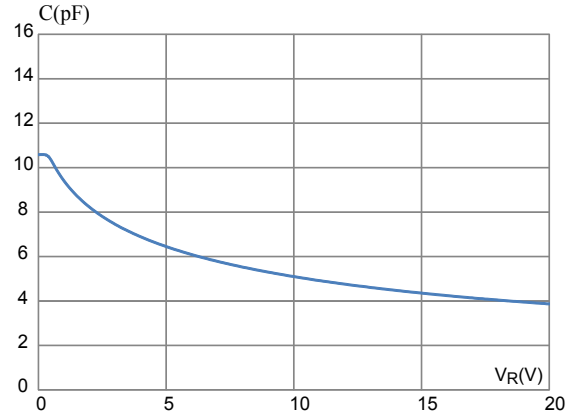

**Figure 4. ESD response to IEC 61000-4-2 (+8 kV contact discharge)**

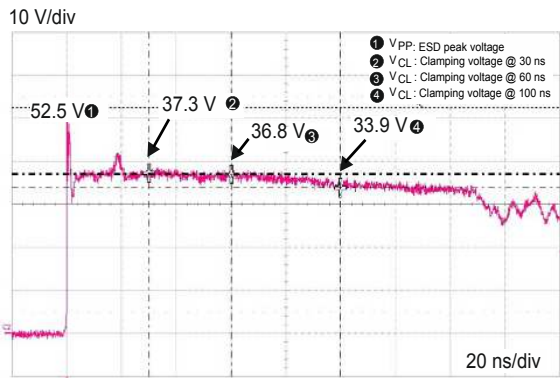

**Figure 5. ESD response to IEC 61000-4-2 (-8 kV contact discharge)**

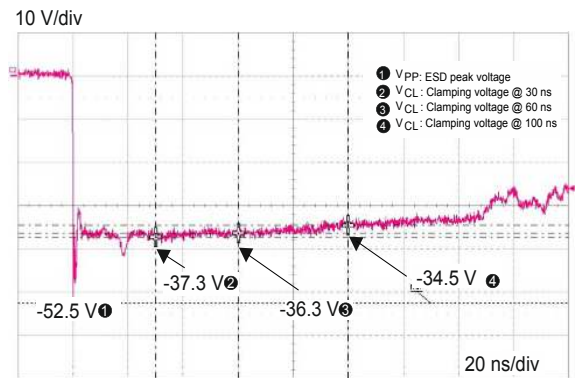

**Figure 6. S21 attenuation measurement result**

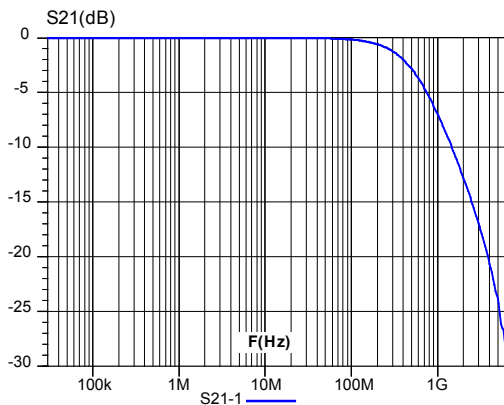

**Figure 7. TLP measurement**

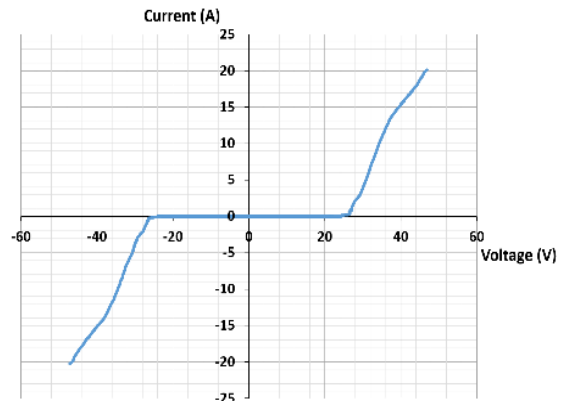

## 2 Package information

In order to meet environmental requirements, ST offers these devices in different grades of **ECOPACK** packages, depending on their level of environmental compliance. ECOPACK specifications, grade definitions and product status are available at: [www.st.com](http://www.st.com). ECOPACK is an ST trademark.

### 2.1 0201 package information

**Figure 8. ST0201 package outline**

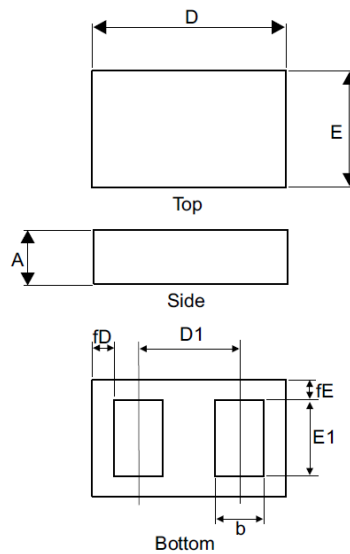
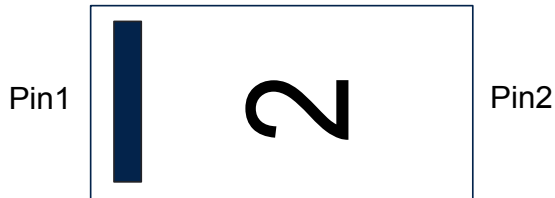

**Table 3. ST0201 package mechanical data**

Ref.	Dimensions					
	Millimeters			Inches		
	Min.	Typ.	Max.	Min.	Typ.	Max.
A	0.280	0.300	0.320	0.0110	0.0118	0.0126
b	0.125	0.140	0.155	0.0049	0.0055	0.0061
D	0.570	0.600	0.630	0.0224	0.0236	0.0248
D1		0.350			0.0138	
E	0.270	0.300	0.330	0.0106	0.0118	0.0130
E1	0.175	0.190	0.205	0.0069	0.0075	0.0081
fD	0.040	0.055	0.070	0.0015	0.0021	0.0028
fE	0.040	0.055	0.070	0.0115	0.0021	0.0028

## 2.2 Packing and marking information

**Figure 9. Marking layout**



The marking «2» can be rotated by a multiple of 90° to differentiate assembly location

**Figure 10. Package orientation in reel**

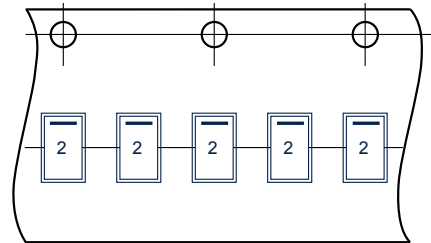

Taped according to EIA-481

Note: Pocket dimensions are not on scale  
Pocket shape may vary depending on package  
On bidirectional devices, marking and logo may be not always in the same direction

**Figure 11. Tape outline**

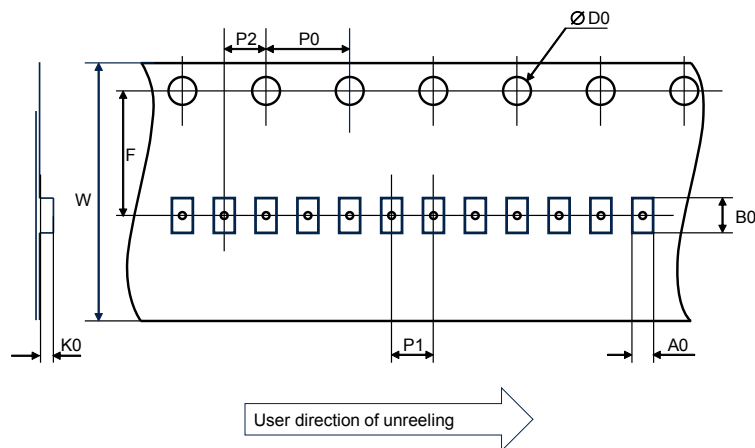

**Table 4. Tape and reel mechanical data**

Ref.	Dimensions		
	Millimeters		
	Min.	Typ.	Max.
A0	0.31	0.34	0.37
B0	0.61	0.64	0.67
D0	1.40	1.50	1.60
F	3.45	3.50	3.55
K0	0.31	0.34	0.37
P0	3.90	4.00	4.10
P1	1.95	2.00	2.05
P2	1.95	2.00	2.05
W	7.90	8.00	8.30

### 3 Recommendation on PCB assembly

#### 3.1 Footprint

Figure 12. Recommended footprint in mm

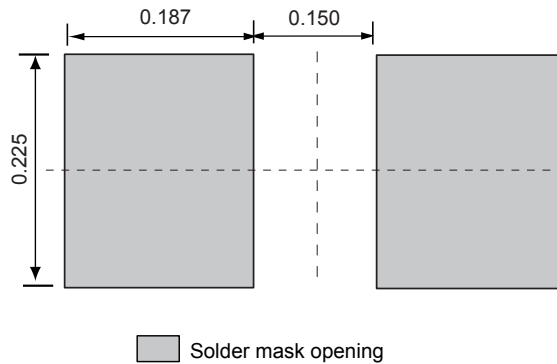

#### 3.2 Stencil opening design

Stencil opening thickness: 75  $\mu\text{m}$  / 3 mils

Figure 13. Stencil opening recommendations

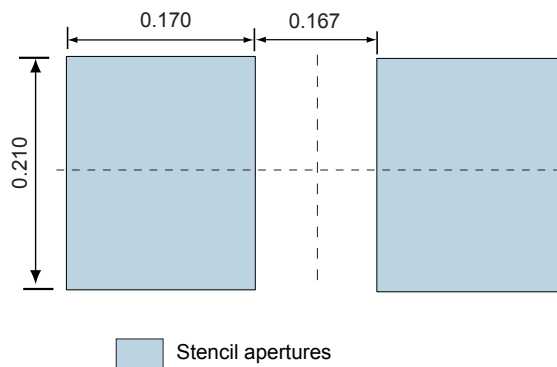

### 3.3 Solder paste

1. Halide-free flux qualification ROL0 according to ANSI/J-STD-004.
2. “No clean” solder paste is recommended.
3. Offers a high tack force to resist component movement during high speed.
4. Use solder paste with fine particles: powder particle size 20-38  $\mu\text{m}$ .

### 3.4 Placement

1. Manual positioning is not recommended.
2. It is recommended to use the lead recognition capabilities of the placement system, not the outline centering
3. Standard tolerance of  $\pm 0.05$  mm is recommended.
4. 1.0 N placement force is recommended. Too much placement force can lead to squeezed out solder paste and cause solder joints to short. Too low placement force can lead to insufficient contact between package and solder paste that could cause open solder joints or badly centered packages.
5. To improve the package placement accuracy, a bottom side optical control should be performed with a high resolution tool.
6. For assembly, a perfect supporting of the PCB (all the more on flexible PCB) is recommended during solder paste printing, pick and place and reflow soldering by using optimized tools.

### 3.5 PCB design preference

1. To control the solder paste amount, the closed via is recommended instead of open vias.
2. The position of tracks and open vias in the solder area should be well balanced. A symmetrical layout is recommended, to avoid any tilt phenomena caused by asymmetrical solder paste due to solder flow away.

### 3.6 Reflow profile

**Figure 14. ST ECOPACK recommended soldering reflow profile for PCB mounting**

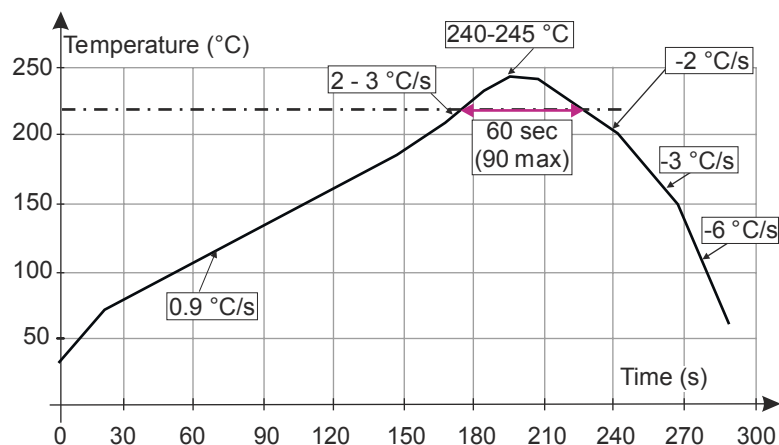

**Note:** Minimize air convection currents in the reflow oven to avoid component movement. Maximum soldering profile corresponds to the latest IPC/JEDEC J-STD-020.

## 4 Ordering information

Figure 15. Ordering information scheme

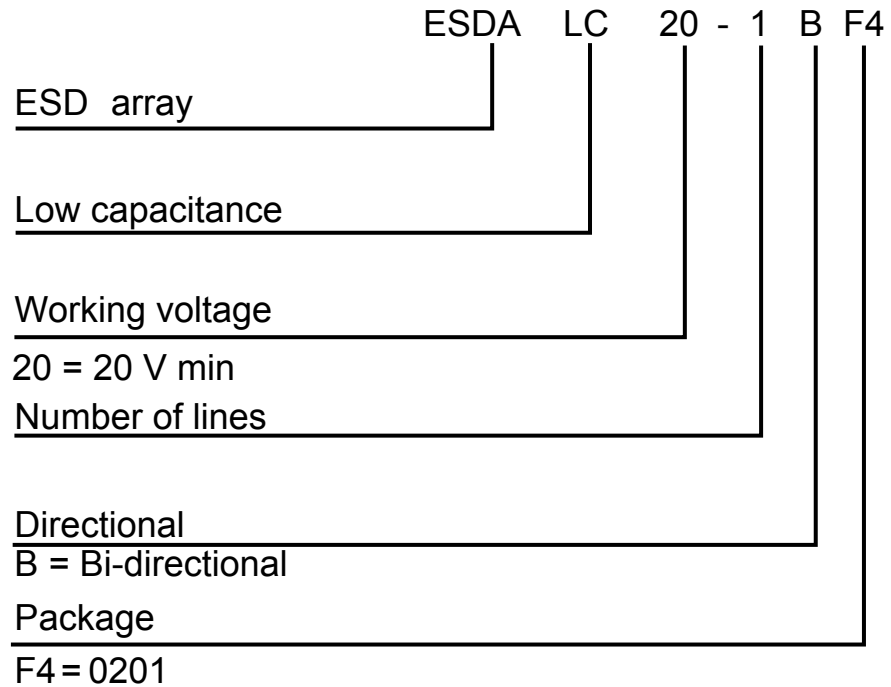

Table 5. Ordering information

Order code	Marking	Package	Weight	Base qty.	Delivery mode
ESDALC20-1BF4	2 <sup>(1)</sup>	ST0201	0.116 mg	15000	Tape and reel

1. The marking can be rotated by multiples of 90° to differentiate assembly location



## Revision history

**Table 6. Document revision history**

Date	Revision	Changes
23-Jul-2015	1	First issue.
01-Aug-2016	2	Updated Table 3.
29-Jun-2022	3	Updated <a href="#">Figure 7</a> , <a href="#">Section 2.1</a> , <a href="#">Section 2.2</a> and <a href="#">Section 3.1</a> . Minor text changes.

**IMPORTANT NOTICE – READ CAREFULLY**

STMicroelectronics NV and its subsidiaries (“ST”) reserve the right to make changes, corrections, enhancements, modifications, and improvements to ST products and/or to this document at any time without notice. Purchasers should obtain the latest relevant information on ST products before placing orders. ST products are sold pursuant to ST’s terms and conditions of sale in place at the time of order acknowledgment.

Purchasers are solely responsible for the choice, selection, and use of ST products and ST assumes no liability for application assistance or the design of purchasers’ products.

No license, express or implied, to any intellectual property right is granted by ST herein.

Resale of ST products with provisions different from the information set forth herein shall void any warranty granted by ST for such product.

ST and the ST logo are trademarks of ST. For additional information about ST trademarks, refer to [www.st.com/trademarks](http://www.st.com/trademarks). All other product or service names are the property of their respective owners.

Information in this document supersedes and replaces information previously supplied in any prior versions of this document.

© 2022 STMicroelectronics – All rights reserved