

Features

- Super Heterodyne Radio Receiver
- High Sensitivity -106dBm
- CMOS / TTL Output
- Stable Operating Frequency
- Low Current Consumption
- 3-5Vdc Operating Voltage
- ASK Demodulation
- Available as 315 or 433 MHz



Applications

- Wireless Security Systems
- Garage Door controller
- Remote Gate Controls
- Remote Sensing
- Data Capture
- Sensor Reporting

Description

The Quasar UK AM receiver module provides a complete Radio receiver which can be used to receive undecoded data from the range of Quasar (UK) transmitter modules.

The module is very simple to operate and offers a low current consumption, allowing for extended battery life when used in mobile applications.

Data can be fed directly into a microprocessor or decoding device, thus keeping the component count down and ensuring a low hardware cost.

All receivers are compatible, producing a CMOS/TTL output, and only require connections to power and antenna.

Part Numbers

Part Number	Description
QAM-RX5-433	AM Super Regen Receiver Module, 433MHz
QAM-RX5-315	AM Super Regen Receiver Module, 315MHz

Technical Specifications

Pin Descriptions

Pin	Description
1	External Antenna
2, 3, 8	Ground
6, 7	Data input
4,5	Supply Voltage

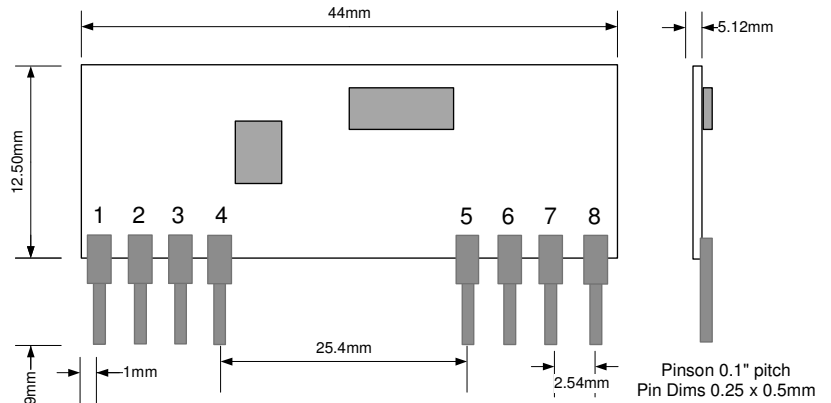

Electrical Characteristics

Ambient temp = 25°C unless otherwise stated. Vcc=5V 1KB/s AM99% Square Wave Modulation

Characteristic	Min.	Typ.	Max.	Dimensions
Supply Voltage	2.5	5	5.5	Vdc
Supply Current		4.7		mA
RF Sensitivity		-106		dBm
Working Frequency		315 / 433.92		MHz
High Level Output	0.7Vcc			Vdc
Low Level Output			0.3Vcc	Vdc
Turn On Time		25		Ms
Data Rate	200	1,000	3,000	Hz
Bandwidth		800		KHz

Typical Application

For further information on this circuit please refer to the RF Solutions datasheet DS600

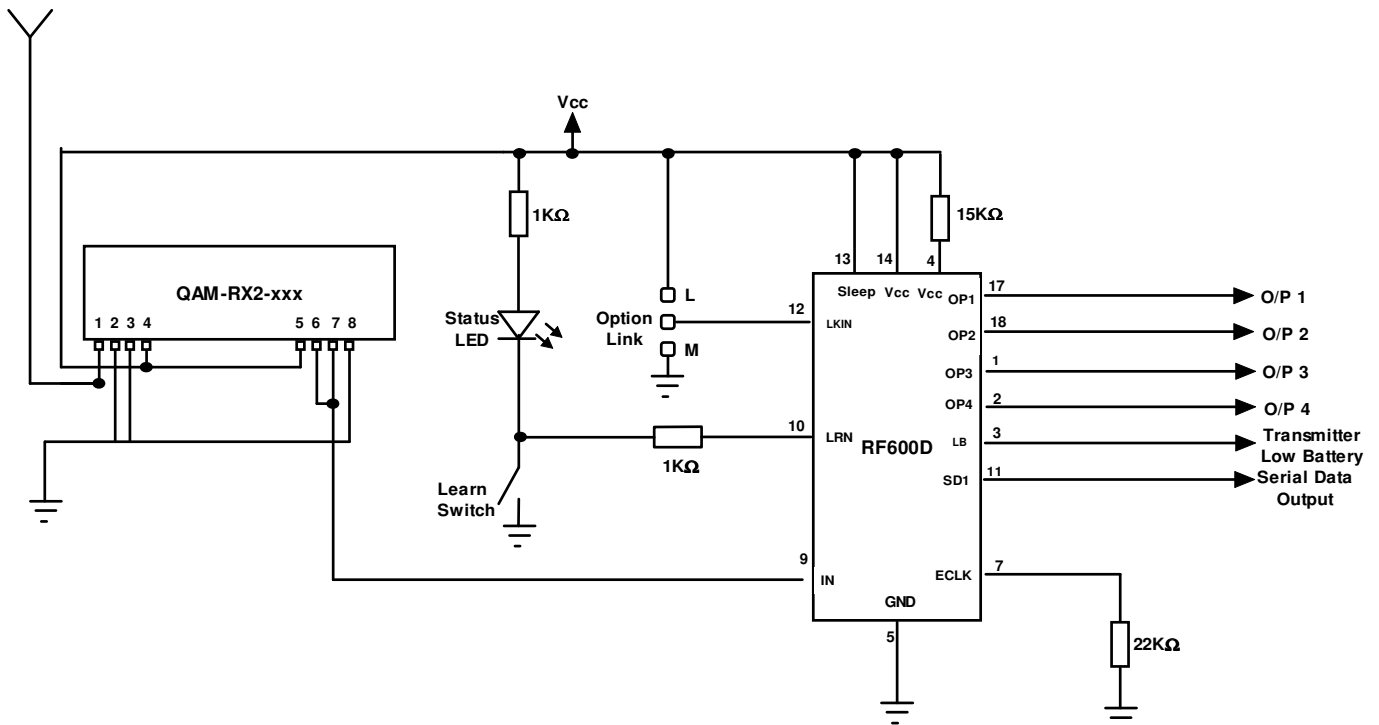

Information contained in this document is believed to be accurate, however no representation or warranty is given and no liability is assumed by Quasar (UK) Ltd. with respect to the accuracy of such information. Use of products as critical components in life support systems is not authorised except with express written approval from Quasar (UK) Ltd.



QuasarUK is an internet based company. All Sales / support and interface is via our website at

www.quasaruk.co.uk

for Sales:

Sales : sales@quasaruk.co.uk

for Support:

Support : sales@quasaruk.co.uk

Support Tel: 0907 639 0000

Calls charged at £0.60 per minute from a BT landline other networks may vary. Callers must be 18 or over and have the bill payers permission. Service provided by StealthNET Ltd :08444150774

Disclaimer:

Whilst the information in this document is believed to be correct at the time of issue, QuasarUK Ltd does not accept any liability whatsoever for its accuracy, adequacy or completeness. No express or implied warranty or representation is given relating to the information contained in this document. QuasarUK Ltd reserves the right to make changes and improvements to the product(s) described herein without notice. Buyers and other users should determine for themselves the suitability of any such information or products for their own particular requirements or specification(s). QuasarUK Ltd shall not be liable for any loss or damage caused as a result of user's own determination of how to deploy or use R F Solutions Ltd's products. Use of QuasarUK Ltd products or components in life support and/or safety applications is not authorised except with express written approval. No licences are created, implicitly or otherwise, under any of QuasarUK Ltd's intellectual property rights. Liability for loss or damage resulting or caused by reliance on the information contained herein or from the use of the product (including liability resulting from negligence or where QuasarUK Ltd was aware of the possibility of such loss or damage arising) is excluded. This will not operate to limit or restrict QuasarUK Ltd's liability for death or personal injury resulting from its negligence.