

QT-Brightek Lamp Series

5mm Round LED

Part No.: QBL8XX15C_series

XX: Color Code

Table of Contents:

Introduction	3
Electrical / Optical Characteristic (Ta=25 °C)	4
Absolute Maximum Rating	4
Characteristic Curves.....	5
Ordering Information	7
Revision History	8
Disclaimer	8

Introduction

Feature:

- Clear lens
- Package in bulk pack
- 5mm round lamp
- AllnGaP technology for R/Y/O/AG
- InGaN technology for IG/IB
- Viewing angle: 15° typ.

Description:

These bright 5mm round type lamps are suitable for all indicator applications such as electronic signs and electronics board indicator

Application:

- General purpose indicator application
- Electronic signs and electronics board

Certification & Compliance:

- TS16949
- ISO9001
- RoHS Compliant



Dimension:

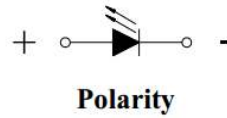
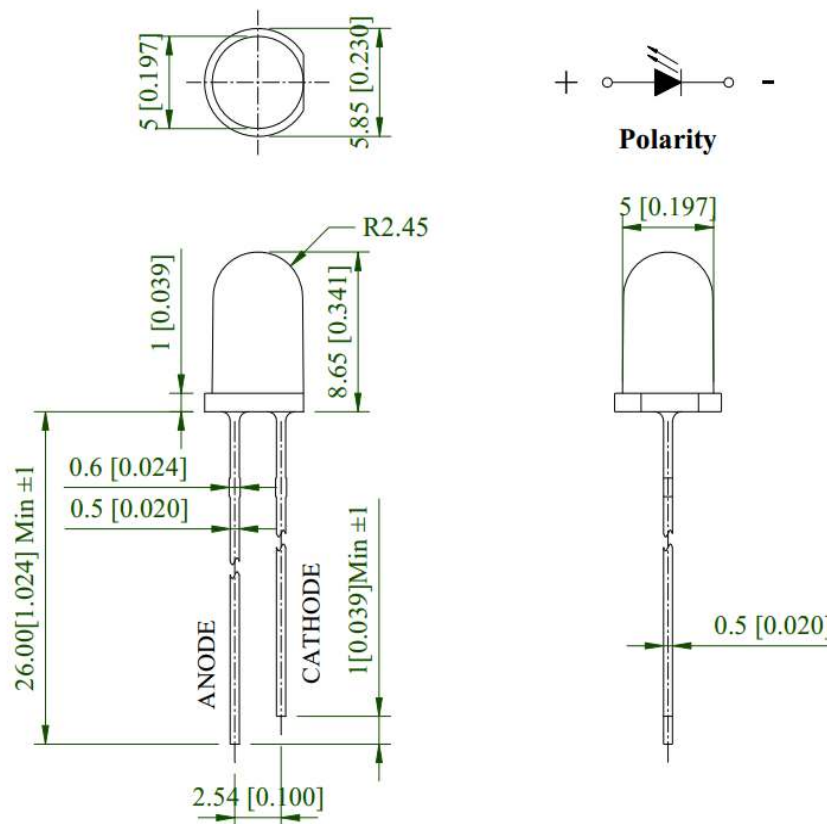

Units: mm / tolerance = +/-0.25mm unless otherwise specified

Electrical / Optical Characteristic (Ta=25°C)

Product	Color	I _F (mA)	V _F (V)		λ _D (nm)	I _V (mcd)	
			Typ.	Max.	Typ.	Min.	Typ.
QBL8R15C	Red	20	2.0	2.6	624	2900	5000
QBL8O15C	Orange	20	2.0	2.6	605	3800	6500
QBL8Y15C	Yellow	20	2.0	2.6	590	2900	5000
QBL8AG15C	Yellow Green	20	2.0	2.6	573	1000	1700
QBL8IG15C	True Green	20	3.2	3.6	525	30000	39000
QBL8IB15C	Blue	20	3.2	3.6	470	6500	11000

Absolute Maximum Rating

Material	P _d (mW)	I _F (mA)	I _{FP} (mA)*	V _R (V)	T _{OP} (°C)	T _{ST} (°C)
AlInGaP	65	25	100	5	-40 ~ +85	-40 ~ +100
InGaN	95	25	100	5	-40 ~ +85	-40 ~ +100

*1/10 Duty Cycle, 0.1ms Pulse Width

Characteristic Curves

AllnGaP

Forward Current & Forward Voltage

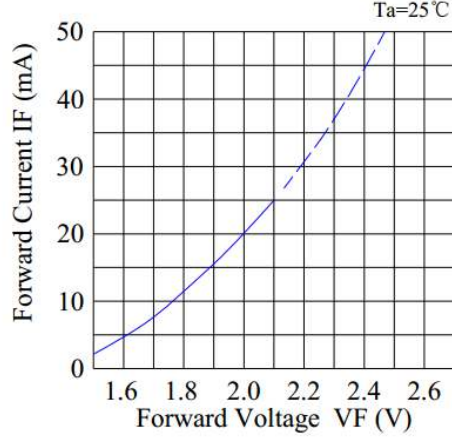

Luminous Intensity & Ambient Temperature

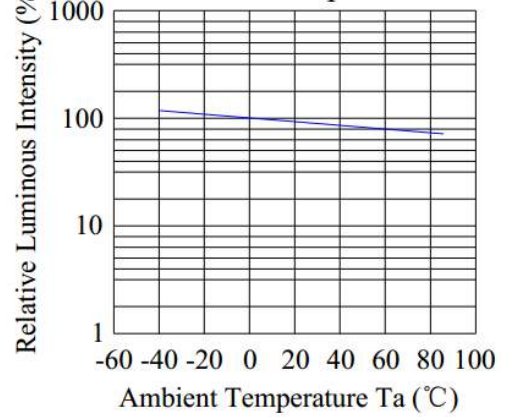

Forward Current Derating Curve

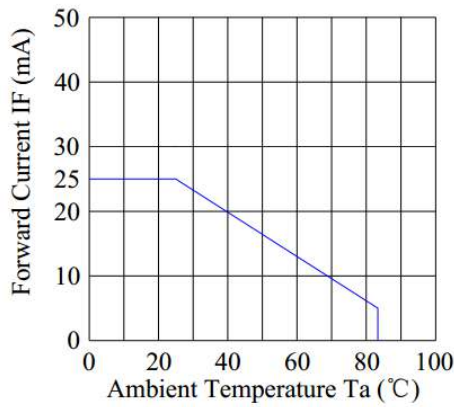

Luminous Intensity & Forward Current

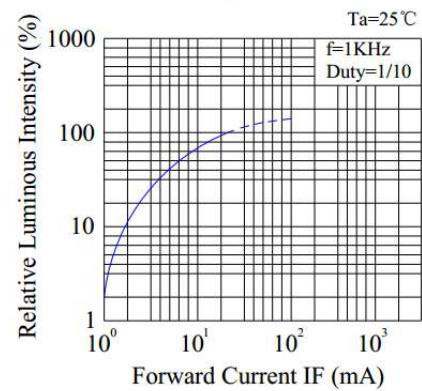

Relative Intensity vs. Wavelength

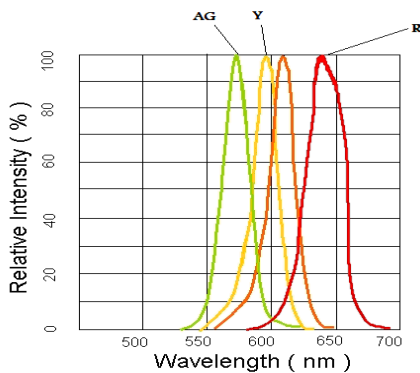

Radiation Diagram

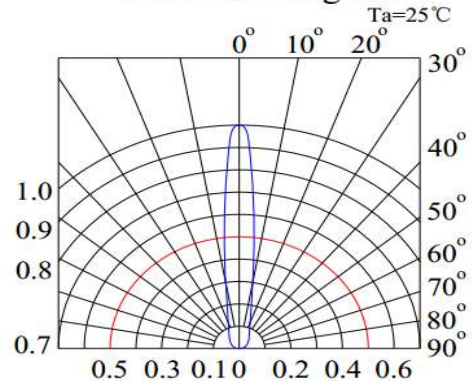

InGaN

Forward Current & Forward Voltage

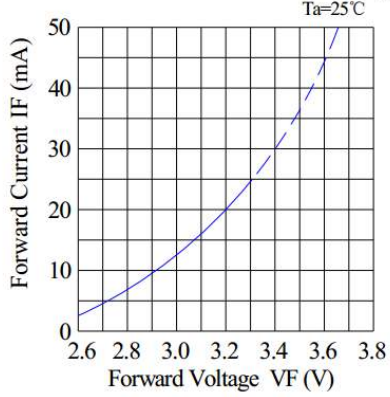

Luminous Intensity & Forward Current

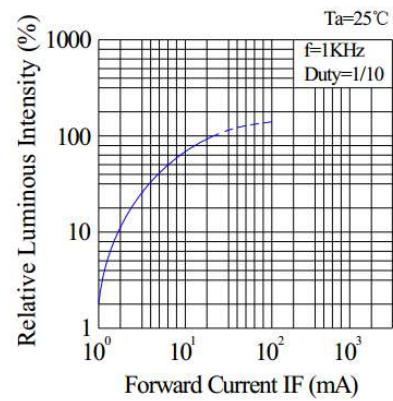

Luminous Intensity & Ambient Temperature

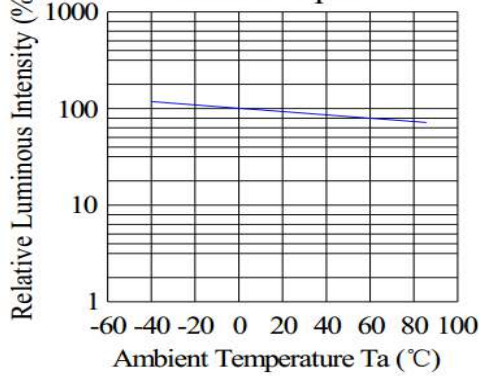

Forward Current Derating Curve

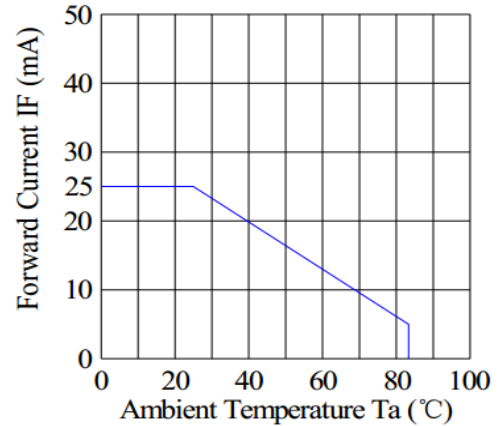

Relative Intensity vs. Wavelength

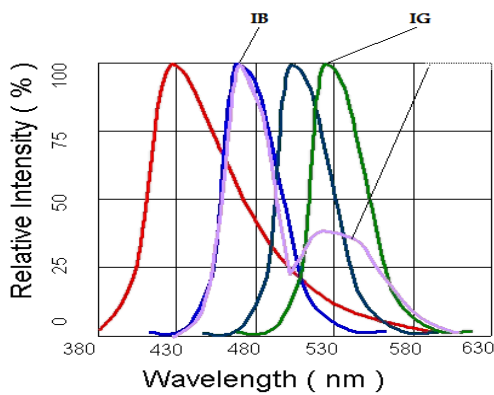

Radiation Diagram

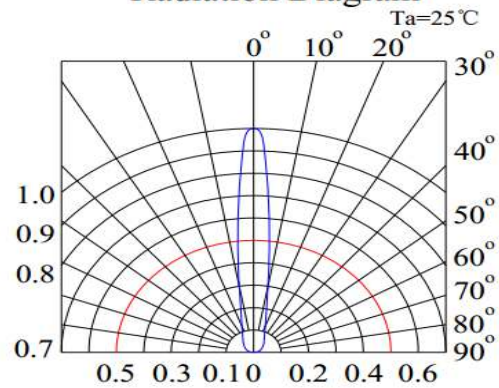

Ordering Information

Part #	Orderable Part #	Spec Range	Quantity per bag
QBL8R15C	QBL8R15C	Iv=5000mcd typ. @ 20mA, $\lambda_D=624\text{nm}$ typ.	500pcs
QBL8O15C	QBL8O15C	Iv=6500mcd typ. @ 20mA, $\lambda_D=605\text{nm}$ typ.	500pcs
QBL8Y15C	QBL8Y15C	Iv=5000mcd typ. @ 20mA, $\lambda_D=590\text{nm}$ typ.	500pcs
QBL8AG15C	QBL8AG15C	Iv=1700mcd typ. @ 20mA, $\lambda_D=573\text{nm}$ typ.	500pcs
QBL8IG15C	QBL8IG15C	Iv=39000mcd typ. @ 20mA, $\lambda_D=525\text{nm}$ typ.	500pcs
QBL8IB15C	QBL8IB15C	Iv=11000mcd typ. @ 20mA, $\lambda_D=470\text{nm}$ typ.	500pcs

Revision History

Description:	Revision #	Revision Date
New Release of QBL8XX15C_series	V1.0	06/25/2011
Update format	V1.1	08/21/2012
Amend spec	V1.2	11/12/2012
Update spec, dimension drawing and binning	V2.0	01/13/2016
Update spec and dimension drawing	V3.0	01/22/2018

Disclaimer

QT-BRIGHTEK reserves the right to make changes without further notice to any products herein to improve reliability, function or design. QT-BRIGHTEK does not assume any liability arising out of the application or use of any product or circuit described herein; neither does it convey any license under its patent rights, nor the rights of others.

Life Support Policy

QT-BRIGHTEK's products are not authorized for use as critical components in life support devices or systems without the express written approval of QT-BRIGHTEK. As used herein:

1. Life support devices or systems are devices or systems which, (a) are intended for surgical implant into the body, or (b) support or sustain life, and (c) whose failure to perform when properly used in accordance with instructions for use provided in the labeling, can be reasonably expected to result in a significant injury of the user.
2. A critical component in any component of a life support device or system whose failure to perform can be reasonably expected to cause the failure of the life support device or system, or to affect its safety or effectiveness.