

120MHz, Ultra-Low Noise Precision Operational Amplifiers

July 1997

Features

- **Slew Rate** 35V/ μ s
- **Wide Gain Bandwidth ($A_V \geq 10$)** 120MHz
- **Low Noise** 3nV/ $\sqrt{\text{Hz}}$ at 1kHz
- **Low V_{OS}** 10 μ V
- **High CMRR** 126dB
- **High Gain** 1800V/mV

Applications

- High Speed Signal Conditioners
- Wide Bandwidth Instrumentation Amplifiers
- Low Level Transducer Amplifiers
- Fast, Low Level Voltage Comparators
- Highest Quality Audio Preamplifiers
- Pulse/RF Amplifiers

Ordering Information

PART NUMBER (BRAND)	TEMP. RANGE (°C)	PACKAGE	PKG. NO.
HA2-5147-2	-55 to 125	8 Pin Metal Can	T8.C
HA2-5147-5	0 to 75	8 Pin Metal Can	T8.C
HA2-5147A-2	-55 to 125	8 Pin Metal Can	T8.C
HA2-5147A-5	0 to 75	8 Pin Metal Can	T8.C
HA3-5147-5	0 to 75	8 Ld PDIP	E8.3
HA7-5147-2	-55 to 125	8 Ld CERDIP	F8.3A
HA7-5147-5	0 to 75	8 Ld CERDIP	F8.3A
HA7-5147A-2	-55 to 125	8 Ld CERDIP	F8.3A
HA7-5147A-5	0 to 75	8 Ld CERDIP	F8.3A
HA9P5147-9 (H51479)	-40 to 85	8 Ld SOIC	M8.15

Description

The HA-5147 operational amplifier features an unparalleled combination of precision DC and wideband high speed characteristics. Utilizing the Harris D. I. technology and advanced processing techniques, this unique design unites low noise (3nV/ $\sqrt{\text{Hz}}$) precision instrumentation performance with high speed (35V/ μ s) wideband capability.

This amplifier's impressive list of features include low V_{OS} (10 μ V), wide gain bandwidth (120MHz), high open loop gain (1800V/mV), and high CMRR (126dB). Additionally, this flexible device operates over a wide supply range ($\pm 5V$ to $\pm 20V$) while consuming only 140mW of power.

Using the HA-5147 allows designers to minimize errors while maximizing speed and bandwidth in applications requiring gains greater than ten.

This device is ideally suited for low level transducer signal amplifier circuits. Other applications which can utilize the HA-5147's qualities include instrumentation amplifiers, pulse or RF amplifiers, audio preamplifiers, and signal conditioning circuits. Further application ideas are given in Application Note 553, Harris AnswerFAX (407-724-7800) document #9553.

This device can easily be used as a design enhancement by directly replacing the 725, OP25, OP06, OP07, OP27 and OP37 where gains are greater than ten. For military grade product, refer to the HA-5147/883 data sheet.

Pinouts

HA-5147 (CERDIP, PDIP, SOIC)
 HA-5147A (CERDIP, PDIP)
 TOP VIEW

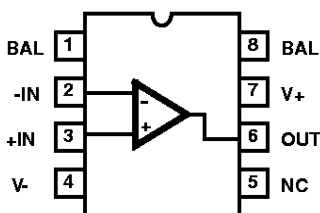

HA-5147, HA-5147A
 (METAL CAN)
 TOP VIEW

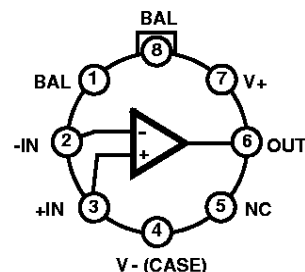

HA-5147, HA-5147A

Absolute Maximum Ratings $T_A = 25^\circ\text{C}$

Voltage Between V+ and V- Terminals	±44V
Differential Input Voltage (Note 1)	0.7V
Output Current	Full Short Circuit Protection

Operating Conditions

Temperature Range	
HA-5147/47A-2	-55°C to 125°C
HA-5147/47A-5	0°C to 75°C
HA-5147-9	-40°C to 85°C

Thermal Information

Thermal Resistance (Typical, Note 2)	θ_{JA} (°C/W)	θ_{JC} (°C/W)
CERDIP Package	135	50
Can Package	165	80
PDIP Package	120	N/A
SOIC Package	158	N/A
Maximum Junction Temperature (Hermetic Package)	175°C	
Maximum Junction Temperature (Plastic Package)	150°C	
Maximum Storage Temperature Range	-65°C to 150°C	
Maximum Lead Temperature (Soldering 10s)	300°C (SOIC - Lead Tips Only)	

Die Characteristics

Back Side Potential	V-
Number of Transistors	63

CAUTION: Stresses above those listed in "Absolute Maximum Ratings" may cause permanent damage to the device. This is a stress only rating and operation of the device at these or any other conditions above those indicated in the operational sections of this specification is not implied.

NOTES:

- For differential input voltages greater than 0.7V, the input current must be limited to 25mA to protect the back-to-back input diodes.
- θ_{JA} is measured with the component mounted on an evaluation PC board in free air.

Electrical Specifications $V_{SUPPLY} = \pm 15V, C_L \leq 50pF, R_S \leq 100\Omega$

PARAMETERS	TEST CONDITIONS	TEMP. (°C)	HA-5147			HA-5147A			UNITS
			MIN	TYP	MAX	MIN	TYP	MAX	
INPUT CHARACTERISTICS									
Offset Voltage		25	-	30	100	-	10	25	μV
		Full	-	70	300	-	30	60	μV
Average Offset Voltage Drift		Full	-	0.4	1.8	-	0.2	0.6	$\mu\text{V}/^\circ\text{C}$
Bias Current		25	-	15	80	-	10	40	nA
		Full	-	35	150	-	20	60	nA
Offset Current		25	-	12	75	-	7	35	nA
		Full	-	30	135	-	15	50	nA
Common Mode Range		Full	±10.3	±11.5	-	±10.3	±11.5	-	V
Differential Input Resistance (Note 3)		25	0.8	4	-	1.5	6	-	M Ω
Input Noise Voltage (Note 4)	0.1Hz to 10Hz	25	-	0.09	0.25	-	0.08	0.18	μV_{P-P}
Input Noise Voltage Density (Note 5)	f = 10Hz	25	-	3.8	8.0	-	3.5	8.0	$\text{nV}/\sqrt{\text{Hz}}$
	f = 100Hz		-	3.3	4.5	-	3.1	4.5	$\text{nV}/\sqrt{\text{Hz}}$
	f = 1000Hz		-	3.2	3.8	-	3.0	3.8	$\text{nV}/\sqrt{\text{Hz}}$
Input Noise Current Density (Note 5)	f = 10Hz	25	-	1.7	-	-	1.7	4.0	$\text{pA}/\sqrt{\text{Hz}}$
	f = 100Hz		-	1.0	-	-	1.0	2.3	$\text{pA}/\sqrt{\text{Hz}}$
	f = 1000Hz		-	0.4	0.6	-	0.4	0.6	$\text{pA}/\sqrt{\text{Hz}}$
TRANSFER CHARACTERISTICS									
Minimum Stable Gain		25	10	-	-	10	-	-	V/V
Large Signal Voltage Gain	$V_{OUT} = \pm 10V, R_L = 2k\Omega$	25	700	1500	-	1000	1800	-	V/mV
		Full	300	800	-	600	1200	-	V/mV

HA-5147, HA-5147A

Electrical Specifications $V_{SUPPLY} = \pm 15V$, $C_L \leq 50pF$, $R_S \leq 100\Omega$ (Continued)

PARAMETERS	TEST CONDITIONS	TEMP. (°C)	HA-5147			HA-5147A			UNITS
			MIN	TYP	MAX	MIN	TYP	MAX	
Common Mode Rejection Ratio	$V_{CM} = \pm 10V$	Full	100	120	-	114	126	-	dB
Gain-Bandwidth-Product	$f = 10kHz$	25	120	140	-	120	140	-	MHz
	$f = 1MHz$		-	120	-	-	120	-	MHz
OUTPUT CHARACTERISTICS									
Output Voltage Swing	$R_L = 600\Omega$	25	± 10.0	± 11.5	-	± 10.0	± 11.5	-	V
	$R_L = 2k\Omega$	Full	± 11.4	± 13.5	-	± 11.7	± 13.8	-	V
Full Power Bandwidth (Note 6)		25	445	500	-	445	500	-	kHz
Output Resistance	Open Loop	25	-	70	-	-	70	-	Ω
Output Current		25	16.5	25	-	16.5	25	-	mA
TRANSIENT RESPONSE (Note 7)									
Rise Time		25	-	22	50	-	22	50	ns
Slew Rate	$V_{OUT} = \pm 3V$	25	28	35	-	28	35	-	V/ μs
Settling Time	Note 8	25	-	400	-	-	400	-	ns
Overshoot		25	-	20	40	-	20	40	%
POWER SUPPLY CHARACTERISTICS									
Supply Current		25	-	3.5	-	-	3.5	-	mA
		Full	-	-	4.0	-	-	4.0	mA
Power Supply Rejection Ratio	$V_S = \pm 4V$ to $\pm 18V$	Full	-	16	51	-	2	4	$\mu V/V$

NOTES:

3. This parameter value is based upon design calculations.
4. Refer to Typical Performance section of the data sheet.
5. The limits for this parameter are guaranteed based on lab characterization, and reflect lot-to-lot variation.
6. Full power bandwidth guaranteed based on slew rate measurement using: $FPBW = \frac{\text{Slew Rate}}{2\pi V_{PEAK}}$.
7. Refer to Test Circuits section of the data sheet.
8. Settling time is specified to 0.1% of final value for a 10V output step and $A_V = -10$.

Test Circuits and Waveforms

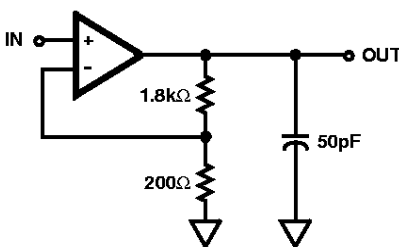
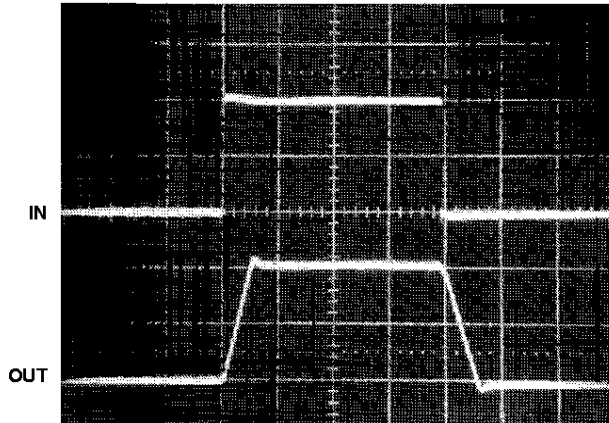

FIGURE 1. LARGE AND SMALL SIGNAL RESPONSE TEST CIRCUIT

Test Circuits and Waveforms (Continued)



Vertical Scale: Input = 0.5V/Div.
 Output = 5V/Div.
 Horizontal Scale: 500ns/Div.

LARGE SIGNAL RESPONSE

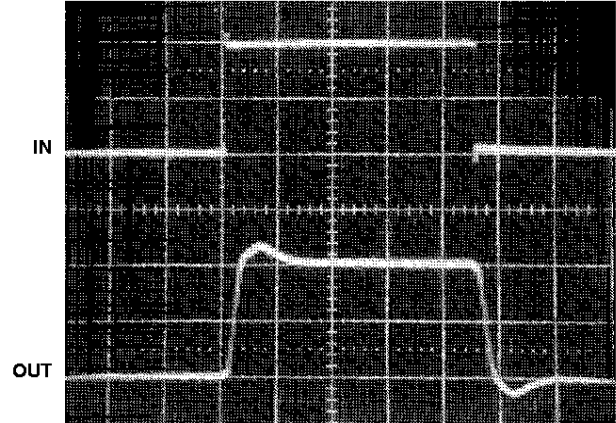

Vertical Scale: Input = 10mV/Div.
 Output = 100mV/Div.
 Horizontal Scale: 100ns/Div.

SMALL SIGNAL RESPONSE

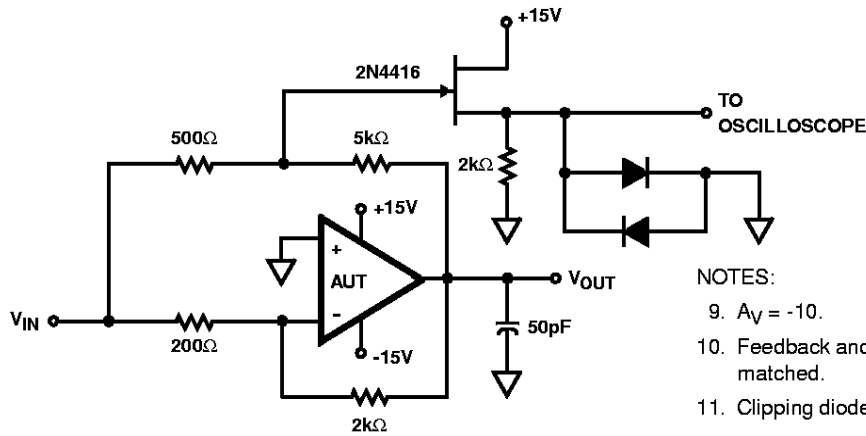

NOTES:

9. $A_V = -10$.
10. Feedback and summing resistors should be 0.1% matched.
11. Clipping diodes are optional. HP5082-2810 recommended.

FIGURE 2. SETTLING TIME TEST CIRCUIT

Schematic Diagram

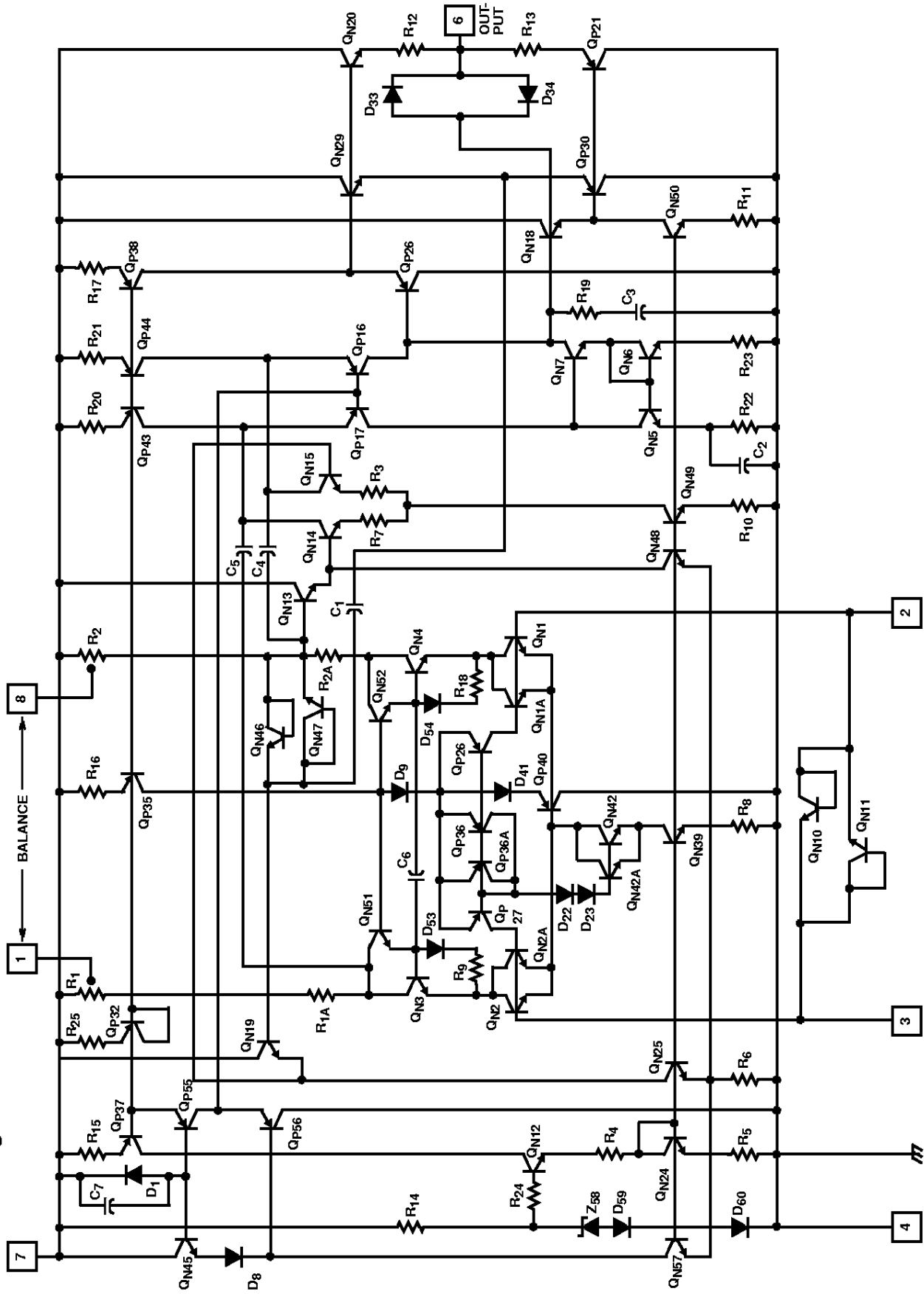

Application Information

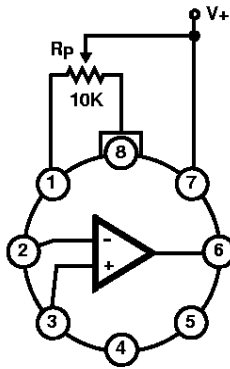

NOTE: Tested Offset Adjustment Range is $|V_{OS} + 1mV|$ minimum referred to output. Typical range is $\pm 4mV$ with $R_p = 10k\Omega$.

FIGURE 3. SUGGESTED OFFSET VOLTAGE ADJUSTMENT

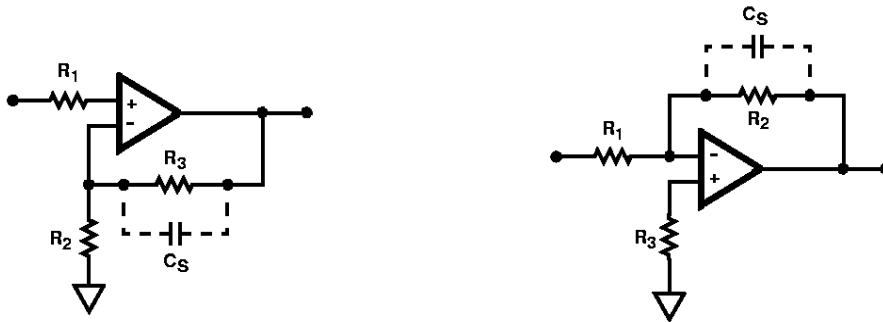

NOTE: Low resistances are preferred for low noise applications as a $1k\Omega$ resistor has $4nV/\sqrt{Hz}$ of thermal noise. Total resistances of greater than $10k\Omega$ on either input can reduce stability. In most high resistance applications, a few picofarads of capacitance across the feedback resistor will improve stability.

FIGURE 4. SUGGESTED STABILITY CIRCUITS

Typical Performance Curves $T_A = 25^\circ C$, $V_{SUPPLY} = \pm 15V$, Unless Otherwise Specified

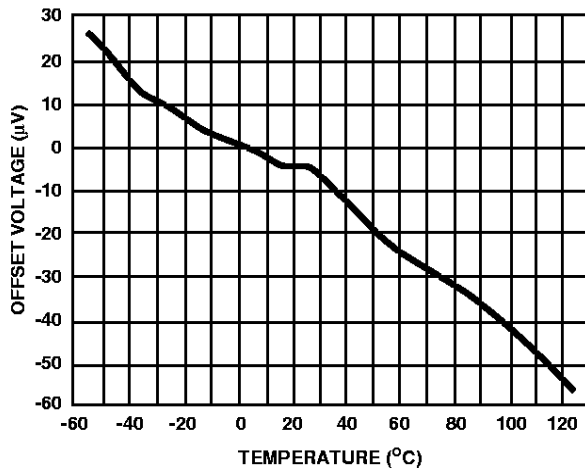

FIGURE 5. TYPICAL OFFSET VOLTAGE vs TEMPERATURE

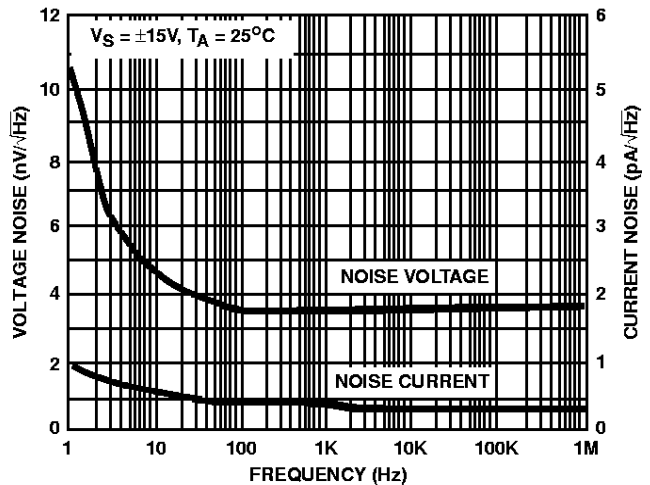

FIGURE 6. NOISE CHARACTERISTICS

Typical Performance Curves $T_A = 25^\circ\text{C}$, $V_{\text{SUPPLY}} = \pm 15\text{V}$, Unless Otherwise Specified (Continued)

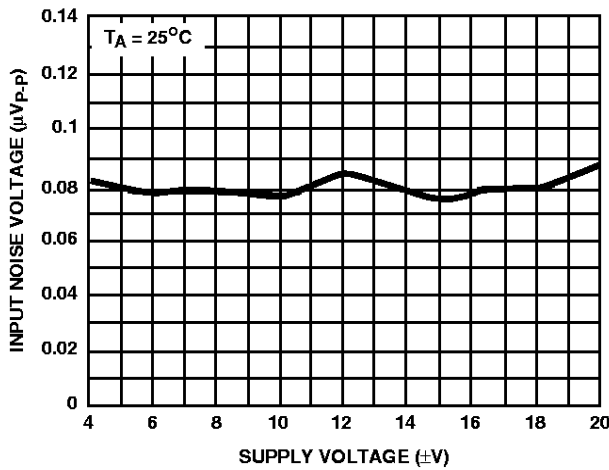

FIGURE 7. NOISE vs SUPPLY VOLTAGE

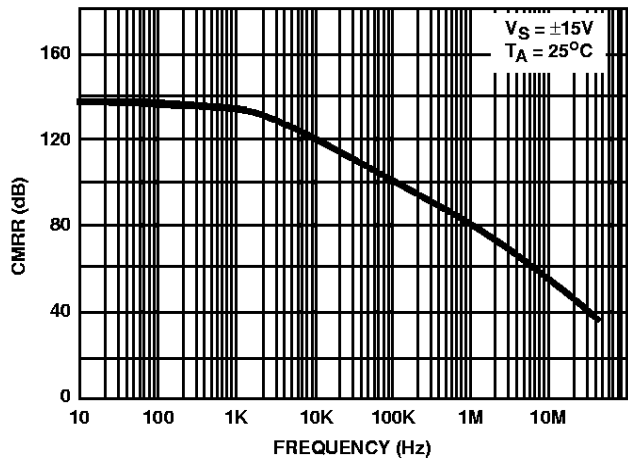

FIGURE 8. CMRR vs FREQUENCY

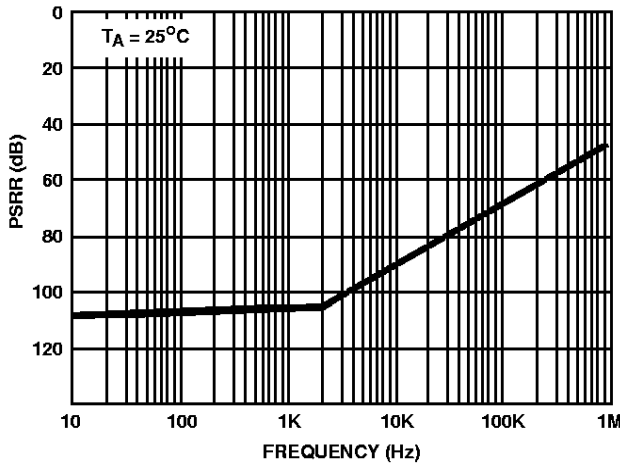

FIGURE 9. PSRR vs FREQUENCY

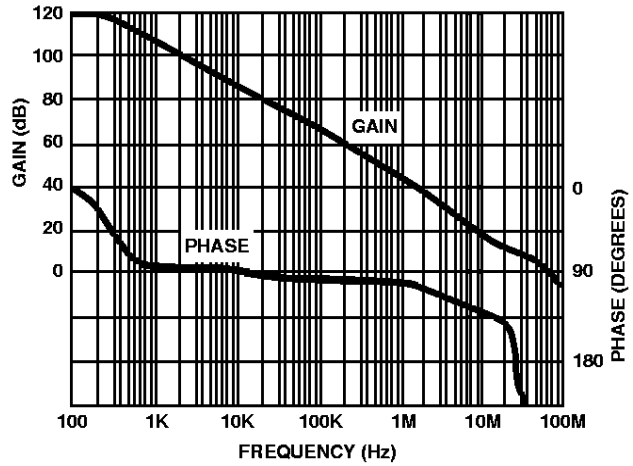

FIGURE 10. OPEN LOOP GAIN AND PHASE vs FREQUENCY

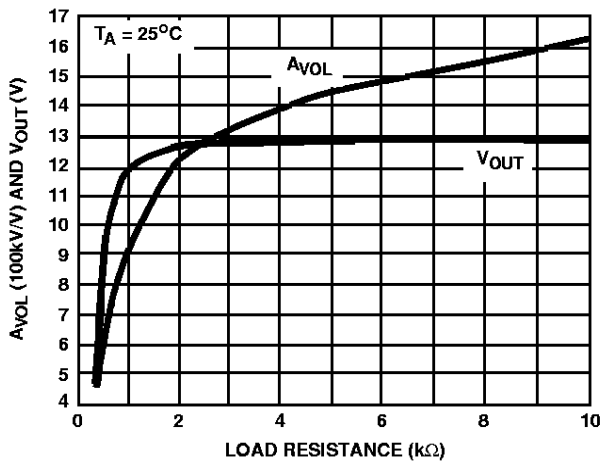

FIGURE 11. A_{VOL} AND V_{OUT} vs LOAD RESISTANCE

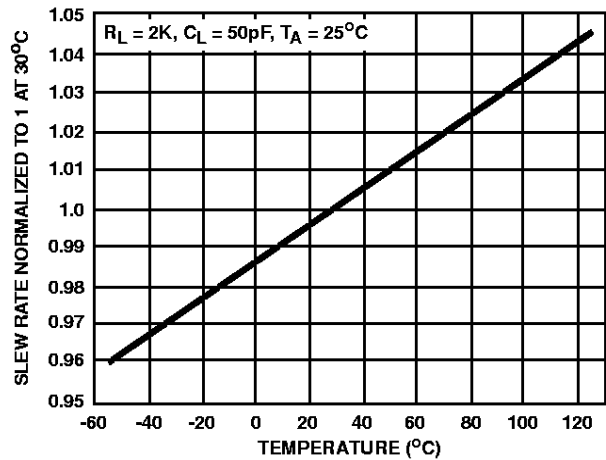

FIGURE 12. NORMALIZED SLEW RATE vs TEMPERATURE

Typical Performance Curves $T_A = 25^\circ\text{C}$, $V_{\text{SUPPLY}} = \pm 15\text{V}$, Unless Otherwise Specified (Continued)

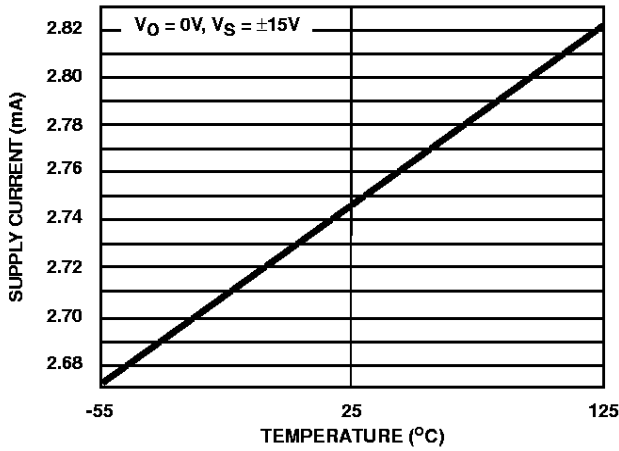

FIGURE 13. SUPPLY CURRENT vs TEMPERATURE

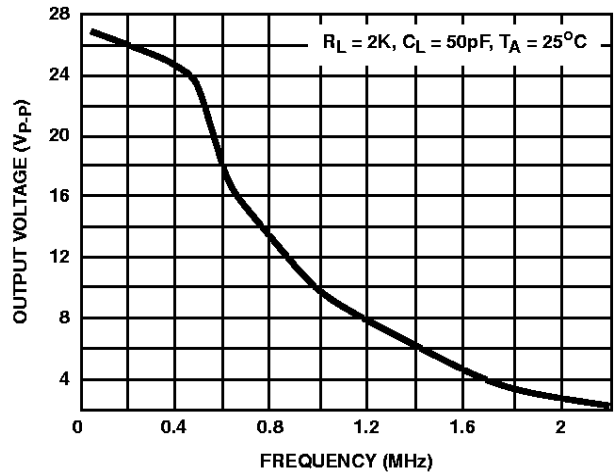

FIGURE 14. $V_{\text{OUT MAX}}$ (UNDISTORTED SINEWAVE OUTPUT) vs FREQUENCY

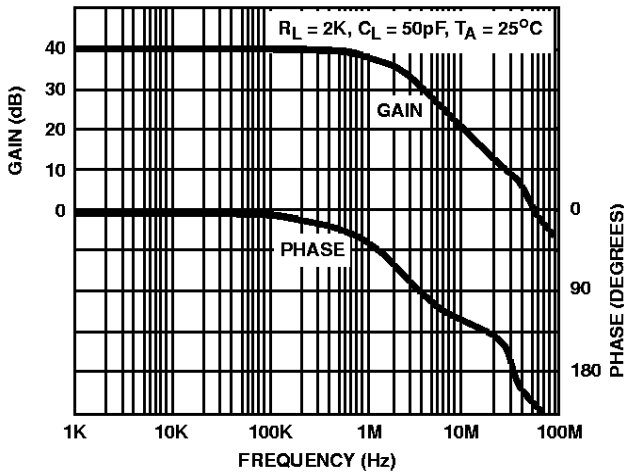
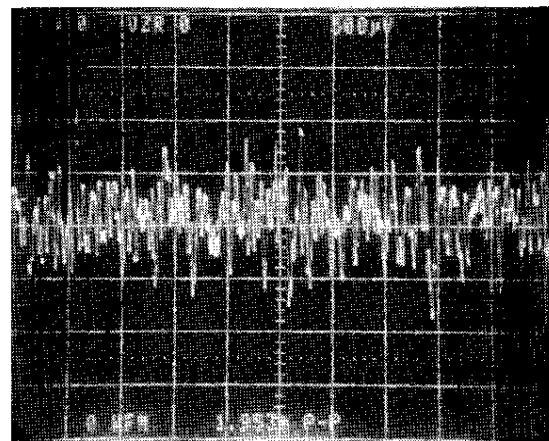

FIGURE 15. CLOSED LOOP GAIN AND PHASE vs FREQUENCY



$A_{\text{CL}} = 25,000\text{V/V}$; $E_{\text{N}} = 0.08\mu\text{V}_{\text{p-p RTI}}$
Horizontal Scale = 1s/Div.; Vertical Scale = 0.002µV/Div.

FIGURE 16. PEAK-TO-PEAK NOISE VOLTAGE (0.1Hz TO 10Hz)