

RT6200GE Evaluation Board

Purpose

The RT6200 is a high voltage Buck converter that can deliver up to 0.6A output current from a wide input voltage range of 4.5V to 36V. This document explains the function and use of the RT6200 evaluation board (EVB) and provides information to enable operation and modification of the evaluation board and circuit to suit individual requirements.

Table of Contents

PURPOSE.....	1
INTRODUCTION.....	2
KEY PERFORMANCE SUMMARY TABLE.....	2
BENCH TEST SETUP CONDITIONS.....	3
SCHEMATIC, BILL OF MATERIALS AND BOARD LAYOUT.....	5
MORE INFORMATION.....	9
IMPORTANT NOTICE FOR RICHTEK REFERENCE DESIGNS.....	9

Introduction

General Product Information

The RT6200 is a high voltage Buck converter that can support the input voltage range from 4.5V to 36V and the output current can be up to 0.6A. Current mode operation provides fast transient response and eases loop stabilization. The chip also provides protection functions such as cycle-by-cycle current limit and thermal shutdown protection. The RT6200 is available in the SOT-23-6 package.

Product Feature

- **Wide Operating Input Voltage Range : 4.5V to 36V**
- **Adjustable Output Voltage Range : 0.8V to 15V**
- **0.6A Output Current**
- **0.35Ω Internal Power MOSFET Switch**
- **High Efficiency up to 95%**
- **1.2MHz Fixed Switching Frequency (Duty <90%)**
- **Support duty up to 95%**
- **Stable with Low ESR Output Ceramic Capacitors**
- **Thermal Shutdown**
- **Cycle-By-Cycle Over-Current Protection**

Key Performance Summary Table

Key Features	Evaluation Board Number: PCB008_V1
Default Input Voltage	12V
Max Output Current	0.6A
Default Output Voltage	5V
Default Marking & Package Type	RT6200GE
Operation Frequency	Steady 1.2MHz at all loads
Other Key Features	4.5V to 36V Input Voltage Range Support duty up to 95%
Protection	Cycle-By-Cycle Over Current Protection Thermal Shutdown

Bench Test Setup Conditions

Headers Description and Placement

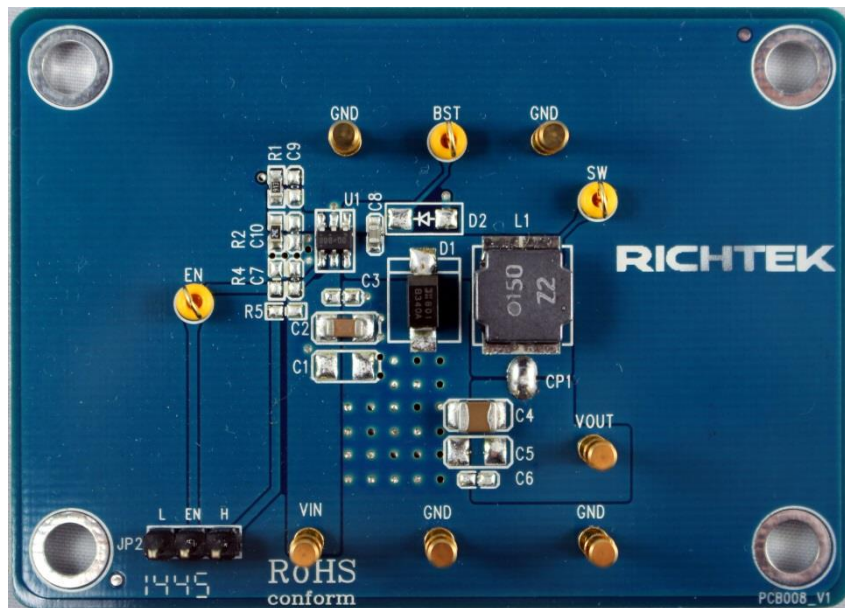

Please carefully inspect the EVB IC and external components, comparing them to the following Bill of Materials, to ensure that all components are installed and undamaged. If any components are missing or damaged during transportation, please contact the distributor or send e-mail to evb_service@richtek.com

Test Points

The EVB is provided with the test points and pin names listed in the table below.

Test point/ Pin name	Signal	Comment (expected waveforms or voltage levels on test points)
VIN	Input voltage	Input voltage range= 4.5V to 36V
VOUT	Output voltage	Default output voltage = 5.0V Output voltage range= 0.8V to 15V (see " Output Voltage Setting" section for changing output voltage level)
SW	Switching node test point	SW waveform
EN	Enable test point	Enable signal. EN is automatically pulled high by internal circuit to enable operation. Connect EN low (or by R4 pull low resistor) to disable operation.
BST	Boot strap supply test point	Floating supply voltage for the high-side N-MOSFET switch
GND	Ground	Ground

Power-up & Measurement Procedure

1. Apply a 12V nominal input power supply ($4.5V < V_{IN} < 36V$) to the VIN and GND terminals.
2. The EN voltage is pulled to logic high by internal circuit to enable operation. Drive EN high ($>2.5V$) to enable operation or low ($<0.4V$) to disable operation.
3. There is a 3-pin header JP2 "EN" for enable control. To use a jumper at "H" option to tie EN test pin to input power VIN for enabling the device. Inversely, to use a jumper at "L" option to tie EN test pin and ground GND for disabling the device.

4. Verify the output voltage (approximately 5.0V) between VOUT and GND.
5. Connect an external load up to 0.6A to the VOUT and GND terminals and verify the output voltage and current.

Output Voltage Setting

Set the output voltage with the resistive divider (R1, R2) between VOUT and GND with the midpoint connected to FB. The output is set by the following formula:

$$V_{OUT} = 0.8 \times \left(1 + \frac{R1}{R2}\right)$$

The installed V_{OUT} capacitor (C4) is 22 μ F, 16V X5R ceramic types. Do not exceed their operating voltage range and consider their voltage coefficient (capacitance vs. bias voltage) and ensure that the capacitance is sufficient to maintain stability and provide sufficient transient response for your application. This can be verified by checking the output transient response as described in the RT6200 IC datasheet.

Schematic, Bill of Materials & Board Layout

EVB Schematic Diagram

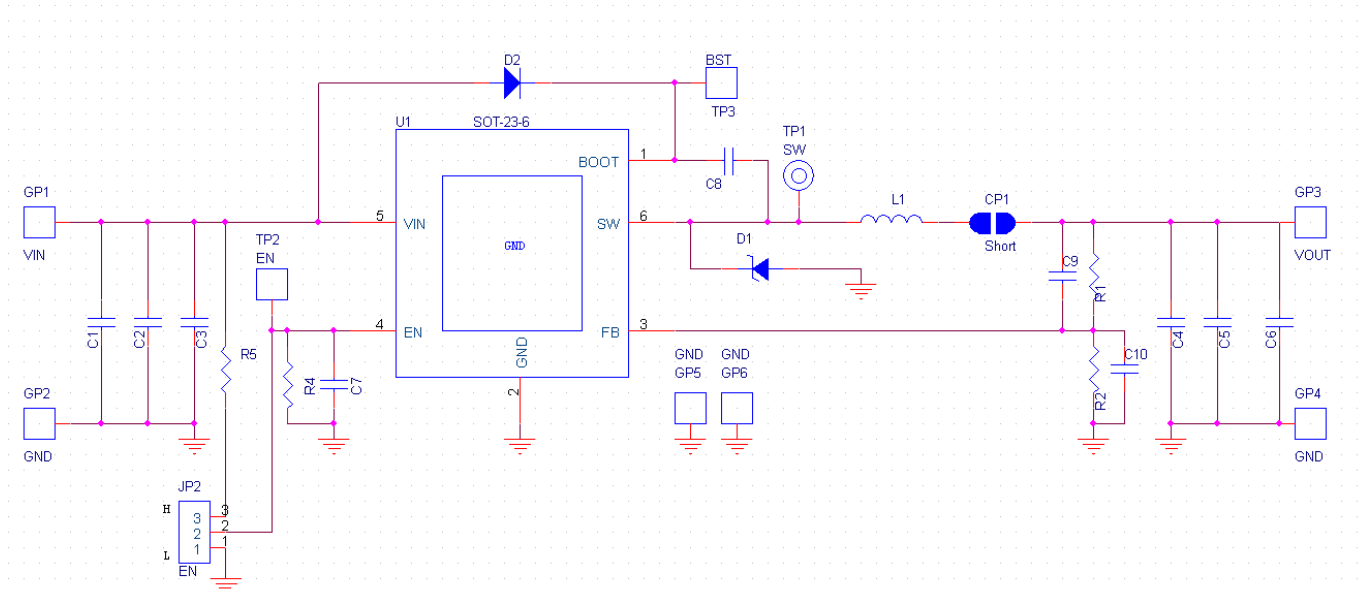

C2: 10 μ F/50V/X5R, 1206, TDK C3216X5R1H106K

C4: 22 μ F/16V/X5R, 1210, Murata GRM32ER61C226K

L1: 15 μ H TAIYO YUDEN NR8040T150M, DCR=50m Ω

Bill of Materials

Reference	Qty	Part number	Description	Package	Manufacture
U1	1	RT6200GE	DC-DC Converter	SOT-23-6	RICHTEK
C2	1	C3216X5R1H106K160AB	10 μ F/ \pm 10%/50V/X5R Ceramic Capacitor	1206	TDK
C4	1	GRM32ER61C226KE20#	22 μ F/ \pm 10%/16V/X5R Ceramic Capacitor	1210	Murata
C8	1	GRM32MR71H103KA01#	10nF/ \pm 10%/50V/X7R Ceramic Capacitor	0603	Murata
L1	1	NR8040T150M	15 μ H/2.7A/ \pm 20%, DCR=50m Ω , Inductor	8mmx8mmx4mm	TAIYO YUDEN
R1	1		91k Ω / \pm 1%, Resistor	0603	
R2	1		17.4k Ω / \pm 1%, Resistor	0603	
CP1	1		Short		
D1	1	B340A	40V/3A Schottky Diode		Diodes
JP2	1		3-Pin Header		
C1, C3, C5, C6, C7, C9, C10, R4, R5, D2	0		Not Installed	0603	
TP	3	BST, SW, EN	Test Pin		
GP	6	VIN, GND, VOUT, GND, GND, GND	Golden Pin		

EVB Layout

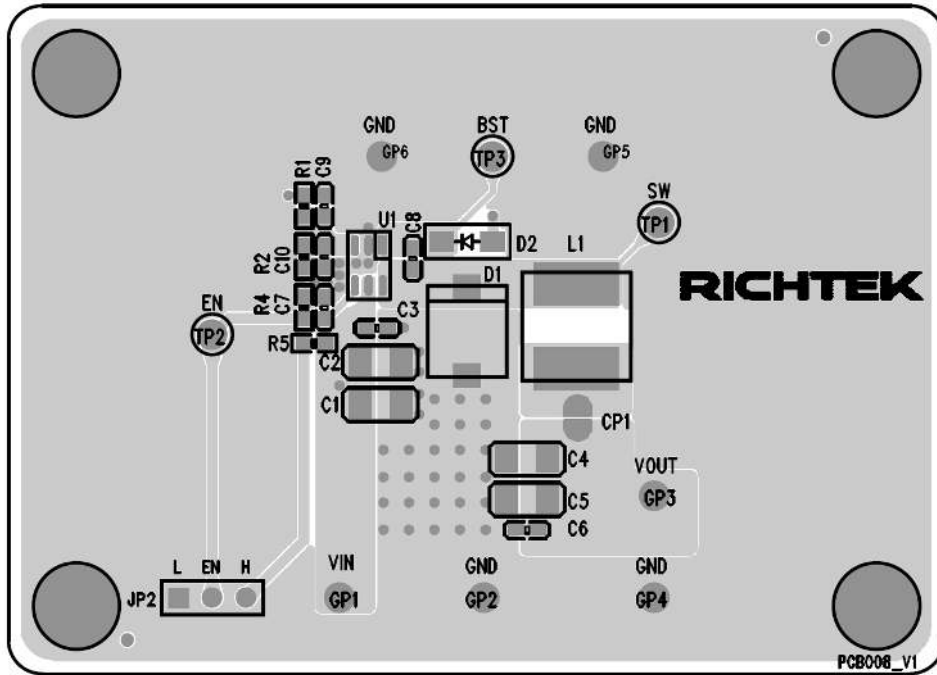

Top View (1st layer)

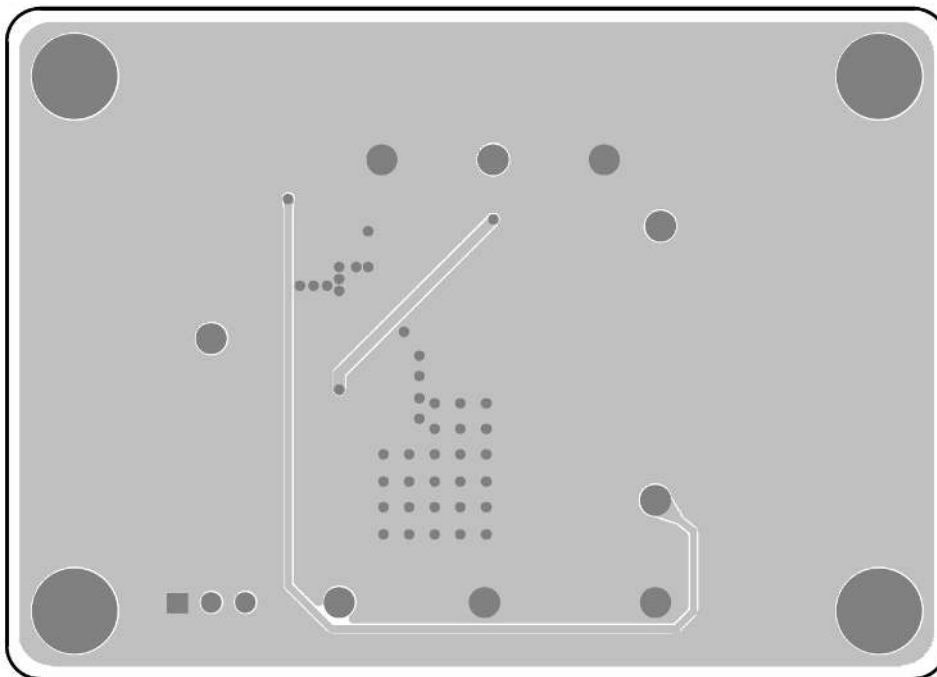

Bottom View (4th Layer)

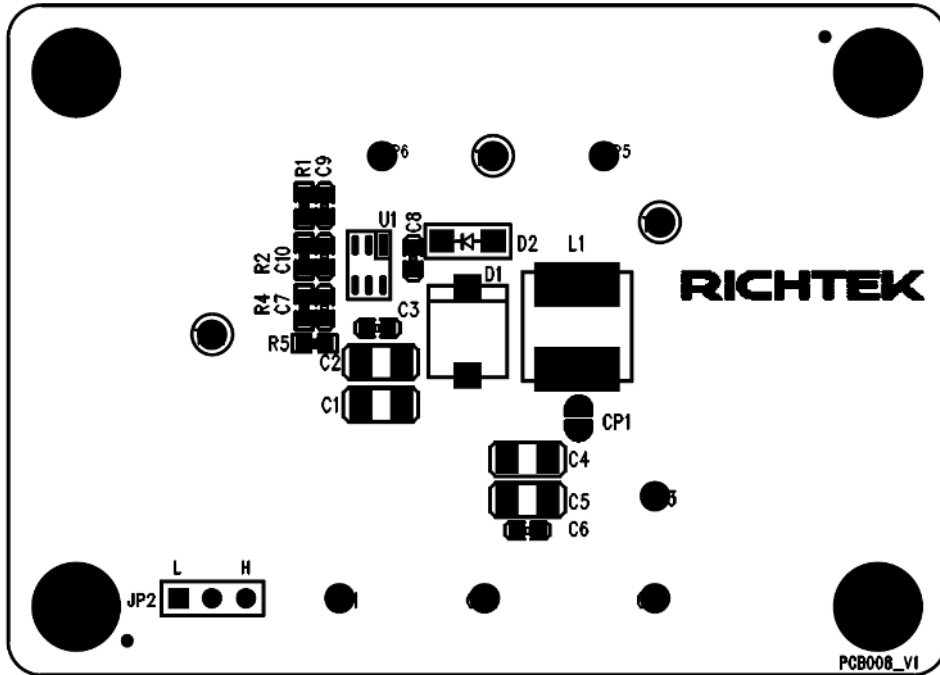

Component Placement Guide—Component Side (1st layer)

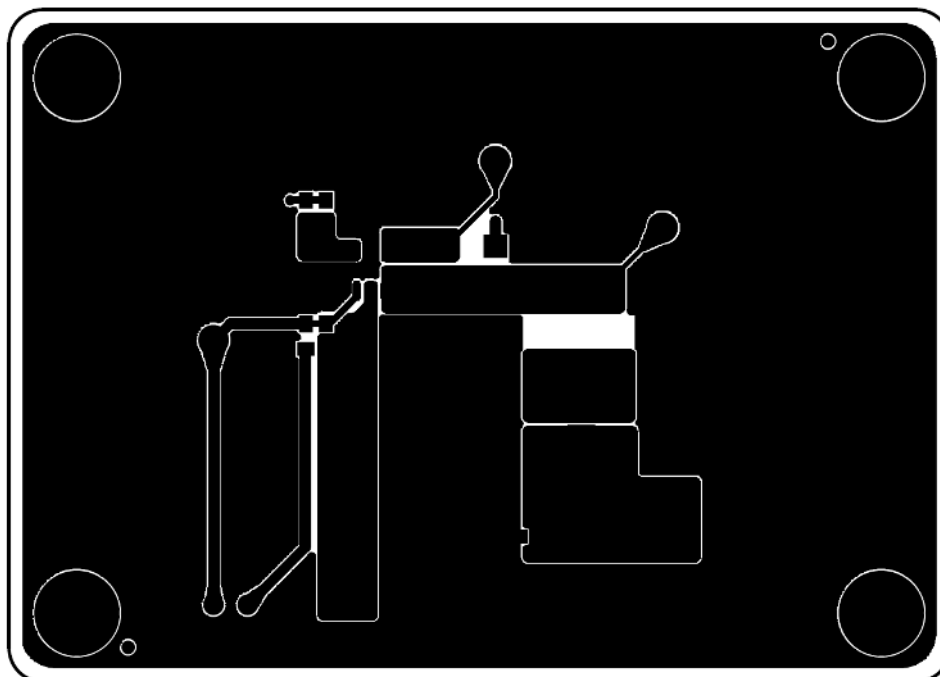

PCB Layout—Component Side (1st Layer)

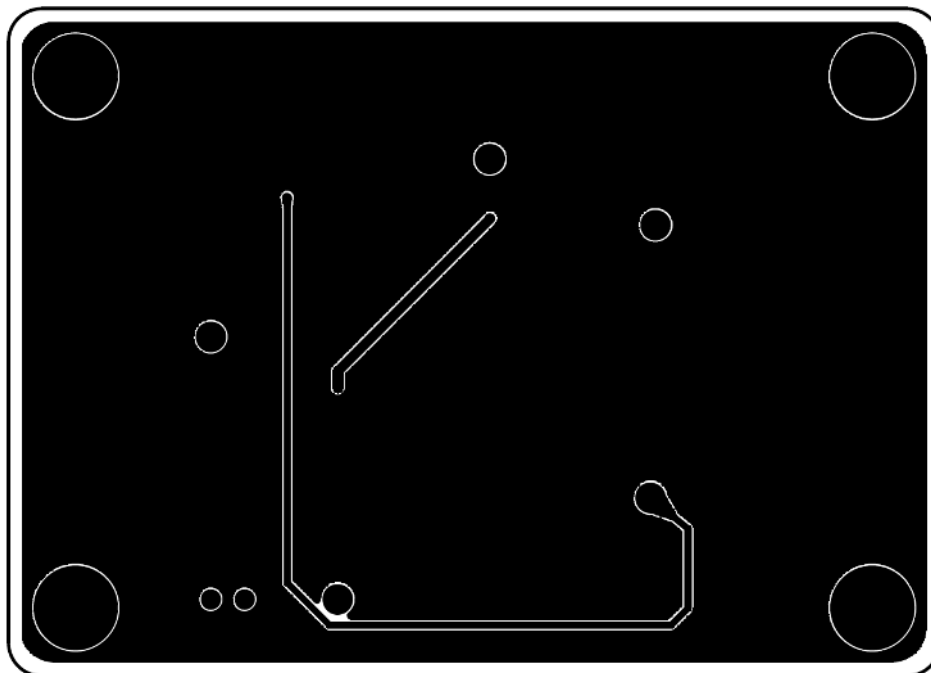

PCB Layout—Bottom Side (4th layer)

More Information

For more information, please find the related datasheet or application notes from Richtek website <http://www.richtek.com>.

Important Notice for Richtek Evaluation Board

THIS DOCUMENT IS FOR REFERENCE ONLY, NOTHING CONTAINED IN THIS DOCUMENT SHALL BE CONSTRUED AS RICHTEK'S WARRANTY, EXPRESS OR IMPLIED, UNDER CONTRACT, TORT OR STATUTORY, WITH RESPECT TO THE PRESENTATION HEREIN. IN NO EVENT SHALL RICHTEK BE LIABLE TO BUYER OR USER FOR ANY AND ALL DAMAGES INCLUDING WITHOUT LIMITATION TO DIRECT, INDIRECT, SPECIAL, PUNITIVE OR CONSEQUENTIAL DAMAGES.