



SPECIFICATION SHEET

SPECIFICATION SHEET NO.	N1116- SOT23S9014S0J6
DATE	Nov. 16, 2021
REVISION	A1
DESCRIPTION	<p>SMD Plastic-Encapsulate Transistors, SOT-23 series, 3 pads</p> <p>S9014 Type, NPN</p> <p>Collector Power Dissipation 200mW. Collector Current 100mA Max.</p> <p>Operating Temp. Range -55°C ~+150°C</p> <p>Package in Tape/Reel, 3000pcs/Reel</p> <p>RoHS/RoHS III compliant</p>
CUSTOMER	
CUSTOMER PART NUMBER	
CROSS REF. PART NUMBER	
ORIGINAL PART NUMBER	MDD S9014
PART CODE	SOT23S9014S0J6

VENDOR APPROVE			
Issued/Checked/Approved			
DATE: Nov. 16, 2021			

CUSTOMER APPROVE	
DATE:	

SMD PLASTIC-ENCAPULATE TRANSISTORS SOT23 SERIES

MAIN FEATURE

- Epitaxial planar die construction
- Complementary to P/N. S9015
- Collector Power Dissipation 200mW
- Collector Current 100mA.



APPLICATION

- For printed circuit board

RFQ

[Request For Quotation](#)

PART CODE GUIDE

SOT23	S9014	S	0J6
1	2	3	4

1) **SOT23**: SMD Plastic-Encapsulate Transistors, 3 pads SOT-23 series Code

2) **S9014**: Type code for S9014

3) **S**: Package code, Package in Tape/Reel, 3000pcs/Reel

4) **0J6**: Marking code for "J6" on the case surface, Different Marking for different specification.

SMD PLASTIC-ENCAPULATE TRANSISTORS SOT23 SERIES

DIMENSION (Unit: Inch/mm)

Image for reference

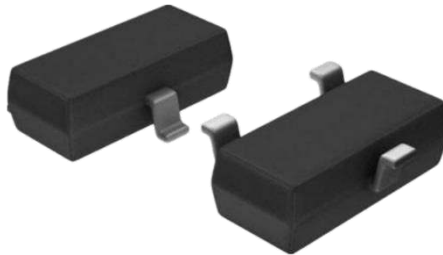

Marking: J6

SOT-23

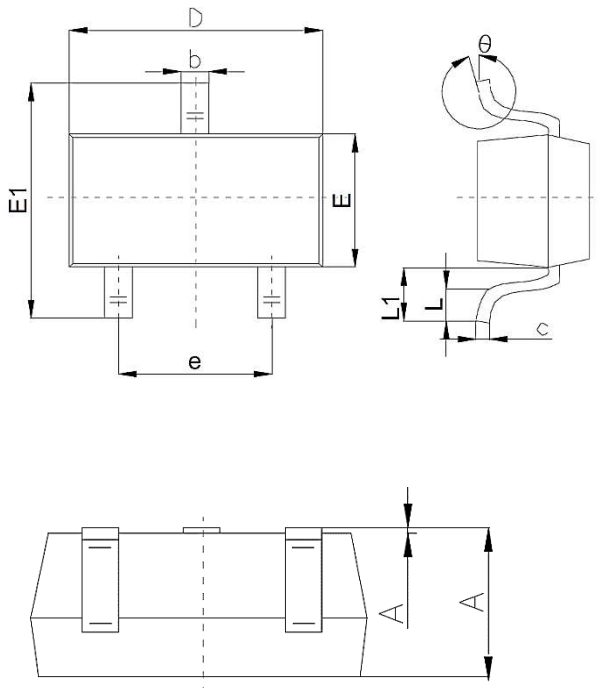

Symbol	Value (mm)		
	Min.	Typ.	Max.
A	1.0		1.4
A1			0.10
b	0.35		0.50
c	0.10		0.20
D	2.70	2.90	3.10
E	1.40		1.60
E1	2.40		2.80
e		1.9	
L	0.10		0.30
L1	0.40		
θ	0°		10°

Recommend Pad Layout

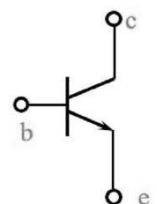
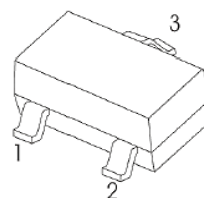
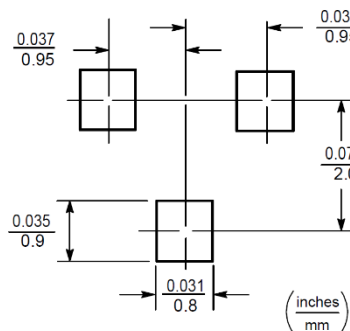

- 1.Base
- 2.Emitter
- 3.Collector

SMD PLASTIC-ENCAPULATE TRANSISTORS SOT23 SERIES

MECHANICAL DATA

Case	Terminals	Polarity	Mounting Position	Weight per piece
JEDEC SOT-23 molded plastic body	Solder plated, Solderable per MIL-STD-750, Method 2026	Polarity symbol marking on case	Any	0.00019 Ounce, 0.00591 grams

MAX. RATINGS AT Ta=25 °C

Parameter	SYMBOLS	VALUE	UNITS
		LIMIT	
Collector-Base Voltage	V _{CBO}	50	Volts
Collector-Emitter Voltage	V _{CEO}	45	Volts
Emitter-Base Voltage	V _{EBO}	5	Volts
Collector Current-Continuous	I _C	100	mA
Collector Power Dissipation	P _C	200	mW
Thermal Resistance Junction to Ambient	R _{QJA}	625	°C/W
Junction temperature	T _J	+150	°C
Storage temperature range	T _{STG}	-55 ~ +150	°C

SMD PLASTIC-ENCCAPULATE TRANSISTORS SOT23 SERIES
ELECTRICAL CHARACTERISTICS AT Ta= 25 °C

Parameter	SYMBOLS	VALUE			UNIT	Condition
		Min.	Typ.	Max.		
Collector-base breakdown voltage	$V_{(BR)CBO}$	50			V	$I_C = 100\mu A, I_E = 0$
Collector-emitter breakdown voltage	$V_{(BR)CEO}^*$	45			V	$I_C = 1mA, I_B = 0$
Emitter-base breakdown voltage	$V_{(BR)EBO}$	5			V	$I_E = 100\mu A, I_C = 0$
Collector cut-off current	I_{CBO}			0.1	μA	$V_{CB} = 50V, I_E = 0$
Collector cut-off current	I_{CEO}			1	μA	$V_{CE} = 35V, I_E = 0$
Emitter cut-off current	I_{EBO}			0.1	μA	$V_{EB} = 3V, I_C = 0$
DC Current gain	h_{FE}	200		1000		$V_{CE} = 5V, I_C = 1mA$
Collector-emitter saturation voltage	$V_{CE(sat)}$			0.3	V	$I_C = 100mA, I_B = 5mA$
				-		
Base-emitter saturation voltage	$V_{BE(sat)}$			1	V	$I_C = 100mA, I_B = 5mA$
				-		
Transition frequency	f_T	150			MHz	$V_{CE} = 5V, I_C = 10mA, f = 30MHz$
Delay time	t_d			-	ns	$V_{CC} = 3V, V_{BE} = -0.5V, I_C = 10mA, I_{B1} = -I_{B2} = 1.0mA$
Rise time	t_r			-	ns	
Storage time	t_s			-	ns	$V_{CC} = 3V, I_C = 10mA, I_{B1} = -I_{B2} = 1.0mA$
Fall time	t_f			-	ns	

CLASSIFICATION OF h_{FE}

Rank	L	H
Range	200 ~ 450	450 ~ 1000
Marking	J6	J6

SMD PLASTIC-ENCAPULATE TRANSISTORS SOT23 SERIES
RELIABILITY

Number	Experiment Items	Experiment Method And Conditions	Reference Documents
1	Solder Resistance Test	Test 260°C± 5°C for 10 ± 2 sec. Immerse body into solder 1/16" ± 1/32"	MIL-STD-750D METHOD-2031.2
2	Solderability Test	230°C ±5°C for 5 sec.	MIL-STD-750D METHOD-2026.1 0
3	Pull Test	1 kg in axial lead direction for 10 sec.	MIL-STD-750D METHOD-2036.4
4	Bend Test	0.5Kg Weight Applied To Each Lead, Bending Arcs 90 °C ± 5 °C For 3 Times	MIL-STD-750D METHOD-2036.4
5	High Temperature Reverse Bias Test	TA=100°C for 1000 Hours at VR=80% Rated VR	MIL-STD-750D METHOD-1038.4
6	Forward Operation Life Test	TA=25°C Rated Average Rectified Current	MIL-STD-750D METHOD-1027.3
7	Intermittent Operation Life Test	On state: 5 min with rated IRMS Power Off state: 5 min with Cool Forced Air. On and off for 1000 cycles.	MIL-STD-750D METHOD-1036.3
8	Pressure Cooker Test	15 PSIG, TA=121°C, 4 hours	MIL-S-19500 APPENOIXC
9	Temperature Cycling Test	-55°C~+125°C; 30 Minutes For Dwelled Time 5 minutes for transferred time. Total: 10 cycles.	MIL-STD-750D METHOD-1051.7
10	Thermal Shock Test	0°C for 5 minutes., 100°C for 5minutes, Total: 10 cycles	MIL-STD-750D METHOD-1056.7
11	Forward Surge Test	8.3ms Single Sale Sine-wave One Surge.	MIL-STD-750D METHOD-4066.4
12	Humidity Test	TA=65°C, RH=98% for 1000 hours.	MIL-STD-750D METHOD-1021.3
13	High Temperature Storage life Test	150°C for 1000 Hours	MIL-STD-750D METHOD-1031.5

SMD PLASTIC-ENCAPULATE TRANSISTORS SOT23 SERIES

SUGGESTED REFLOW PROFILE (For Reference Only)

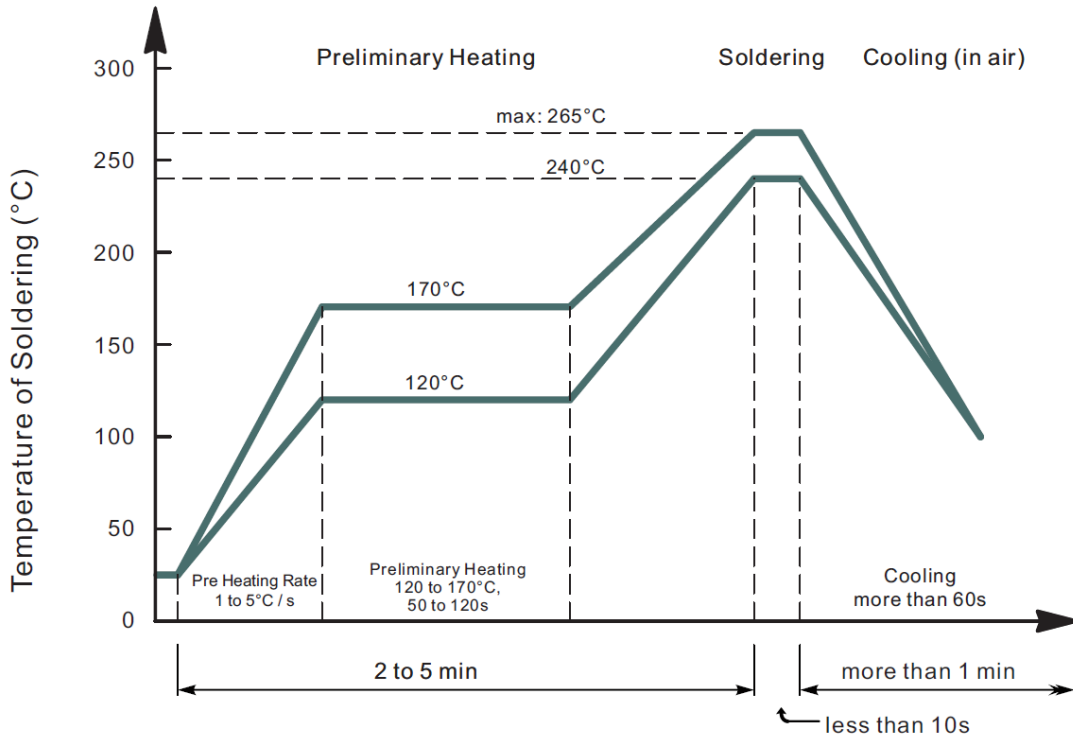

- Recommended peak temperature is over 245°C, If peak temperature is below 245 °C, you may adjust the following parameters; time length of peak temperature (longer), time length of soldering (longer), thickness of solder paste (thicker)
- Welding shall not exceed 2 times
- Remark: lead free solder paste (96.5 sn/3.0 Ag/0.5Cu)

SMD PLASTIC-ENCAPULATE TRANSISTORS SOT23 SERIES

RATINGS AND CHARACTERISTIC CURVES (For Reference Only)

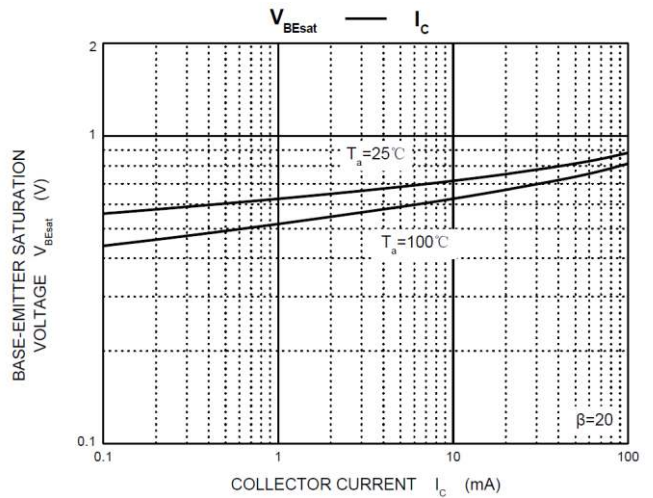
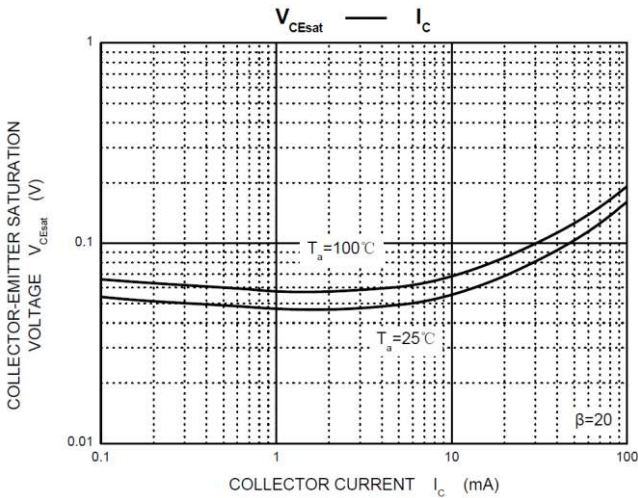
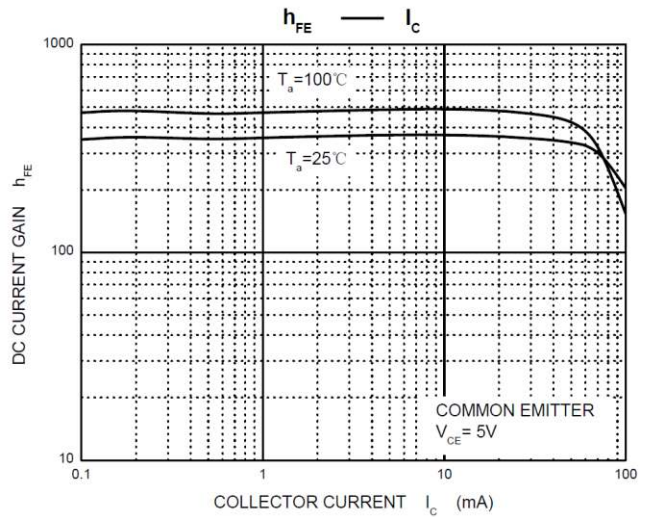
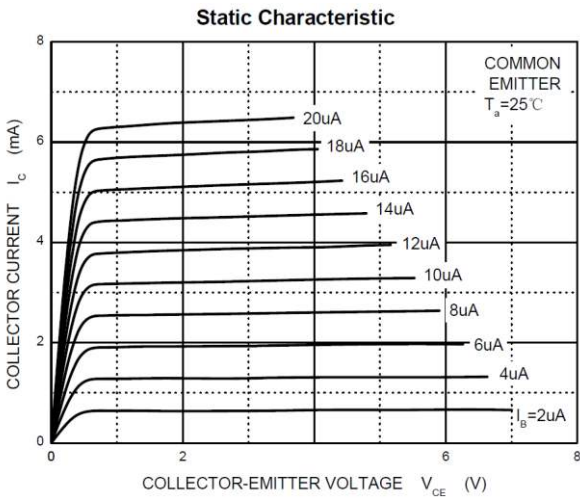

SMD PLASTIC-ENCCAPULATE TRANSISTORS SOT23 SERIES

RATINGS AND CHARACTERISTIC CURVES (For Reference Only)

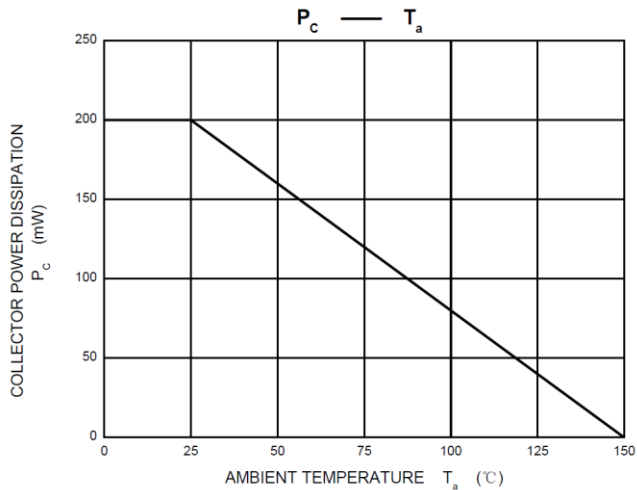
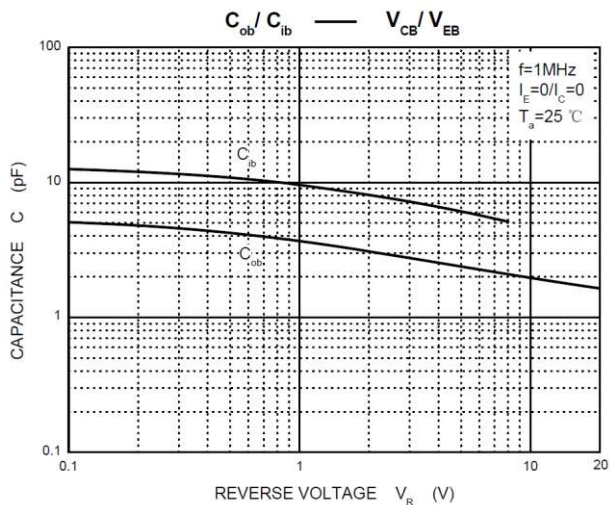
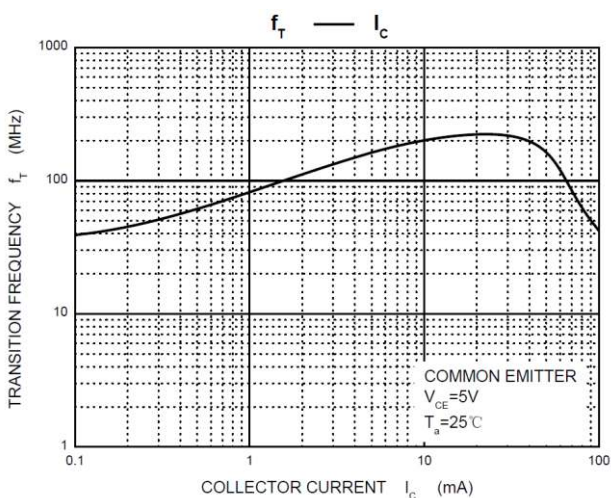
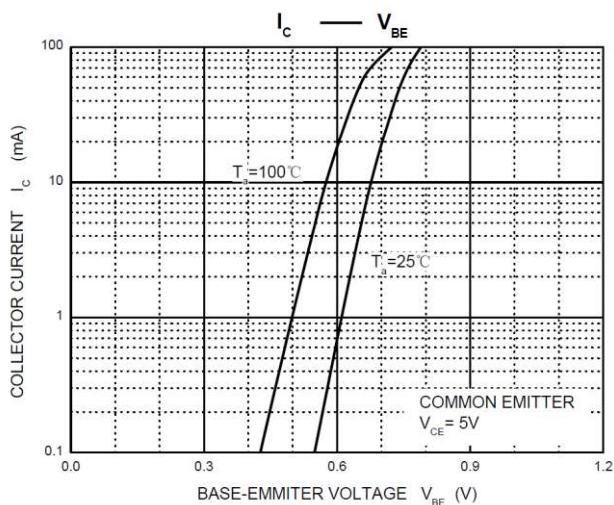

SMD PLASTIC-ENCAPULATE TRANSISTORS SOT23 SERIES

TAPE/REEL (Unit: mm)

All Devices are packed in accordance with EIA standard RS-481-A and specifications.

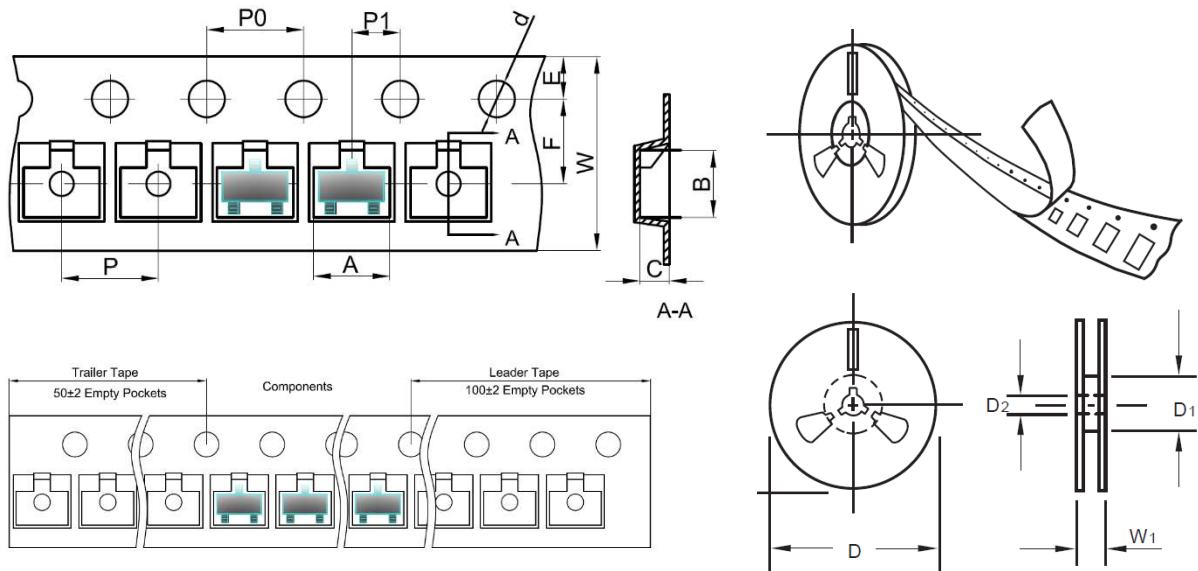

Item	Symbol	Tolerance	SOT-23
Carrier width	A	0.1	3.15
Carrier Length	B	0.1	2.77
Carrier Depth	C	0.1	1.22
Sprocket hole	d	0.05	1.55
7"Reel outside diameter	D	2.0	178.00
7"Reel inner diameter	D1	Min.	54.4
Feed hole diameter	D2	0.5	13.00
Sprocket hole position	E	0.1	1.75
Punch hole position	F	0.1	3.50
Punch hole pitch	P	0.1	4.00
Sprocket hole pitch	P0	0.1	4.00
Embossment center	P1	0.1	2.00
Overall tape thickness	T	0.1	0.25
Tape width	W	0.3	8.00
Reel width	W1	1.0	19.50

SMD PLASTIC-ENCAPULATE TRANSISTORS SOT23 SERIES

PACKAGE

Case Code	SOT-23
Reel Size	7"
Reel Size	178 mm
MPQ/Reel	3000 pcs
Qty. /Box	6000 pcs
G.W/Box	1 LBS

DISCLAIMER

NextGen Component, Inc. reserves the right to make changes to the product(s) and or information contained herein without notice. No liability is assumed as a result of their use or application. No rights under any patent accompany the sale of any such product(s) or information