

# CONTINUOUS VOLTAGE SMD CRYSTAL OSCILLATOR

ASADV

Request Samples



Check Inventory



ESD Sensitive



2.0 x 1.6 x 0.80mm

RoHS/RoHS II Compliant

MSL Level = 1

## Features

- Continuous Vdd operation from 1.6 V ~ 3.63 V
- Optimized for low current consumption
- Output Enable/Start & Disable/Stop function
- Output waveform CMOS/HCMOS/LVCMOS compatible
- Hermetically seam-sealed ceramic package

## Applications

- Portable & wearable electronics
- Internet of Things (IoT)
- Consumer electronics
- Industrial control & automation
- Mobile communication

## Electrical Specifications

Parameters	Min.	Typ.	Max.	Units	Notes
Frequency Range	1.25		100	MHz	
Operating Temperature Range	-40		+85	°C	See options
Storage Temperature Range	-55		+125	°C	
Overall Frequency Stability [Note 1]	-25		+25	ppm	See options
Supply Voltage (Vdd)	1.6		3.63	V	
Tri-state function	"1" (VIH ≥ 0.7*Vdd) or Open: Oscillation; "0" (VIL < 0.3*Vdd): No Oscillation/Hi Z			V	
Output Load			15	pF	CMOS
Output Voltage	VOH	0.9*Vdd		V	
	VOL		0.1*Vdd		
Aging 1 year @25°C ± 3°C	-3.0		+3.0	ppm	
Aging 5 years @25°C ± 3°C	-5.0		+5.0	ppm	
Symmetry @ ½ Vdd	45	50	55	%	
Start-up Time			5.0	ms	
Rise and Fall Time (Tr/Tf) @10%Vdd-90%Vdd, 15pF load	Vdd = 1.8V to 3.63V		8.0	ns	1.25MHz ≤ F ≤ 19.999MHz
			6.0		20MHz ≤ F ≤ 39.999MHz
			5.0		40MHz ≤ F ≤ 69.999MHz
			5.0		70MHz ≤ F ≤ 100MHz
	Vdd = 1.6V		10.0		1.25MHz ≤ F ≤ 19.999MHz
			8.0		20MHz ≤ F ≤ 39.999MHz
			6.0		40MHz ≤ F ≤ 69.999MHz
			6.0		70MHz ≤ F ≤ 100MHz
RMS Period Jitter @25°C ± 3°C	Vdd = 3.0V to 3.63V		5.0	ps	
	Vdd = 1.6V to 2.5V		7.0		
RMS Phase Jitter @25°C ± 3°C (10 - 39MHz: 12kHz to 5MHz) (>39MHz: 12kHz to 20MHz)			1.0	ps	
Disable Current			10.0	µA	

\*Note 1: Overall frequency stability includes initial frequency tolerance @25°C ± 3°C and stability over the operating temperature range.



5101 Hidden Creek Ln Spicewood TX 78669  
 Phone: 512-371-6159 | Fax: 512-351-8858  
 For terms and conditions of sales, please visit:  
[www.abracon.com](http://www.abracon.com)

REVISED: 10-26-22

ABRACON IS  
 ISO9001-2015  
 CERTIFIED

# CONTINUOUS VOLTAGE SMD CRYSTAL OSCILLATOR

ASADV

Request Samples



Check Inventory



ESD Sensitive



2.0 x 1.6 x 0.80mm  
RoHS/RoHS II Compliant  
MSL Level = 1

## Electrical Specifications *continued*

Parameters	Min.	Typ.	Max.	Units	Notes
Supply Current (I <sub>dd</sub> ) into 15pF Load @25°C± 3°C @ V <sub>dd</sub> =3.3V			2.0	mA	1.25MHz ≤ F ≤ 5.999MHz
			2.0		6MHz ≤ F ≤ 9.999MHz
			3.0		10MHz ≤ F ≤ 19.999MHz
			4.0		20MHz ≤ F ≤ 29.999MHz
			5.0		30MHz ≤ F ≤ 39.999MHz
			5.0		40MHz ≤ F ≤ 45.999MHz
			5.0		46MHz ≤ F ≤ 48.999MHz
			6.0		49MHz ≤ F ≤ 50.999MHz
			8.0		51MHz ≤ F ≤ 54.999MHz
			8.0		55MHz ≤ F ≤ 60.999MHz
			12.5		61MHz ≤ F ≤ 75.999MHz
			14.5		76MHz ≤ F ≤ 80.999MHz
			14.5		81MHz ≤ F ≤ 100MHz
	Supply Current (I <sub>dd</sub> ) into 15pF Load @25°C± 3°C @ V <sub>dd</sub> =2.5V				1.3
			1.3	6MHz ≤ F ≤ 9.999MHz	
			2.0	10MHz ≤ F ≤ 19.999MHz	
			3.0	20MHz ≤ F ≤ 29.999MHz	
			3.5	30MHz ≤ F ≤ 39.999MHz	
			4.5	40MHz ≤ F ≤ 45.999MHz	
			4.5	46MHz ≤ F ≤ 48.999MHz	
			5.0	49MHz ≤ F ≤ 50.999MHz	
			6.5	51MHz ≤ F ≤ 54.999MHz	
			7.0	55MHz ≤ F ≤ 60.999MHz	
			10.0	61MHz ≤ F ≤ 75.999MHz	
			11.5	76MHz ≤ F ≤ 80.999MHz	
			11.5	81MHz ≤ F ≤ 100MHz	
Supply Current (I <sub>dd</sub> ) into 15pF Load @25°C± 3°C @ V <sub>dd</sub> =1.8V				1.0	mA
			1.0	6MHz ≤ F ≤ 9.999MHz	
			1.6	10MHz ≤ F ≤ 19.999MHz	
			2.2	20MHz ≤ F ≤ 29.999MHz	
			2.5	30MHz ≤ F ≤ 39.999MHz	
			3.0	40MHz ≤ F ≤ 45.999MHz	
			3.5	46MHz ≤ F ≤ 48.999MHz	
			3.5	49MHz ≤ F ≤ 50.999MHz	
			3.5	51MHz ≤ F ≤ 54.999MHz	
			4.0	55MHz ≤ F ≤ 60.999MHz	
			9.0	61MHz ≤ F ≤ 75.999MHz	
			9.0	76MHz ≤ F ≤ 80.999MHz	
			10.0	81MHz ≤ F ≤ 100MHz	



5101 Hidden Creek Ln Spicewood TX 78669  
Phone: 512-371-6159 | Fax: 512-351-8858  
For terms and conditions of sales, please visit:  
www.abracon.com

REVISED: 10-26-22

ABRACON IS  
ISO9001-2015  
CERTIFIED

# CONTINUOUS VOLTAGE SMD CRYSTAL OSCILLATOR

ASADV

Request Samples



Check Inventory



2.0 x 1.6 x 0.80mm  
RoHS/RoHS II Compliant  
MSL Level = 1



ESD Sensitive



## Typical Current Consumption (I<sub>dd</sub>) vs. Supply Voltage (V<sub>dd</sub>) Characteristics @ 25°C ± 3°C [Load = 15pF]

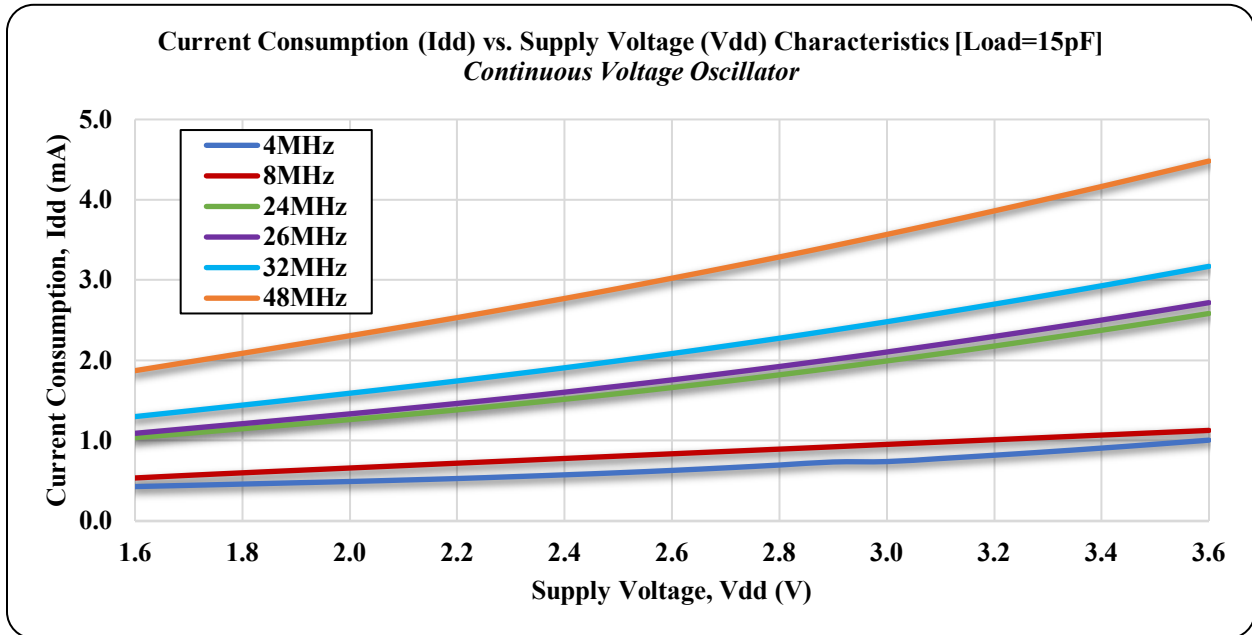

## Typical Frequency vs. Supply Voltage (V<sub>dd</sub>) Characteristics @ 25°C ± 3°C

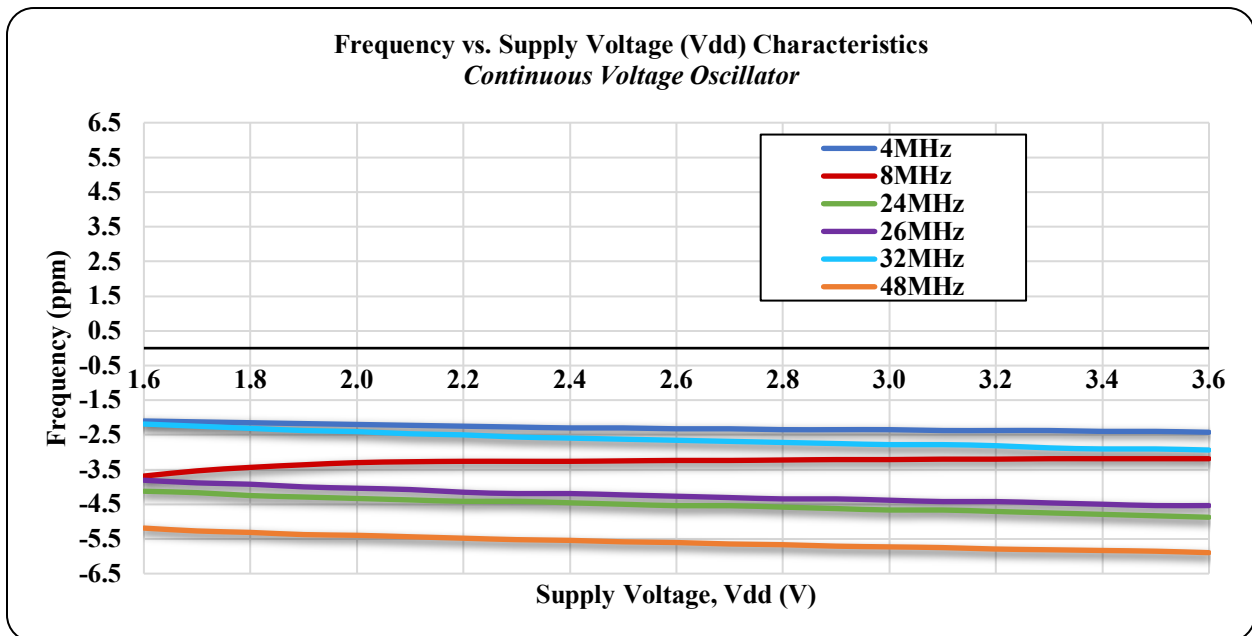

5101 Hidden Creek Ln Spicewood TX 78669  
Phone: 512-371-6159 | Fax: 512-351-8858  
For terms and conditions of sales, please visit:  
[www.abracon.com](http://www.abracon.com)

REVISED: 10-26-22

ABRACON IS  
ISO9001-2015  
CERTIFIED

# CONTINUOUS VOLTAGE SMD CRYSTAL OSCILLATOR

ASADV

Request Samples



Check Inventory



2.0 x 1.6 x 0.80mm  
RoHS/RoHS II Compliant  
MSL Level = 1



ESD Sensitive



Pb

## Typical Frequency vs. Temperature Characteristics

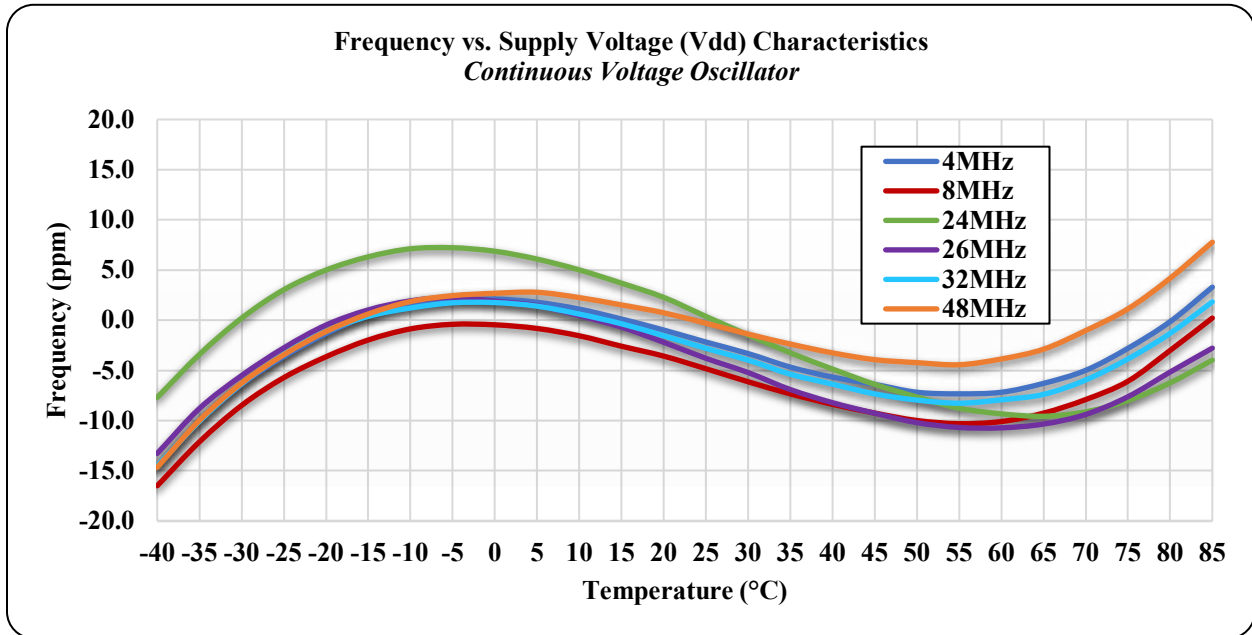

## Part Identification

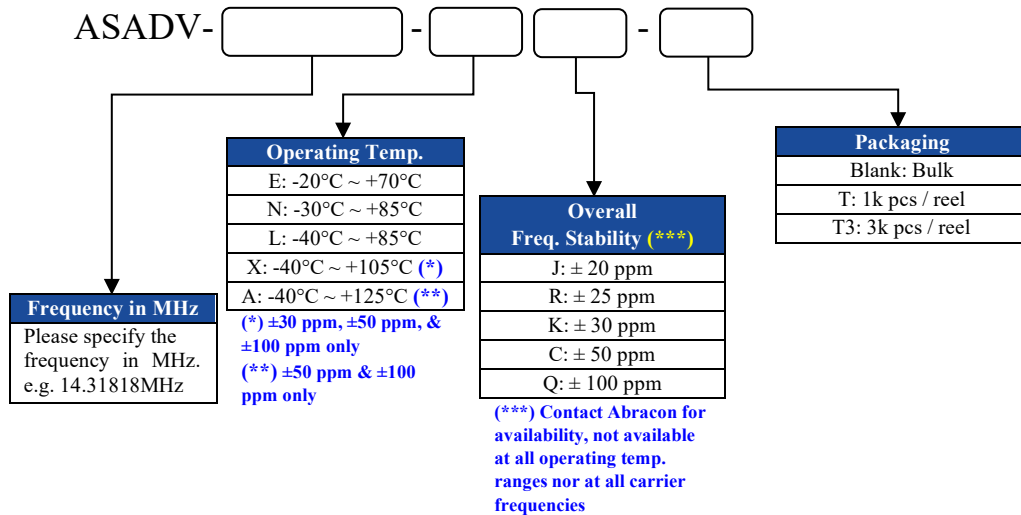

5101 Hidden Creek Ln Spicewood TX 78669  
Phone: 512-371-6159 | Fax: 512-351-8858  
For terms and conditions of sales, please visit:  
www.abracon.com

REVISED: 10-26-22

ABRACON IS  
ISO9001-2015  
CERTIFIED

# CONTINUOUS VOLTAGE SMD CRYSTAL OSCILLATOR

ASADV

Request Samples



Check Inventory



2.0 x 1.6 x 0.80mm  
 RoHS/RoHS II Compliant  
 MSL Level = 1



ESD Sensitive



Pb

## Mechanical Dimensions

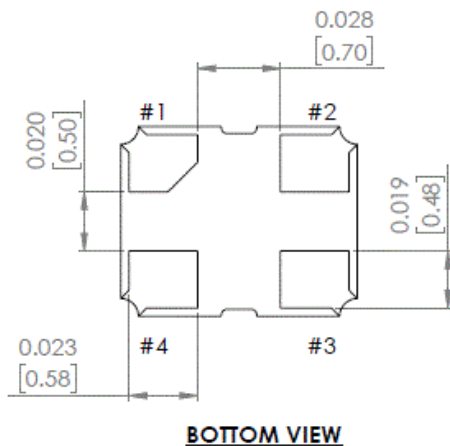
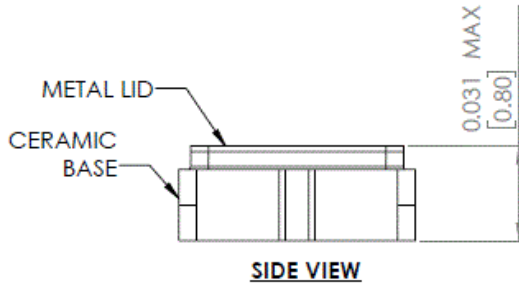
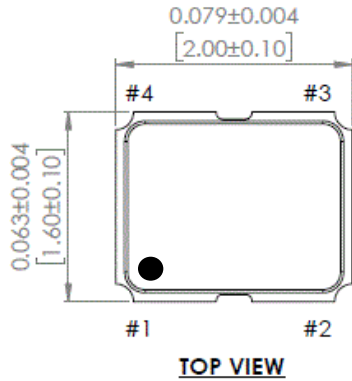

### Recommended Land Pattern

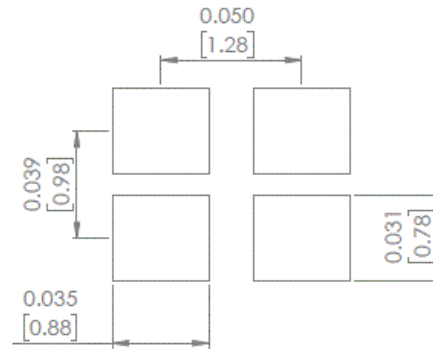

Pin #	Function
1	Tri-State
2	GND
3	Output
4	Vdd

Note: Recommended to use approximately 0.01µF bypass capacitor between PIN 2 and PIN 4

Dimensions: inches (mm)



5101 Hidden Creek Ln Spicewood TX 78669  
 Phone: 512-371-6159 | Fax: 512-351-8858  
 For terms and conditions of sales, please visit:  
[www.abracon.com](http://www.abracon.com)

REVISED: 10-26-22

ABRACON IS  
 ISO9001-2015  
 CERTIFIED

# CONTINUOUS VOLTAGE SMD CRYSTAL OSCILLATOR

ASADV

Request Samples



Check Inventory



2.0 x 1.6 x 0.80mm  
RoHS/RoHS II Compliant  
MSL Level = 1



ESD Sensitive



## Reflow Profile [JEDEC J-STD-020]

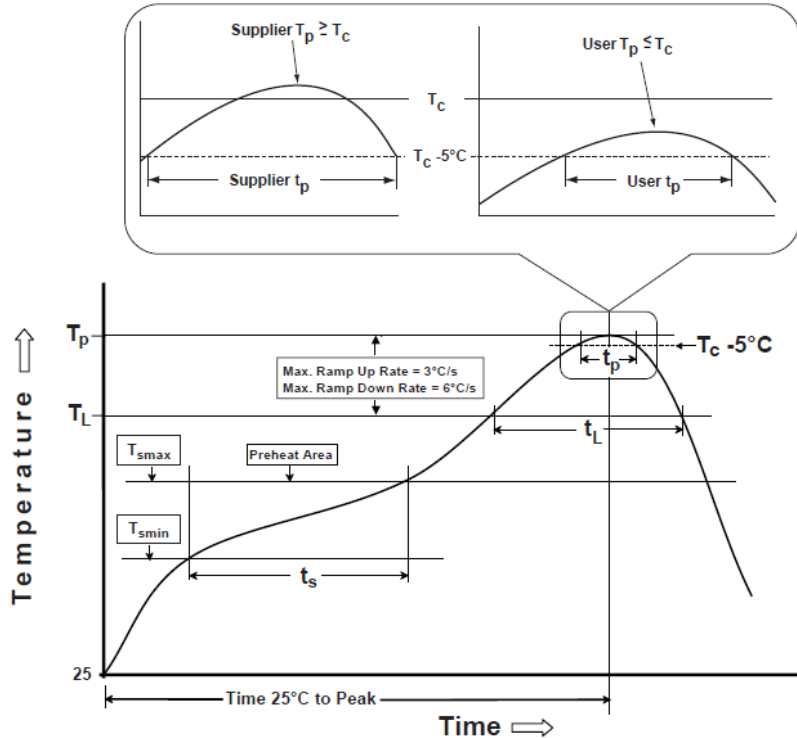

Table 1

SnPb Eutectic Process  
Classification Temperatures ( $T_c$ )

Package Thickness	Volume mm <sup>3</sup> <350	Volume mm <sup>3</sup> ≥350
<2.5 mm	235 °C	220 °C
≥2.5 mm	220 °C	220 °C

Table 2

Pb-Free Process  
Classification Temperatures ( $T_c$ )

Package Thickness	Volume mm <sup>3</sup> <350	Volume mm <sup>3</sup> 350-2000	Volume mm <sup>3</sup> >2000
<1.6 mm	260 °C	260 °C	260 °C
1.6 mm - 2.5 mm	260 °C	250 °C	245 °C
>2.5 mm	250 °C	245 °C	245 °C

Profile Feature	Sn-Pb Eutectic Assembly	Pb-Free Assembly
Preheat / soak		
Temperature minimum ( $T_{smin}$ )	100°C	150°C
Temperature maximum ( $T_{smax}$ )	150°C	200°C
Time ( $T_{smin}$ to $T_{smax}$ ) ( $t_s$ )	60 - 120 sec.	60 - 120 sec.
Average ramp-up rate ( $T_{smax}$ to $T_p$ )	3°C/sec. max	3°C/sec. max
Liquidous temperature ( $T_L$ )	183°C	217°C
Time at liquidous ( $t_L$ )	60 - 150 sec.	60 - 150 sec.
Peak package body temperature ( $T_p$ )*	see Table 1	see Table 2
Time ( $t_p$ )** within 5°C of the specified classification temperature ( $T_c$ )	20 sec.	30 sec.
Ramp-down rate ( $T_p$ to $T_{smax}$ )	6°C/sec. max	6°C/sec. max
Time 25°C to peak temperature	6 min. max	8 min. max
Reflow cycles	2 max	2 max

\*Tolerance for peak profile temperature ( $T_p$ ) is defined as a supplier minimum and a user maximum.

\*\*Tolerance for time at peak profile temperature ( $t_p$ ) is defined as supplier minimum and a user maximum.



5101 Hidden Creek Ln Spicewood TX 78669  
Phone: 512-371-6159 | Fax: 512-351-8858  
For terms and conditions of sales, please visit:  
www.abracon.com

REVISED: 10-26-22

ABRACON IS  
ISO9001-2015  
CERTIFIED

# CONTINUOUS VOLTAGE SMD CRYSTAL OSCILLATOR

ASADV

Request Samples



Check Inventory



2.0 x 1.6 x 0.80mm  
RoHS/RoHS II Compliant  
MSL Level = 1



ESD Sensitive



## Packaging

T: 1,000pcs/reel (500021, 500240)  
T3: 3,000pcs/reel (500021, 500240, 500603)

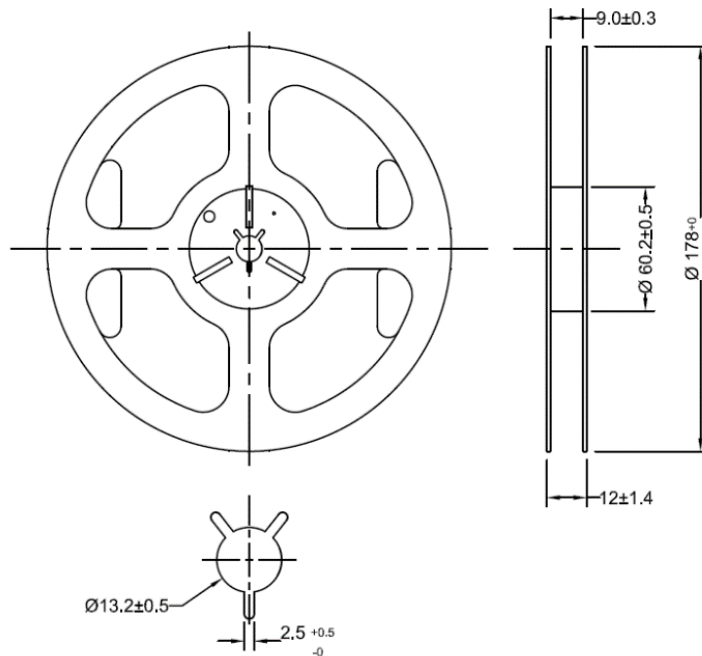
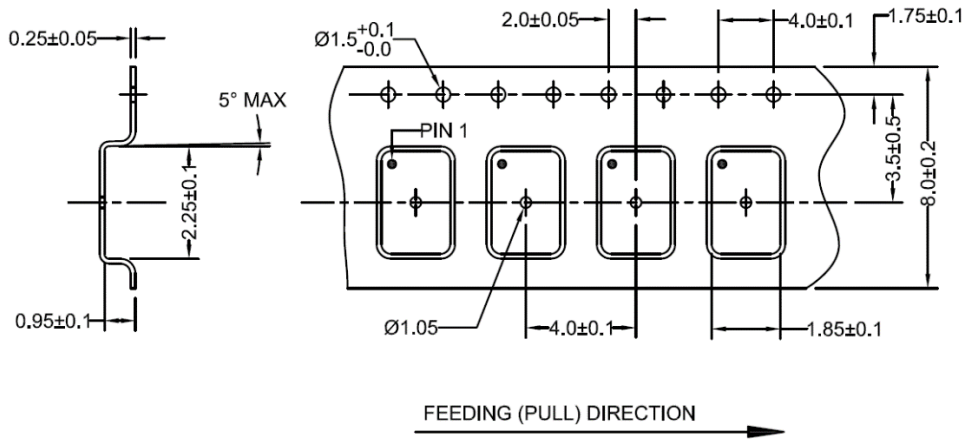

Dimensions: inches (mm)

**ATTENTION:** Abracon LLC's products are COTS – Commercial-Off-The-Shelf products; suitable for Commercial, Industrial and, where designated, Automotive Applications. Abracon's products are not specifically designed for Military, Aviation, Aerospace, Life-dependent Medical applications or any application requiring high reliability where component failure could result in loss of life and/or property. For applications requiring high reliability and/or presenting an extreme operating environment, written consent and authorization from Abracon LLC is required. Please contact Abracon LLC for more information.



5101 Hidden Creek Ln Spicewood TX 78669  
Phone: 512-371-6159 | Fax: 512-351-8858  
For terms and conditions of sales, please visit:  
[www.abracon.com](http://www.abracon.com)

REVISED: 10-26-22

ABRACON IS  
ISO9001-2015  
CERTIFIED