

Xinger®

Delay Line



DESCRIPTION

The XDL15-3-030S can be used in amplifier linearization applications from 135 – 2700Mhz. Small form factor of XDL15-3-030S is ideal for cascading to obtain longer delay. The Xinger® delay lines are a low cost, high quality alternative to the traditional coaxial and filter solutions presently available. Parts have been subjected to rigorous qualification testing and units are 100% tested. Produced with 6 of 6 RoHS compliant tin immersion finish.

Features:

- Production Friendly
- Consistent Delay
- Stable Over Temperature
- Surface Mountable
- Available in Tape & Reel
- Non-Lead Solder Paste Compatible
- Lead Free
- 100% Tested
- MSL 2

ELECTRICAL SPECIFICATIONS*

Frequency (MHz.)	Return Loss (dB) (min)	Insertion Loss per ns (dB/ns) (max)	Group Delay (nS)	Operating Temp. (°C)	Power Handling (Watt)
135-2700	-12	-1.5	2.85 ± 0.30	-55 to +140	1

* Specification based on performance of unit properly installed on Anaren Test Board 66111-0001.
 * Specifications subject to change without notice. Refer to parameter definitions for details.

Mechanical Outline

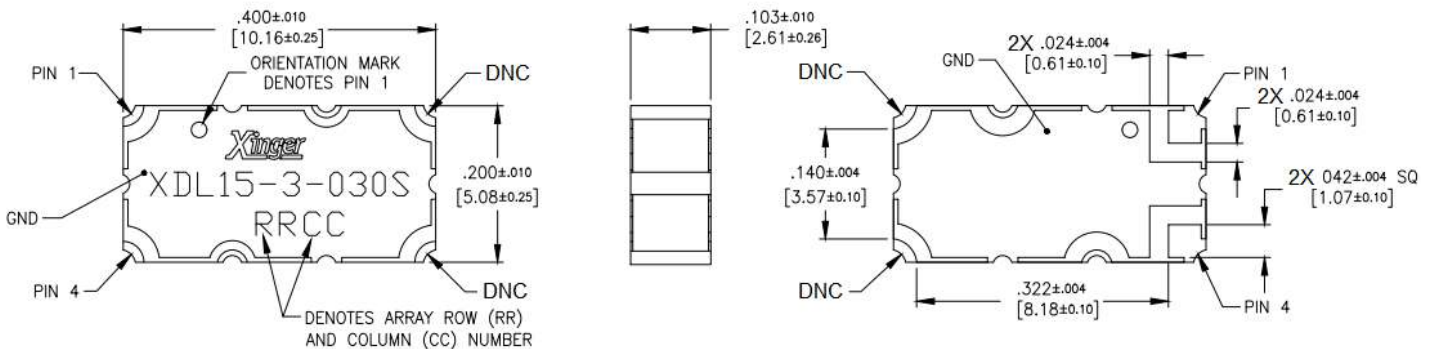

PIN CONFIGURATION

Pin 1	Pin 2	Pin 3	Pin 4
Input	DNC- Do not connect, Do not ground	DNC- Do not connect, Do not ground	Output
Output	DNC- Do not connect, Do not ground	DNC- Do not connect, Do not ground	Input

TYPICAL PERFORMANCE: 100 MHz to 6000 MHz

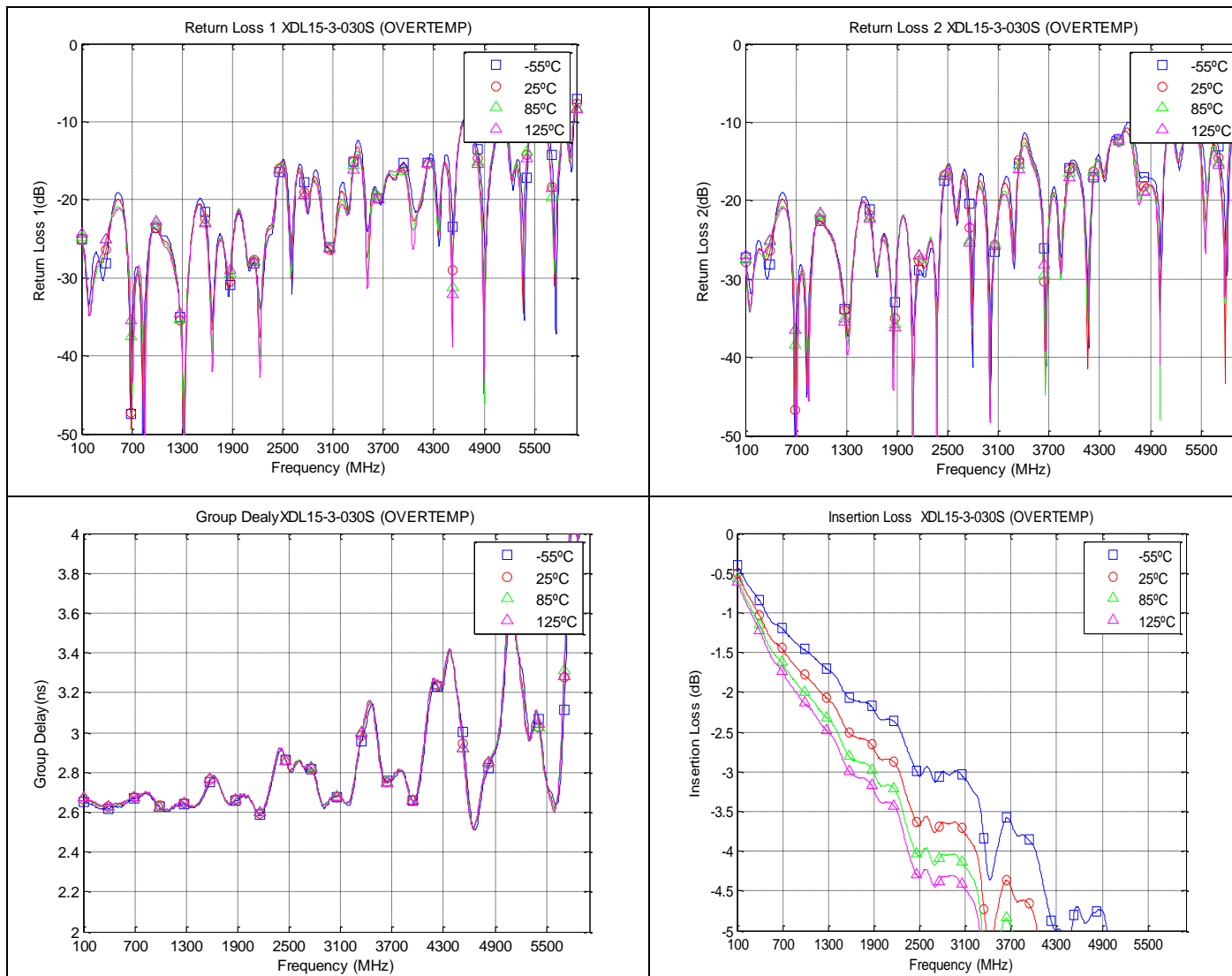

CASCADING XDL15-3-030S

If more than 3ns delay is needed, cascading XDL15-3-030S can provide group delay of 6ns, 9ns and 12ns. Gap of 2mm between the cascaded parts is recommended with solder mask in between.

USA/Canada: (315) 432-8909
 Toll Free: (800) 544-2414
 Europe: +44 2392-232392

Available on Tape and Reel For Pick and Place Manufacturing.



Anaren[®]
 What'll we think of next?®

Mounting

In order for Xinger surface mount delay lines to work optimally, there must be 50Ω transmission lines leading to and from all of the RF ports. Also, there must be a very good ground plane under the part with a number of plated thru holes to ensure proper electrical performance. If any of these conditions are not satisfied, insertion loss, average delay and VSWR may not meet published specifications.

When a surface mount delay line is mounted to a printed circuit board (PCB), the primary concerns are; insuring the RF pads of the device are in contact with the circuit trace of the PCB and the ground plane of neither the component nor the PCB are in contact with the RF signal. An example of how the PCB footprint could look is shown below. In particular designs, the 50Ω lines need to be adjusted to the unique dielectric coefficients and thicknesses as well as varying pick and place equipment tolerances.

Mounting Footprint

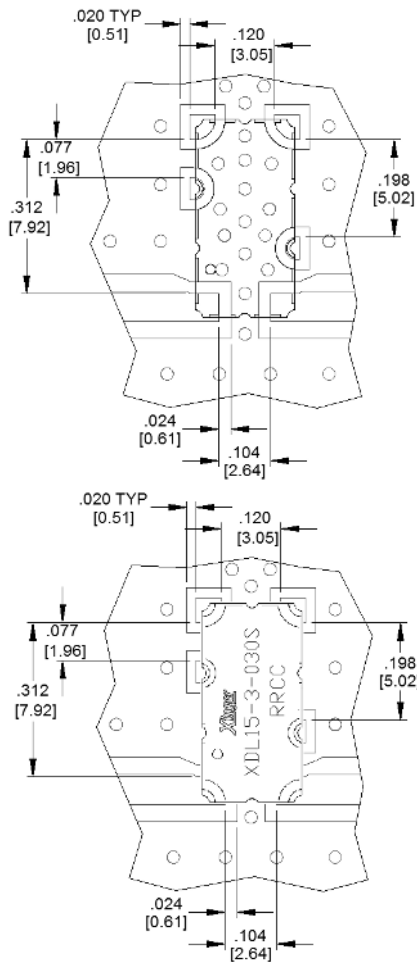

Coupler Mounting Process

The process for assembling this component is a conventional surface mount process as shown in Figure 1. This process is conducive to both low and high volume usage.

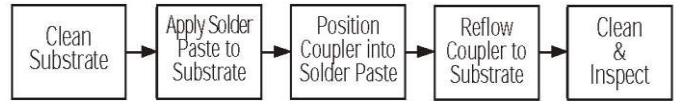

Figure 1: Surface Mounting Process Steps

Storage of Components: The Xinger products are available in immersion tin finish. Commonly used storage procedures used to control oxidation should be followed for these surface mount components. The storage temperatures should be held between 15°C and 60°C.

Substrate: Depending upon the particular component, the circuit material has an x and y coefficient of thermal expansion of between 17 and 25 ppm/°C. This coefficient minimizes solder joint stresses due to similar expansion rates of most commonly used board substrates such as RF35, RO4003, FR4, polyimide and G-10 materials. Mounting to “hard” substrates (alumina etc.) is possible depending upon operational temperature requirements. The solder surfaces of the coupler are all copper plated with either an immersion tin or tin-lead exterior finish.

Solder Paste: All conventional solder paste formulations will work well with Anaren’s Xinger surface mount components. Solder paste can be applied with stencils or syringe dispensers. An example of a stenciled solder paste deposit is shown in Figure 2. As shown in the figure solder paste is applied to the four RF pads and the entire ground plane underneath the body of the part.

Reflow: The surface mount coupler is conducive to most of today’s conventional reflow methods. A low and high temperature thermal reflow profile are shown in Figures 5 and 6, respectively. Manual soldering of these components can be done with conventional surface mount non-contact hot air soldering tools. Board pre-heating is highly recommended for these selective hot air soldering methods. Manual soldering with conventional irons should be avoided.



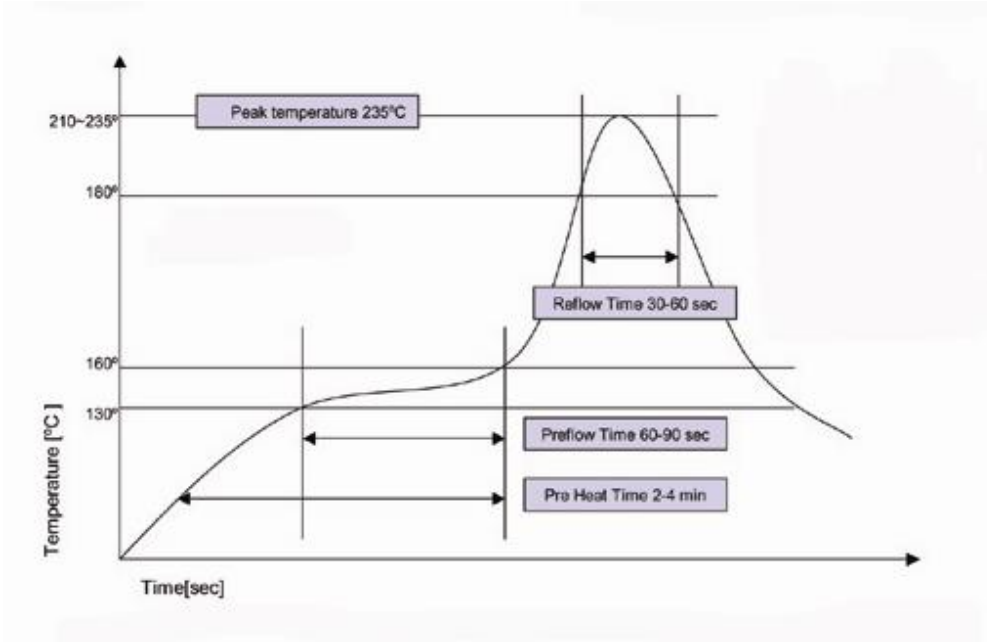

Figure 5 – Low Temperature Solder Reflow Thermal Profile

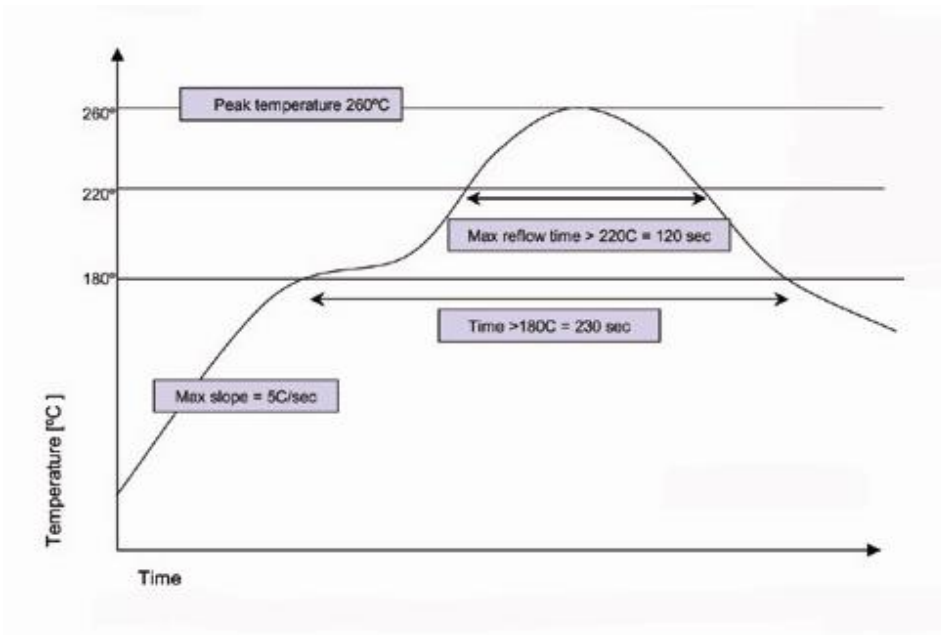
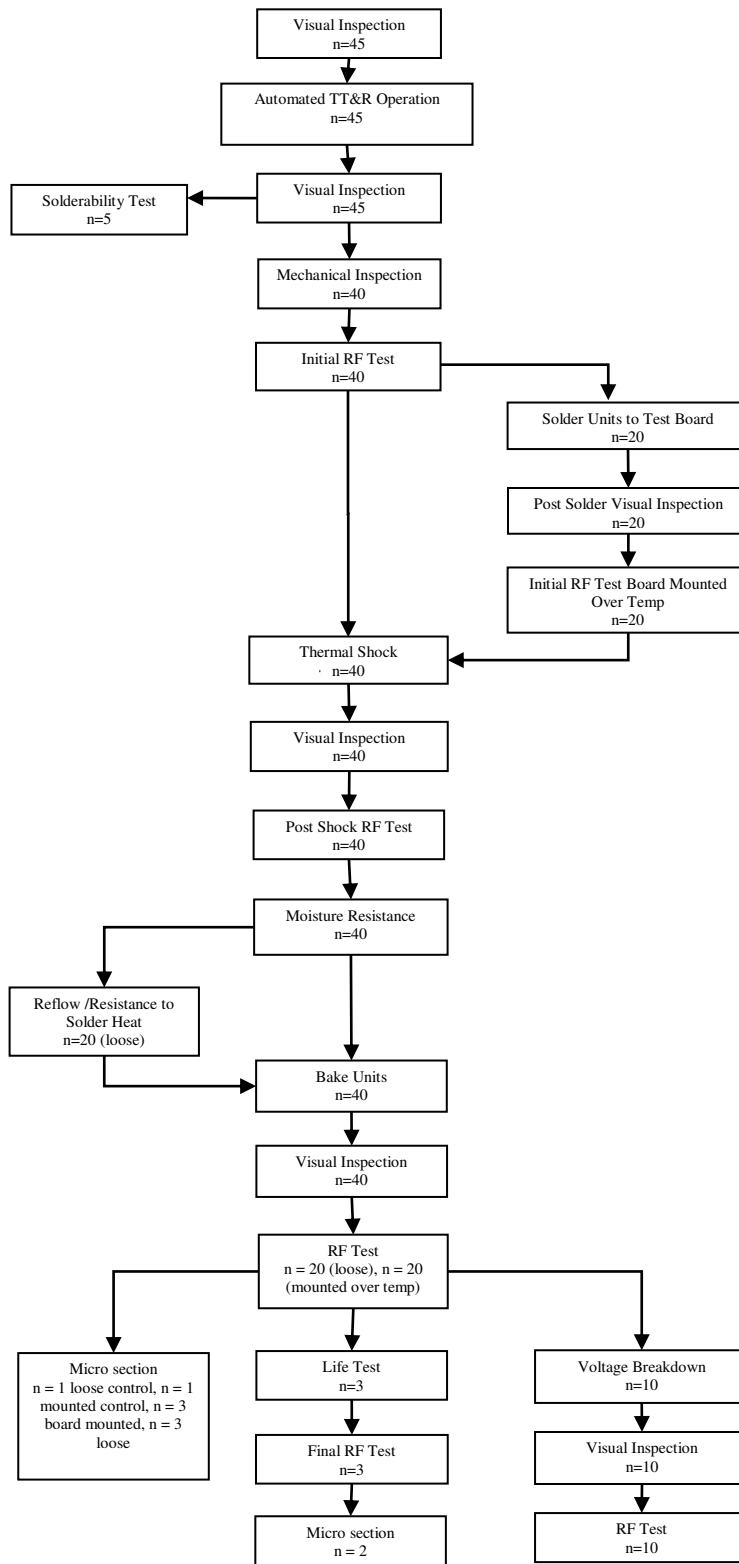

Figure 6 – High Temperature Solder Reflow Thermal Profile



Qualification Flow Chart



Packaging and ordering Information

Parts are available in a reel and as loose parts in a bag. Packaging follows EIA 481-D for reels. Parts are oriented in tape and reel as shown below. Minimum order quantities are 2000 per reel. See Model Numbers below for further ordering information.

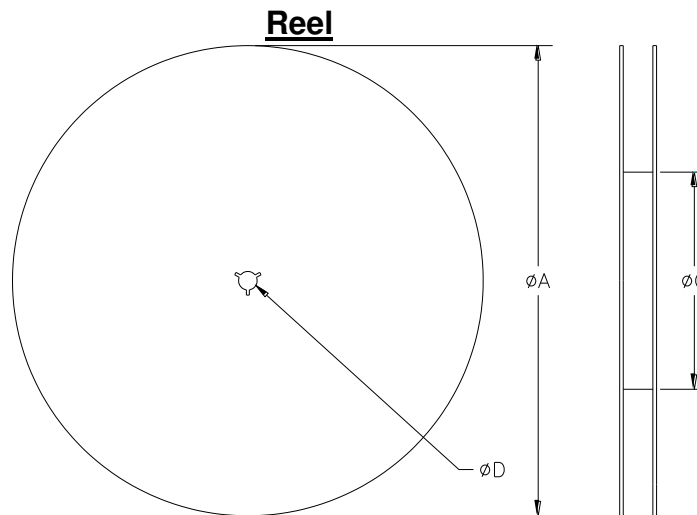
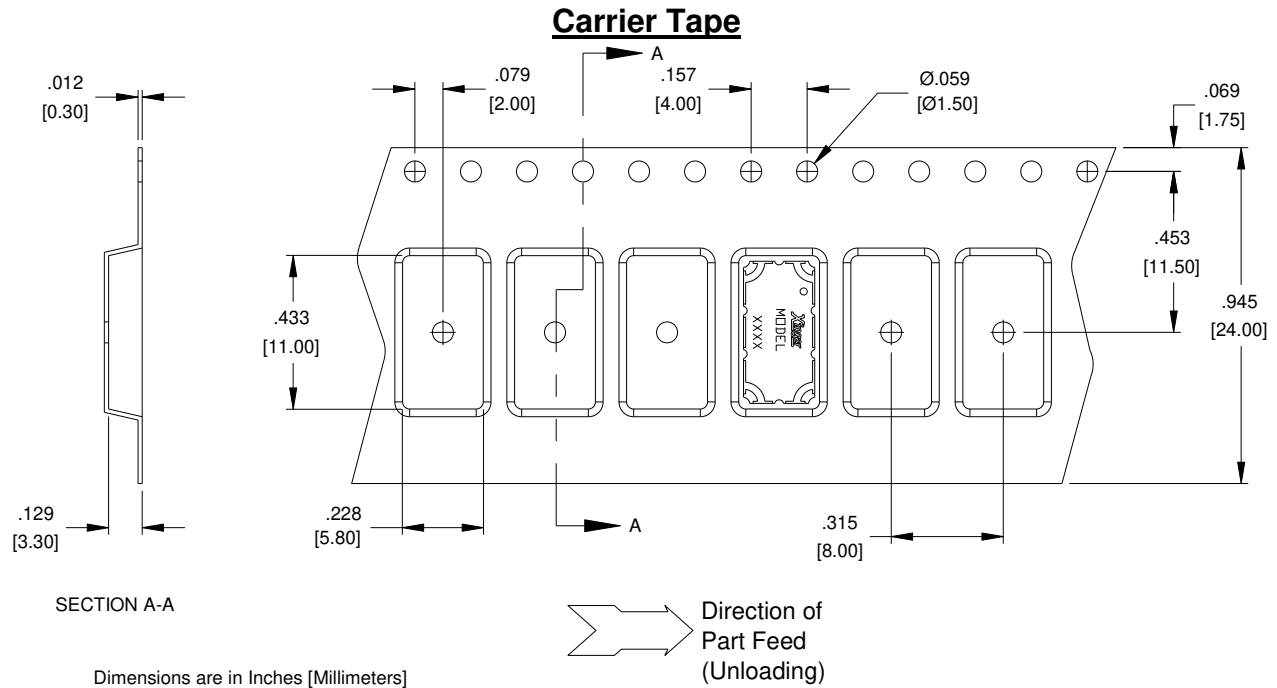

TABLE 1	
REEL DIMENSIONS (inches [mm])	
φA	12.99 [330.0]
B	.945 [24.0]
φC	4.017 [102.03]
φD	0.512 [13.0]

USA/Canada: (315) 432-8909
 Toll Free: (800) 544-2414
 Europe: +44 2392-232392

Available on Tape and Reel For Pick and Place Manufacturing.



Anaren[®]
 What'll we think of next?®