



# BIPOLAR ANALOG INTEGRATED CIRCUIT

## $\mu$ PC2745TB, $\mu$ PC2746TB

### 3 V, SUPER MINIMOLD SILICON MMIC WIDEBAND AMPLIFIER FOR MOBILE COMMUNICATIONS

#### DESCRIPTION

The  $\mu$ PC2745TB and  $\mu$ PC2746TB are silicon monolithic integrated circuits designed as buffer amplifier for mobile communications. These low current amplifiers operate on 3.0 V (1.8 V MIN.).

These ICs are manufactured using our 20 GHz fr NESATIII silicon bipolar process. This process uses silicon nitride passivation film and gold electrodes. These materials can protect chip surface from external pollution and prevent corrosion/migration. Thus, these IC have excellent performance, uniformity and reliability.

#### FEATURES

- Supply voltage : Recommended  $V_{CC} = 2.7$  to  $3.3$  V  
Circuit operation  $V_{CC} = 1.8$  to  $3.3$  V
- Upper limit operating frequency :  $\mu$ PC2745TB;  $f_u = 2.7$  GHz TYP. @3 dB bandwidth  
 $\mu$ PC2746TB;  $f_u = 1.5$  GHz TYP. @3 dB bandwidth
- High isolation :  $\mu$ PC2745TB; ISL = 38 dB TYP. @f = 500 MHz  
 $\mu$ PC2746TB; ISL = 45 dB TYP. @f = 500 MHz
- Power gain :  $\mu$ PC2745TB;  $G_P = 12$  dB TYP. @f = 500 MHz  
 $\mu$ PC2746TB;  $G_P = 19$  dB TYP. @f = 500 MHz
- Saturated output power :  $\mu$ PC2745TB;  $P_{O(sat)} = -1$  dBm TYP. @f = 500 MHz  
 $\mu$ PC2746TB;  $P_{O(sat)} = 0$  dBm TYP. @f = 500 MHz
- High-density surface mounting : 6-pin super minimold package ( $2.0 \times 1.25 \times 0.9$  mm)

#### APPLICATIONS

- 1.5 GHz to 2.5 GHz communication system :  $\mu$ PC2745TB
- 800 MHz to 900 MHz communication system :  $\mu$ PC2746TB

#### ORDERING INFORMATION

Part Number	Package	Marking	Supplying Form
$\mu$ PC2745TB-E3-A	6-pin super minimold	C1Q	• Embossed tape 8 mm wide • 1, 2, 3 pins face the perforation side of the tape • Qty 3 kpcs/reel
$\mu$ PC2746TB-E3-A		C1R	

**Remark** To order evaluation samples, contact your nearby sales office.  
Part number for sample order:  $\mu$ PC2745TB-A,  $\mu$ PC2746TB-A

**Caution: Observe precautions when handling because these devices are sensitive to electrostatic discharge.**

The information in this document is subject to change without notice. Before using this document, please confirm that this is the latest version.

**PIN CONNECTION**

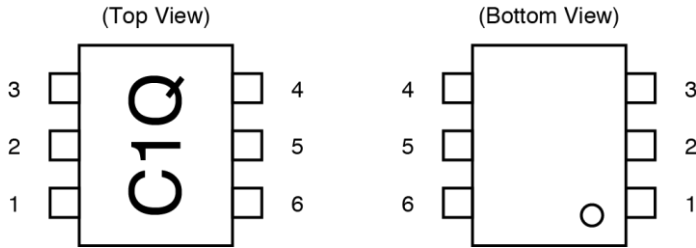

Marking is an example of  $\mu$ PC2745TB

Pin No.	Pin Name
1	INPUT
2	GND
3	GND
4	OUTPUT
5	GND
6	V <sub>cc</sub>

**PRODUCT LINE-UP (T<sub>A</sub> = +25°C, V<sub>cc</sub> = 3.0 V, Z<sub>s</sub> = Z<sub>L</sub> = 50 Ω)**

Part No.	f <sub>u</sub> (GHz)	P <sub>O(sat)</sub> (dBm)	G <sub>P</sub> (dB)	NF (dB)	I <sub>cc</sub> (mA)	Package	Making
$\mu$ PC2745T	2.7	-1.0	12	6.0	7.5	6-pin minimold	C1Q
$\mu$ PC2745TB						6-pin super minimold	
$\mu$ PC2746T	1.5	0	19	4.0	7.5	6-pin minimold	C1R
$\mu$ PC2746TB						6-pin super minimold	
$\mu$ PC2747T	1.8	-7.0	12	3.3	5.0	6-pin minimold	C1S
$\mu$ PC2747TB						6-pin super minimold	
$\mu$ PC2748T	0.2 to 1.5	-3.5	19	2.8	6.0	6-pin minimold	C1T
$\mu$ PC2748TB						6-pin super minimold	
$\mu$ PC2749T	2.9	-6.0	16	4.0	6.0	6-pin minimold	C1U
$\mu$ PC2749TB						6-pin super minimold	

**Remark** Typical performance. Please refer to **ELECTRICAL CHARACTERISTICS** in detail.

**Caution** The package size distinguish between minimold and super minimold.

**SYSTEM APPLICATION EXAMPLE**

**DIGITAL CELLULAR SYSTEM BLOCK DIAGRAM**

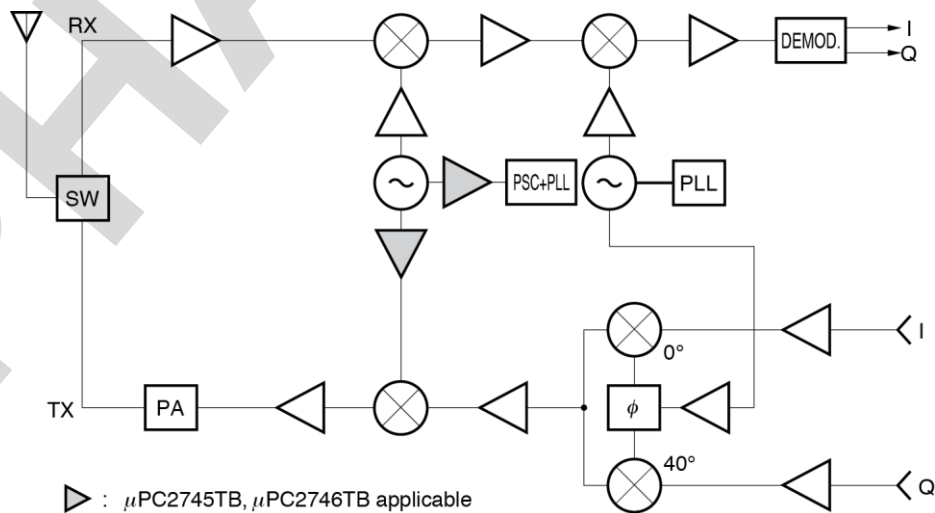

**PIN EXPLANATION**

Pin No.	Pin Name	Applied Voltage (V)	Pin Voltage (V) <small>Note</small>	Function and Applications	Internal Equivalent Circuit
1	INPUT	—	0.87 ----- 0.82	Signal input pin. A internal matching circuit, configured with resistors, enables 50 $\Omega$ connection over a wide band. this pin must be coupled to signal source with capacitor for DC cut.	
2 3 5	GND	0	—	Ground pin. This pin should be connected to system ground with minimum inductance. Ground pattern on the board should be formed as wide as possible. All the ground pins must be connected together with wide ground pattern to decrease impedance difference.	
4	OUTPUT	—	1.95 ----- 2.54	Signal output pin. A internal matching circuit, configured with resistors, enables 50 $\Omega$ connection over a wide band. This pin must be coupled to next stage with capacitor for DC cut.	
6	V <sub>cc</sub>	2.7 to 3.3	—	Power supply pin. This pin should be externally equipped with bypass capacity to minimize ground impedance.	

**Note** Pin voltage is measured at V<sub>cc</sub> = 3.0 V. Above:  $\mu$ PC2745TB, Below:  $\mu$ PC2746TB

**ABSOLUTE MAXIMUM RATINGS**

Parameter	Symbol	Conditions	Ratings	Unit
Supply Voltage	V <sub>CC</sub>	T <sub>A</sub> = +25°C	4.0	V
Circuit Current	I <sub>CC</sub>	T <sub>A</sub> = +25°C	16	mA
Power Dissipation	P <sub>D</sub>	T <sub>A</sub> = +85°C <b>Note</b>	270	mW
Operating Ambient Temperature	T <sub>A</sub>		-40 to +85	°C
Storage Temperature	T <sub>stg</sub>		-55 to +150	°C
Input Power	P <sub>in</sub>	T <sub>A</sub> = +25°C	0	dBm

**Note** Mounted on double-sided copper-clad 50 × 50 × 1.6 mm epoxy glass PWB

**RECOMMENDED OPERATING RANGE**

Parameter	Symbol	MIN.	TYP.	MAX.	Unit
Supply Voltage	V <sub>CC</sub>	2.7	3.0	3.3	V

**ELECTRICAL CHARACTERISTICS**

(T<sub>A</sub> = +25°C, V<sub>CC</sub> = 3.0 V, Z<sub>S</sub> = Z<sub>L</sub> = 50 Ω, unless otherwise specified)

Parameter	Symbol	Test Conditions	$\mu$ PC2745TB			$\mu$ PC2746TB			Unit
			MIN.	TYP.	MAX.	MIN.	TYP.	MAX.	
Circuit Current	I <sub>CC</sub>	No signal	5.0	7.5	10.0	5.0	7.5	10.0	mA
Power Gain	G <sub>P</sub>	f = 500 MHz	9	12	14	16	19	21	dB
Noise Figure	NF	f = 500 MHz	—	6.0	7.5	—	4.0	5.5	dB
Upper Limit Operating Frequency	f <sub>u</sub>	3 dB down below from gain at f = 0.1 GHz	2.3	2.7	—	1.1	1.5	—	GHz
Isolation	ISL	f = 500 MHz	33	38	—	40	45	—	dB
Input Return Loss	RL <sub>in</sub>	f = 500 MHz	8	11	—	10	13	—	dB
Output Return Loss	RL <sub>out</sub>	f = 500 MHz	2.5	5.5	—	5.5	8.5	—	dB
Saturated Output Power	P <sub>O(sat)</sub>	f = 500 MHz, P <sub>in</sub> = -6 dBm	-4.0	-1.0	—	-3.0	0	—	dBm

STANDARD CHARACTERISTICS FOR REFERENCE ( $T_A = +25^\circ\text{C}$ ,  $V_{CC} = 3.0\text{ V}$ ,  $Z_S = Z_L = 50\ \Omega$ )

Parameter	Symbol	Test Conditions	Reference Value		Unit
			$\mu$ PC2745TB	$\mu$ PC2746TB	
Circuit Current	$I_{CC}$	$V_{CC} = 1.8\text{ V}$ , No signal	4.5	4.5	mA
Power Gain	$G_P$	$V_{CC} = 3.0\text{ V}$ , $f = 1.0\text{ GHz}$	12.0	18.5	dB
		$V_{CC} = 3.0\text{ V}$ , $f = 2.0\text{ GHz}$	11.0	—	
		$V_{CC} = 1.8\text{ V}$ , $f = 0.5\text{ GHz}$	7.0	14.0	
Noise Figure	NF	$V_{CC} = 3.0\text{ V}$ , $f = 1.0\text{ GHz}$	5.5	4.2	dB
		$V_{CC} = 3.0\text{ V}$ , $f = 2.0\text{ GHz}$	5.7	—	
		$V_{CC} = 1.8\text{ V}$ , $f = 0.5\text{ GHz}$	8.0	5.0	
Upper Limit Operating Frequency	$f_u$	$V_{CC} = 1.8\text{ V}$ , 3 dB down below from gain at $f = 0.1\text{ GHz}$	1.8	1.1	GHz
Isolation	ISL	$V_{CC} = 3.0\text{ V}$ , $f = 1.0\text{ GHz}$	33	38	dB
		$V_{CC} = 3.0\text{ V}$ , $f = 2.0\text{ GHz}$	30	—	
		$V_{CC} = 1.8\text{ V}$ , $f = 0.5\text{ GHz}$	35	37	
Input Return Loss	$RL_{in}$	$V_{CC} = 3.0\text{ V}$ , $f = 1.0\text{ GHz}$	13.0	10.0	dB
		$V_{CC} = 3.0\text{ V}$ , $f = 2.0\text{ GHz}$	14.0	—	
		$V_{CC} = 1.8\text{ V}$ , $f = 0.5\text{ GHz}$	6.5	10.0	
Output Return Loss	$RL_{out}$	$V_{CC} = 3.0\text{ V}$ , $f = 1.0\text{ GHz}$	6.5	8.5	dB
		$V_{CC} = 3.0\text{ V}$ , $f = 2.0\text{ GHz}$	8.5	—	
		$V_{CC} = 1.8\text{ V}$ , $f = 0.5\text{ GHz}$	6.0	9.5	
Saturated Output Power	$P_{O(sat)}$	$V_{CC} = 3.0\text{ V}$ , $f = 1.0\text{ GHz}$ , $P_{in} = -6\text{ dBm}$	-2.5	-1.0	dBm
		$V_{CC} = 3.0\text{ V}$ , $f = 2.0\text{ GHz}$ , $P_{in} = -6\text{ dBm}$	-3.5	—	
		$V_{CC} = 1.8\text{ V}$ , $f = 0.5\text{ GHz}$ , $P_{in} = -10\text{ dBm}$	-11.0	-8.0	
3rd Order Intermodulation Distortion	IM <sub>3</sub>	$V_{CC} = 3.0\text{ V}$ , $P_{out} = -10\text{ dBm}$ , $f_1 = 500\text{ MHz}$ , $f_2 = 502\text{ MHz}$	-30.0	-26.0	dBc
		$V_{CC} = 1.8\text{ V}$ , $P_{out} = -20\text{ dBm}$ , $f_1 = 500\text{ MHz}$ , $f_2 = 502\text{ MHz}$	-31.0	-37.0	
		$V_{CC} = 3.0\text{ V}$ , $P_{out} = -10\text{ dBm}$ , $f_1 = 1\ 000\text{ MHz}$ , $f_2 = 1\ 002\text{ MHz}$	-26.0	—	



**TEST CIRCUIT**

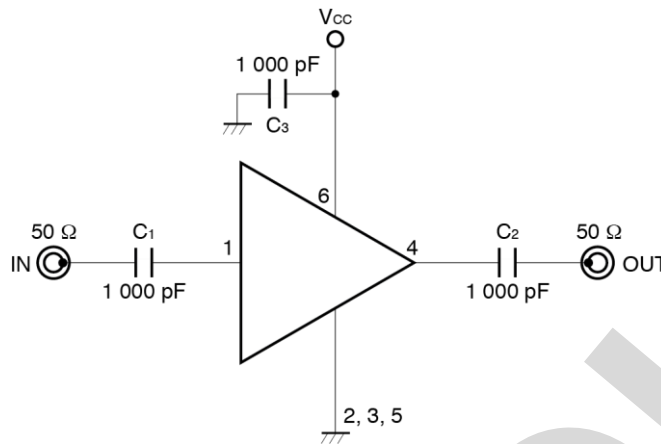

**EXAMPLE OF APPLICATION CIRCUIT**

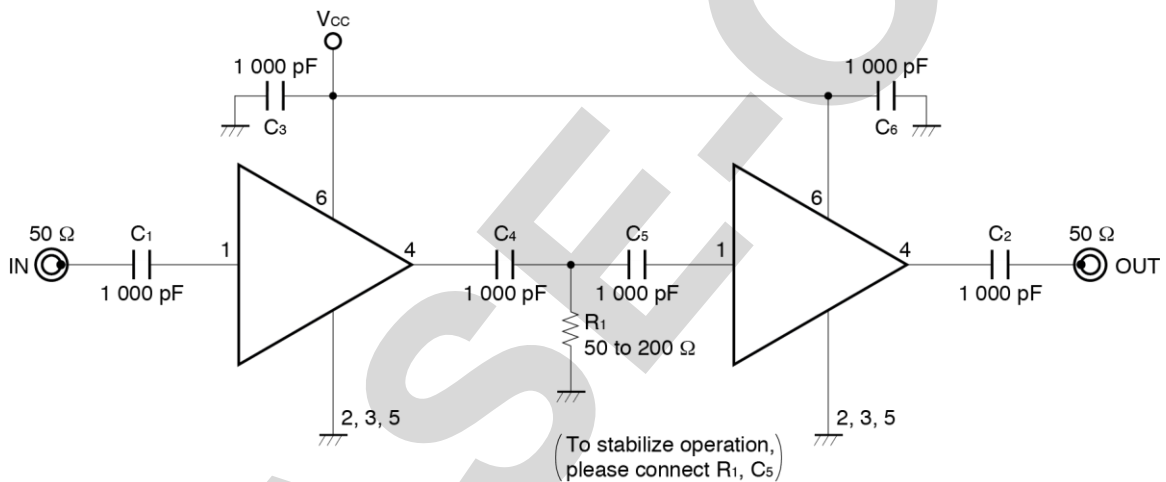

The application circuits and their parameters are for references only and are not intended for use in actual design-ins.

**CAPACITORS FOR THE V<sub>CC</sub>, INPUT, AND OUTPUT PINS**

Capacitors of 1 000 pF are recommendable as the bypass capacitor for the V<sub>CC</sub> pin and the coupling capacitors for the input and output pins.

The bypass capacitor connected to the V<sub>CC</sub> pin is used to minimize ground impedance of V<sub>CC</sub> pin. So, stable bias can be supplied against V<sub>CC</sub> fluctuation.

The coupling capacitors, connected to the input and output pins, are used to cut the DC and minimize RF serial impedance. Their capacitance are therefore selected as lower impedance against a 50 Ω load. The capacitors thus perform as high pass filters, suppressing low frequencies to DC.

To obtain a flat gain from 100 MHz upwards, 1 000 pF capacitors are used in the test circuit. In the case of under 10 MHz operation, increase the value of coupling capacitor such as 10 000 pF. Because the coupling capacitors are determined by equation,  $f_c = 1/(2\pi RC)$ .

ILLUSTRATION OF THE TEST CIRCUIT ASSEMBLED ON EVALUATION BOARD

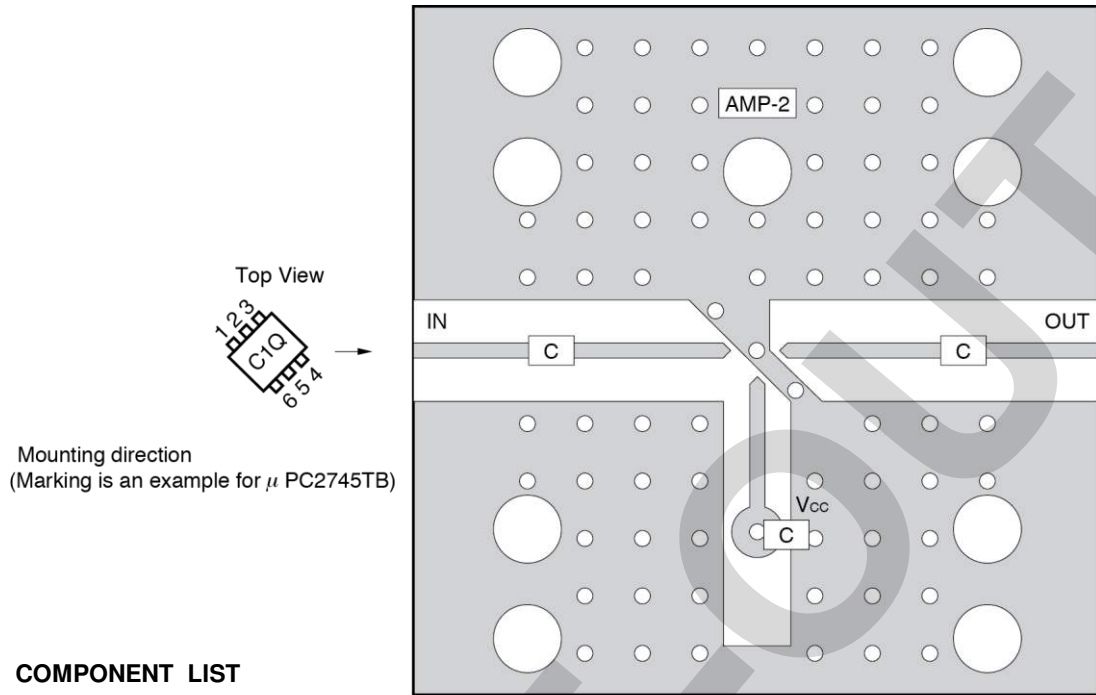

COMPONENT LIST

	Value
C	1 000 pF

Notes

1. 30 × 30 × 0.4 mm double sided copper clad polyimide board.
2. Back side: GND pattern
3. Solder plated on pattern
4.  $\oplus \oplus \oplus$ : Through holes

For more information on the use of this IC, refer to the following application note: **USAGE AND APPLICATIONS OF 6-PIN MINI-MOLD, 6-PIN SUPER MINI-MOLD SILICON HIGH-FREQUENCY WIDEBAND AMPLIFIER MMIC (P11976E).**

**TYPICAL CHARACTERISTICS** ( $T_A = +25^\circ\text{C}$ , unless otherwise specified)

—  $\mu$ PC2745TB —

CIRCUIT CURRENT vs. SUPPLY VOLTAGE

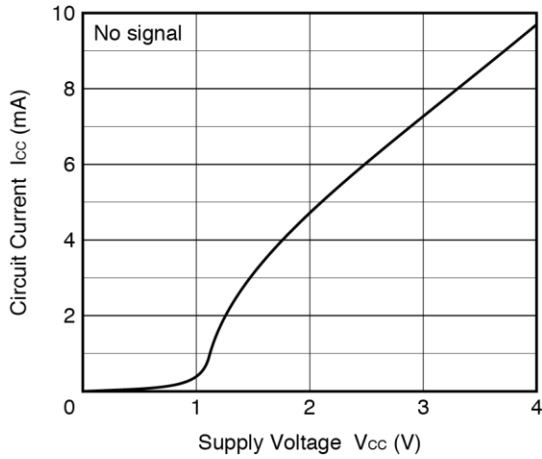

CIRCUIT CURRENT vs. OPERATING AMBIENT TEMPERATURE

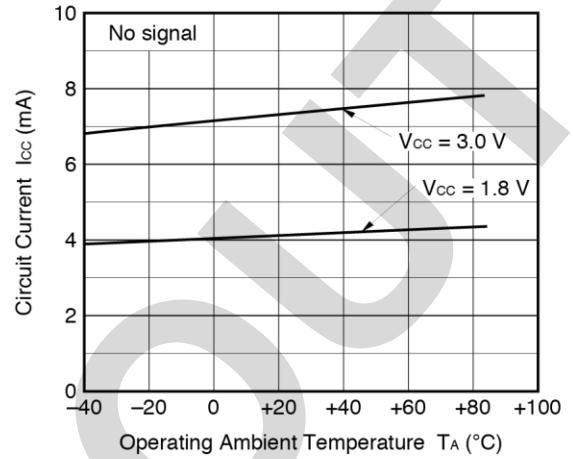

NOISE FIGURE, POWER GAIN vs. FREQUENCY

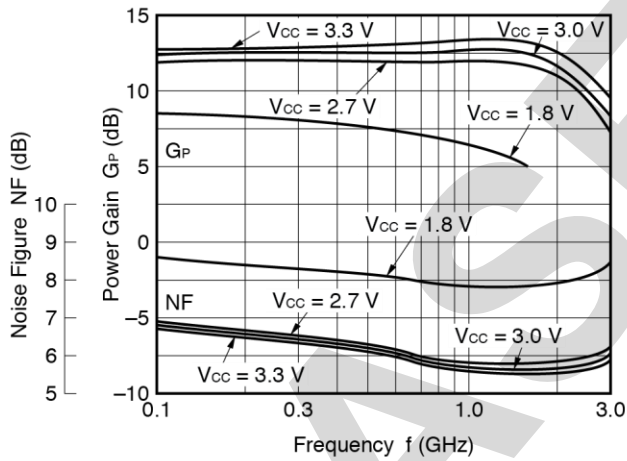

POWER GAIN vs. FREQUENCY

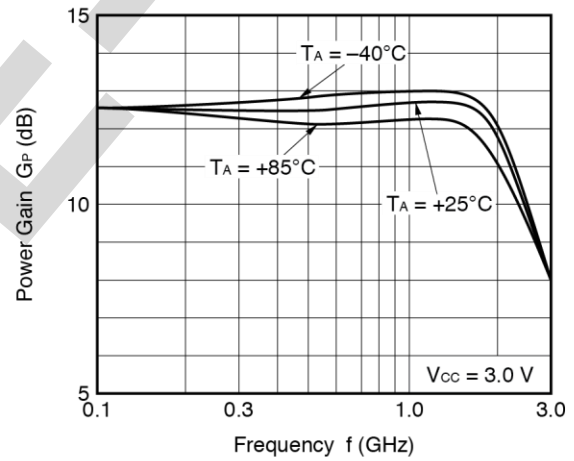

ISOLATION vs. FREQUENCY

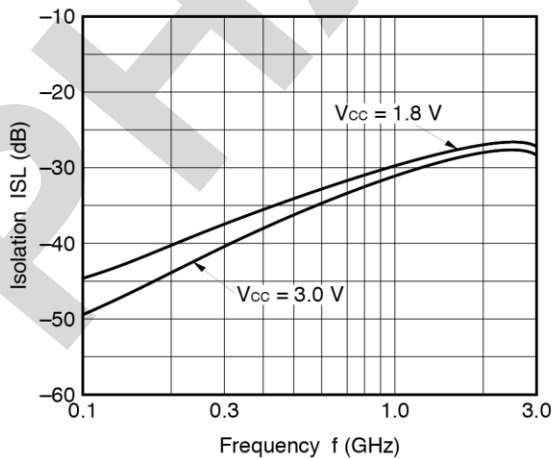

INPUT RETURN LOSS, OUTPUT RETURN LOSS vs. FREQUENCY

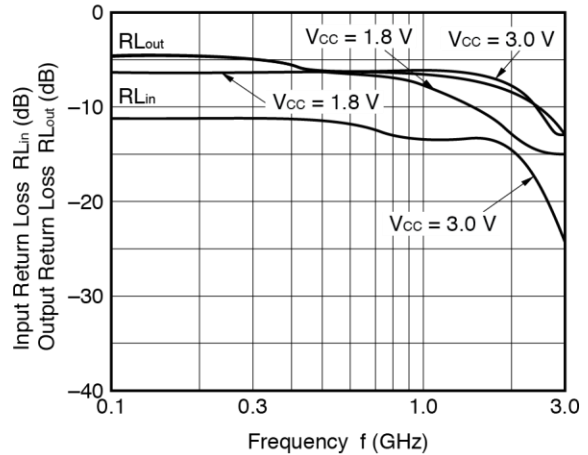

**Remark** The graphs indicate nominal characteristics.



—  $\mu$ PC2745TB —

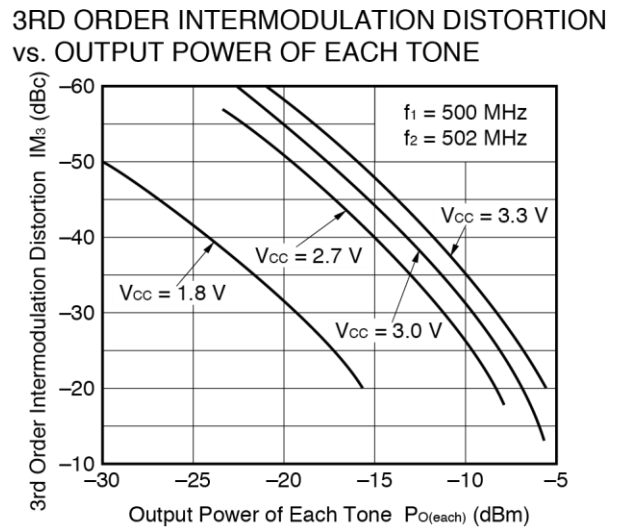
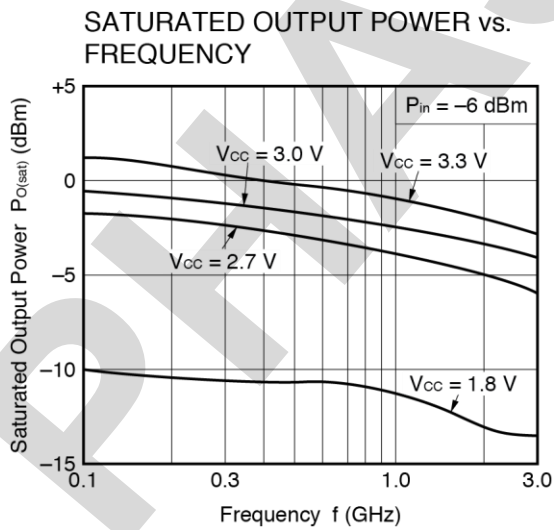
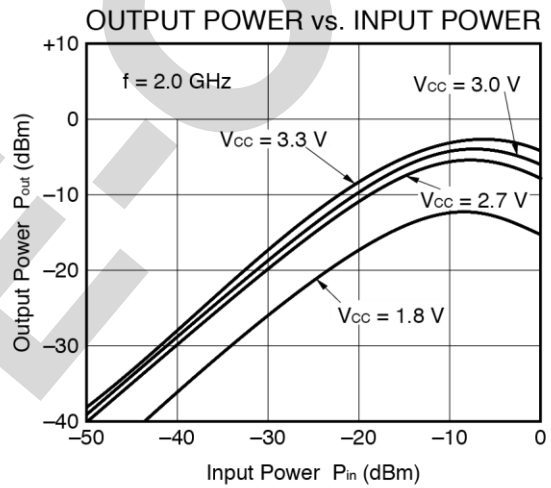
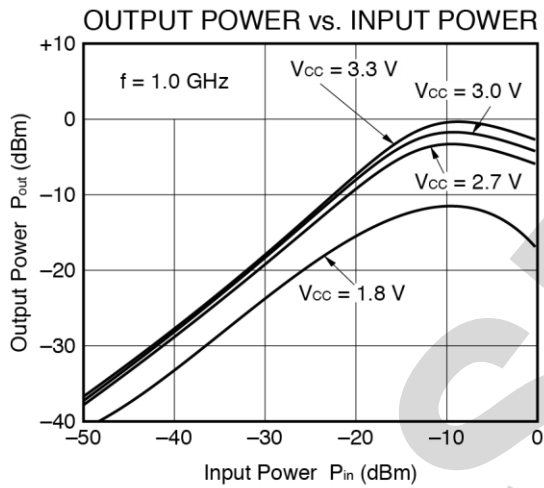
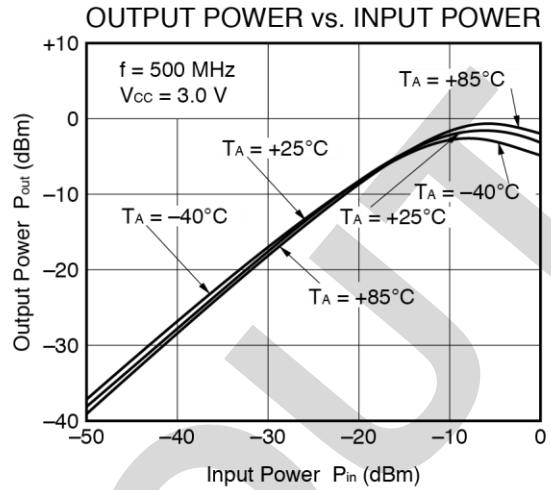
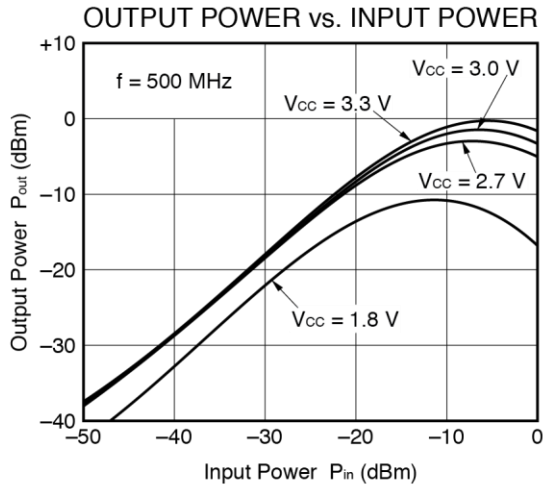

**Remark** The graphs indicate nominal characteristics.

SMITH CHART ( $T_A = +25^\circ\text{C}$ ,  $V_{CC} = 3.0\text{ V}$ )

—  $\mu$ PC2745TB —

S<sub>11</sub>-FREQUENCY

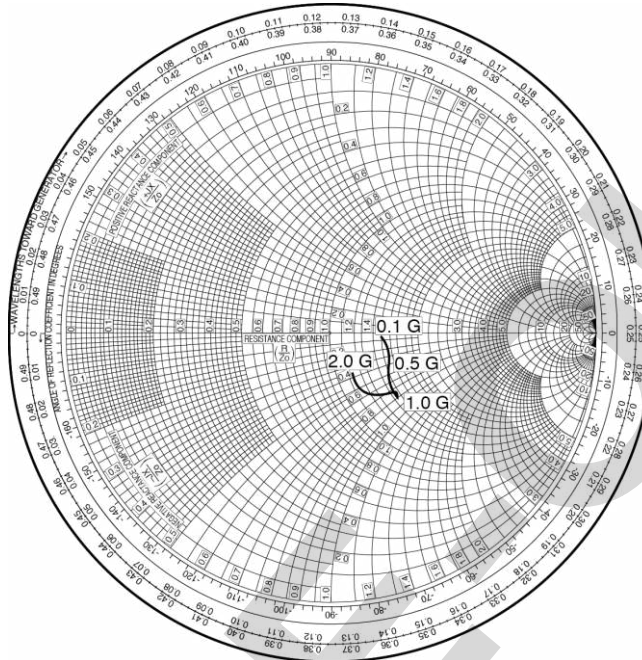

S<sub>22</sub>-FREQUENCY

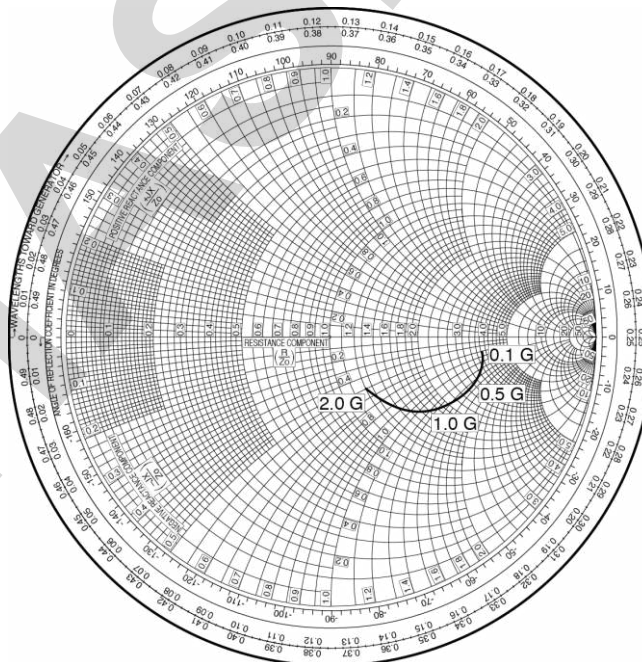

**S-PARAMETERS**

- S-parameters and noise parameters are provided on our Web site in a format (S2P) that enables the direct import of the parameters to microwave circuit simulators without the need for keyboard inputs.
- [Click here to download S-parameters.](#)
- [RF and Microwave] ® [Device Parameters]
- URL <http://www.necel.com/microwave/en/>

PHASE-OUT

**TYPICAL CHARACTERISTICS ( $T_A = +25^\circ\text{C}$ , unless otherwise specified)**

—  $\mu$ PC2746TB —

CIRCUIT CURRENT vs. SUPPLY VOLTAGE

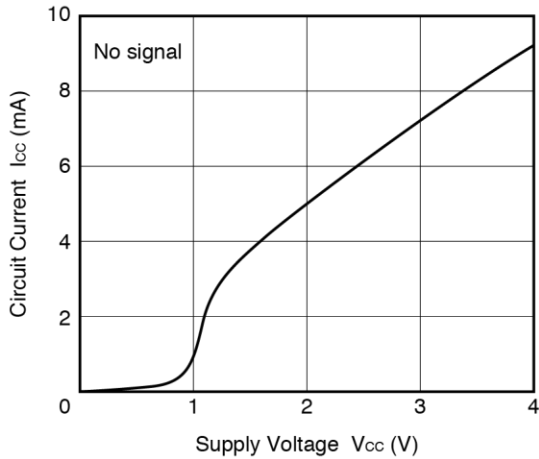

CIRCUIT CURRENT vs. OPERATING AMBIENT TEMPERATURE

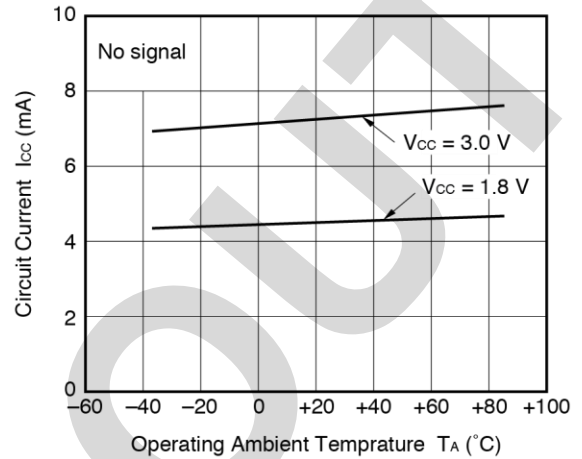

NOISE FIGURE, POWER GAIN vs. FREQUENCY

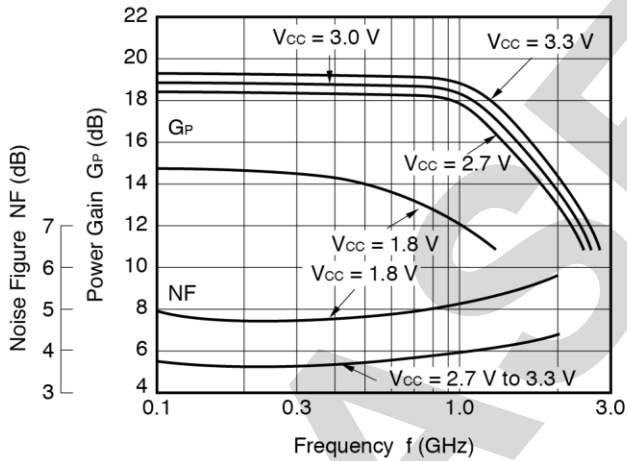

POWER GAIN vs. FREQUENCY

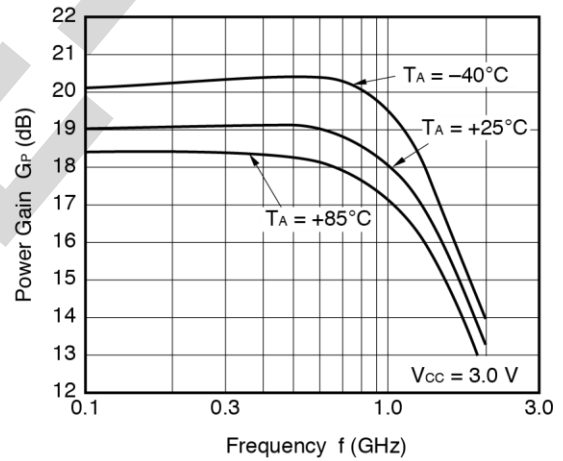

ISOLATION vs. FREQUENCY

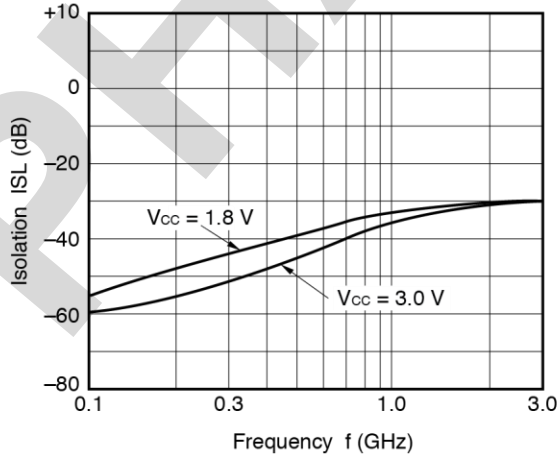

INPUT RETURN LOSS, OUTPUT RETURN LOSS vs. FREQUENCY

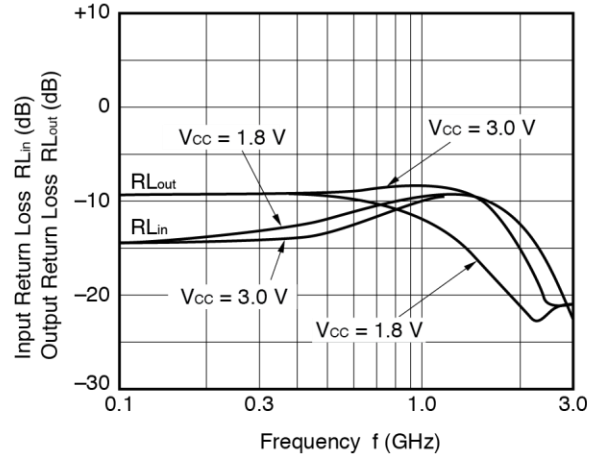

**Remark** The graphs indicate nominal characteristics.

—  $\mu$ PC2746TB —

OUTPUT POWER vs. INPUT POWER

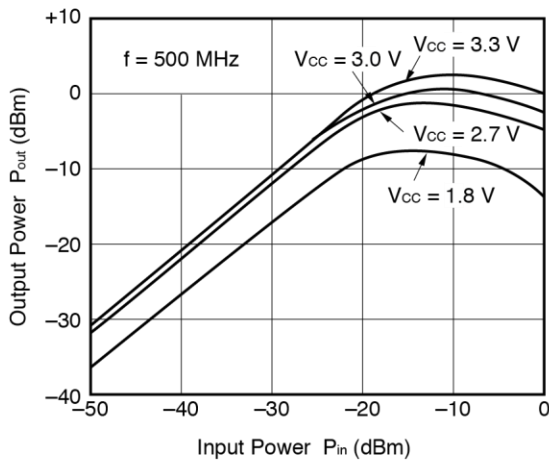

OUTPUT POWER vs. INPUT POWER

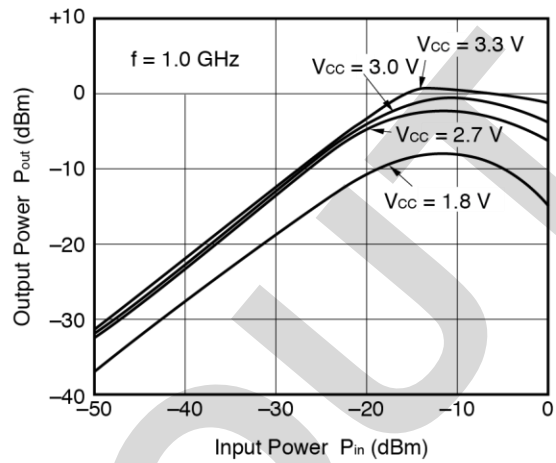

OUTPUT POWER vs. INPUT POWER

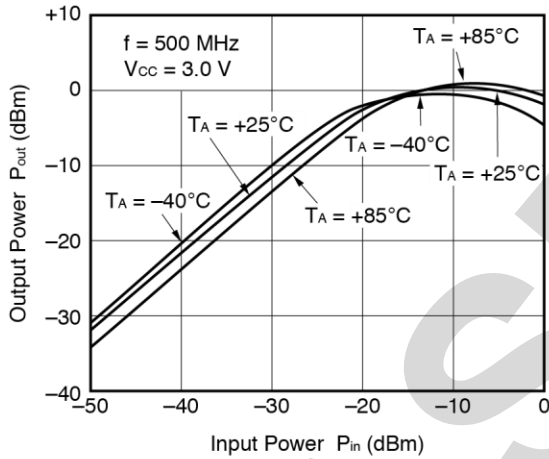

OUTPUT POWER vs. INPUT POWER

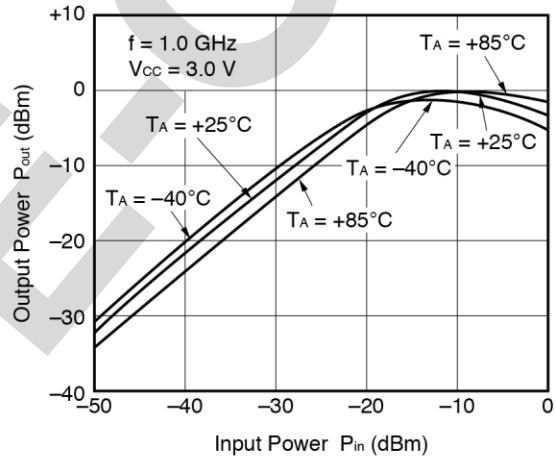

SATURATED OUTPUT POWER vs. FREQUENCY

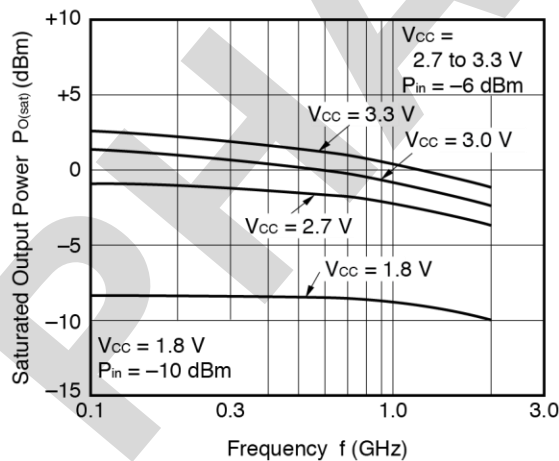

3RD ORDER INTERMODULATION DISTORTION vs. OUTPUT POWER OF EACH TONE

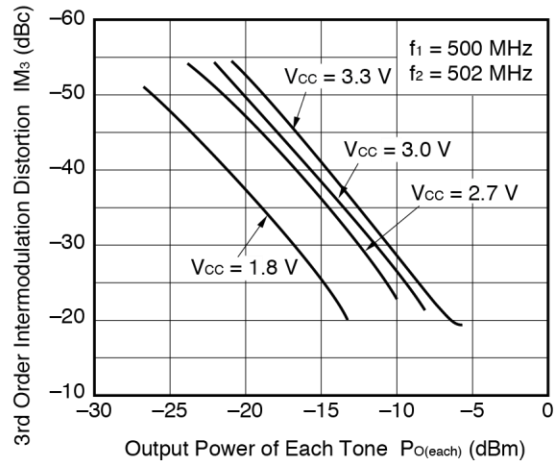

**Remark** The graphs indicate nominal characteristics.

SMITH CHART ( $T_A = +25^\circ\text{C}$ ,  $V_{CC} = 3.0\text{ V}$ )

—  $\mu$ PC2746TB —

S<sub>11</sub>-FREQUENCY

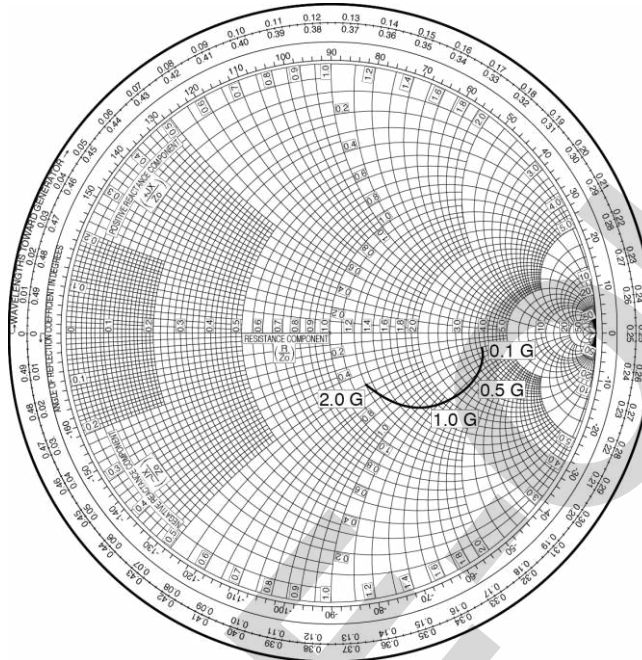

S<sub>22</sub>-FREQUENCY

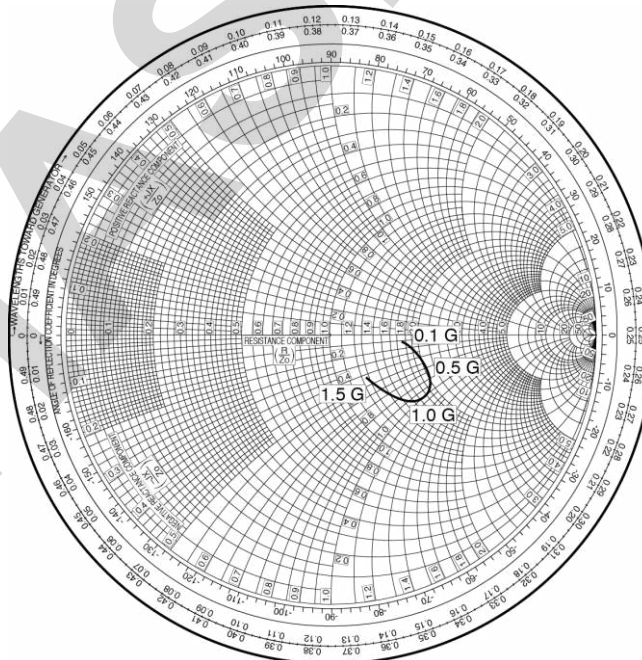

**S-PARAMETERS**

- S-parameters and noise parameters are provided on our Web site in a format (S2P) that enables the direct import of the parameters to microwave circuit simulators without the need for keyboard inputs.
- [Click here to download S-parameters.](#)
- [RF and Microwave] ® [Device Parameters]
- URL <http://www.necel.com/microwave/en/>

PHASE-OUT

PACKAGE DIMENSIONS

6-PIN SUPER MINIMOLD (UNIT: mm)

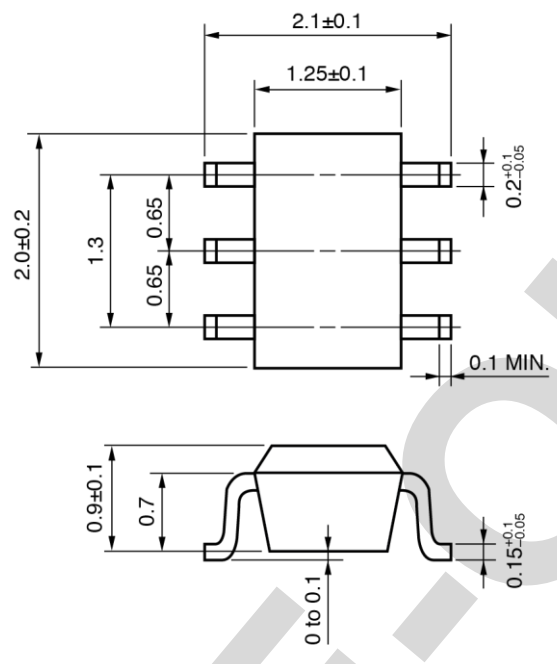

PHASE OUT



**NOTES ON CORRECT USE**

- (1) Observe precautions for handling because of electro-static sensitive devices.
- (2) Form a ground pattern as widely as possible to minimize ground impedance (to prevent undesired oscillation).  
All the ground pins must be connected together with wide ground pattern to decrease impedance difference.
- (3) The bypass capacitor should be attached to the Vcc pin.
- (4) The DC cut capacitor must be attached to input pin and output pin.

**RECOMMENDED SOLDERING CONDITIONS**

This product should be soldered and mounted under the following recommended conditions. For soldering methods and conditions other than those recommended below, contact your nearby sales office.

Soldering Method	Soldering Conditions	Condition Symbol
Infrared Reflow	Peak temperature (package surface temperature) : 260°C or below Time at peak temperature : 10 seconds or less Time at temperature of 220°C or higher : 60 seconds or less Preheating time at 120 to 180°C : 120±30 seconds Maximum number of reflow processes : 3 times Maximum chlorine content of rosin flux (% mass) : 0.2%(Wt.) or below	IR260
VPS	Peak temperature (package surface temperature) : 215°C or below Time at temperature of 200°C or higher : 25 to 40 seconds Preheating time at 120 to 150°C : 30 to 60 seconds Maximum number of reflow processes : 3 times Maximum chlorine content of rosin flux (% mass) : 0.2%(Wt.) or below	VP215
Wave Soldering	Peak temperature (molten solder temperature) : 260°C or below Time at peak temperature : 10 seconds or less Preheating temperature (package surface temperature) : 120°C or below Maximum number of flow processes : 1 time Maximum chlorine content of rosin flux (% mass) : 0.2%(Wt.) or below	WS260
Partial Heating	Peak temperature (pin temperature) : 350°C or below Soldering time (per side of device) : 3 seconds or less Maximum chlorine content of rosin flux (% mass) : 0.2%(Wt.) or below	HS350

**Caution Do not use different soldering methods together (except for partial heating).**

## NOTICE

1. Descriptions of circuits, software and other related information in this document are provided only to illustrate the operation of semiconductor products and application examples. You are fully responsible for the incorporation of these circuits, software, and information in the design of your equipment. California Eastern Laboratories and Renesas Electronics assumes no responsibility for any losses incurred by you or third parties arising from the use of these circuits, software, or information.
2. California Eastern Laboratories has used reasonable care in preparing the information included in this document, but California Eastern Laboratories does not warrant that such information is error free. California Eastern Laboratories and Renesas Electronics assumes no liability whatsoever for any damages incurred by you resulting from errors in or omissions from the information included herein.
3. California Eastern Laboratories and Renesas Electronics do not assume any liability for infringement of patents, copyrights, or other intellectual property rights of third parties by or arising from the use of Renesas Electronics products or technical information described in this document. No license, express, implied or otherwise, is granted hereby under any patents, copyrights or other intellectual property rights of California Eastern Laboratories or Renesas Electronics or others.
4. You should not alter, modify, copy, or otherwise misappropriate any Renesas Electronics product, whether in whole or in part. California Eastern Laboratories and Renesas Electronics assume no responsibility for any losses incurred by you or third parties arising from such alteration, modification, copy or otherwise misappropriation of Renesas Electronics product.
5. Renesas Electronics products are classified according to the following two quality grades: "Standard" and "High Quality". The recommended applications for each Renesas Electronics product depends on the product's quality grade, as indicated below. "Standard": Computers; office equipment; communications equipment; test and measurement equipment; audio and visual equipment; home electronic appliances; machine tools; personal electronic equipment; and industrial robots etc. "High Quality": Transportation equipment (automobiles, trains, ships, etc.); traffic control systems; anti-disaster systems; anti-crime systems; and safety equipment etc. Renesas Electronics products are neither intended nor authorized for use in products or systems that may pose a direct threat to human life or bodily injury (artificial life support devices or systems, surgical implantations etc.), or may cause serious property damages (nuclear reactor control systems, military equipment etc.). You must check the quality grade of each Renesas Electronics product before using it in a particular application. You may not use any Renesas Electronics product for any application for which it is not intended. California Eastern Laboratories and Renesas Electronics shall not be in any way liable for any damages or losses incurred by you or third parties arising from the use of any Renesas Electronics product for which the product is not intended by California Eastern Laboratories or Renesas Electronics.
6. You should use the Renesas Electronics products described in this document within the range specified by California Eastern Laboratories, especially with respect to the maximum rating, operating supply voltage range, movement power voltage range, heat radiation characteristics, installation and other product characteristics. California Eastern Laboratories shall have no liability for malfunctions or damages arising out of the use of Renesas Electronics products beyond such specified ranges.
7. Although Renesas Electronics endeavors to improve the quality and reliability of its products, semiconductor products have specific characteristics such as the occurrence of failure at a certain rate and malfunctions under certain use conditions. Further, Renesas Electronics products are not subject to radiation resistance design. Please be sure to implement safety measures to guard them against the possibility of physical injury, and injury or damage caused by fire in the event of the failure of a Renesas Electronics product, such as safety design for hardware and software including but not limited to redundancy, fire control and malfunction prevention, appropriate treatment for aging degradation or any other appropriate measures. Because the evaluation of microcomputer software alone is very difficult, please evaluate the safety of the final products or systems manufactured by you.
8. Please contact a California Eastern Laboratories sales office for details as to environmental matters such as the environmental compatibility of each Renesas Electronics product. Please use Renesas Electronics products in compliance with all applicable laws and regulations that regulate the inclusion or use of controlled substances, including without limitation, the EU RoHS Directive. California Eastern Laboratories and Renesas Electronics assume no liability for damages or losses occurring as a result of your noncompliance with applicable laws and regulations.
9. Renesas Electronics products and technology may not be used for or incorporated into any products or systems whose manufacture, use, or sale is prohibited under any applicable domestic or foreign laws or regulations. You should not use Renesas Electronics products or technology described in this document for any purpose relating to military applications or use by the military, including but not limited to the development of weapons of mass destruction. When exporting the Renesas Electronics products or technology described in this document, you should comply with the applicable export control laws and regulations and follow the procedures required by such laws and regulations.
10. It is the responsibility of the buyer or distributor of California Eastern Laboratories, who distributes, disposes of, or otherwise places the Renesas Electronics product with a third party, to notify such third party in advance of the contents and conditions set forth in this document, California Eastern Laboratories and Renesas Electronics assume no responsibility for any losses incurred by you or third parties as a result of unauthorized use of Renesas Electronics products.
11. This document may not be reproduced or duplicated in any form, in whole or in part, without prior written consent of California Eastern Laboratories.
12. Please contact a California Eastern Laboratories sales office if you have any questions regarding the information contained in this document or Renesas Electronics products, or if you have any other inquiries.

**NOTE 1:** "Renesas Electronics" as used in this document means Renesas Electronics Corporation and also includes its majority-owned subsidiaries.

**NOTE 2:** "Renesas Electronics product(s)" means any product developed or manufactured by or for Renesas Electronics.

**NOTE 3:** Products and product information are subject to change without notice.

**CEL Headquarters** • 4590 Patrick Henry Drive, Santa Clara, CA 95054 • Phone (408) 919-2500 • [www.cel.com](http://www.cel.com)

For a complete list of sales offices, representatives and distributors,  
Please visit our website: [www.cel.com/contactus](http://www.cel.com/contactus)