

## CPDU24V0U-HF

**RoHS Device**  
**Halogen Free**



### Features

- Uni-directional ESD protection.
- Surface mount package.
- High component density.

### Mechanical data

- Case: 0603/SOD-523F standard package, molded plastic.
- Terminals: Gold plated, solderable per MIL-STD-750, method 2026.
- Mounting position: Any.
- Weight: 0.003 grams(approx.).

### Circuit Diagram

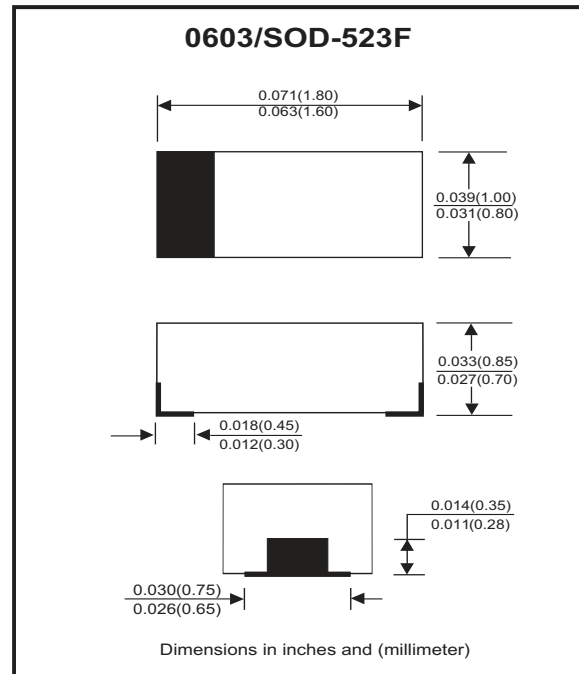

### Maximum Rating And Electrical Characteristics (at $T_A=25^{\circ}\text{C}$ unless otherwise noted)

Parameter	Conditions	Symbol	Min	Typ	Max	Unit
Forward voltage	$I_F = 10\text{mA}$	$V_F$		0.8	1.2	V
Diode breakdown voltage	$I_R = 1\text{mA}$	$V_{BD}$	26.5			V
Leakage current	$V_R = 24\text{V}$	$I_L$			0.25	$\mu\text{A}$
Junction capacitance	$V_R = 0\text{V}, f = 1\text{MHz}$	$C_T$			35	pF
ESD capability	IEC 61000-4-2(air) IEC 61000-4-2(contact)	ESD			20 15	kV
Clamping voltage	$I_{PP} = 1\text{A}, T_P=8/20\mu\text{s}$ $I_{PP} = 3\text{A}, T_P=8/20\mu\text{s}$	$V_C$			38 50	V
Peak pulse power		$P_{PP}$			150	W
Operation temperature range		$T_J$	-55		125	$^{\circ}\text{C}$
Storage temperature range		$T_{STG}$	-55		150	$^{\circ}\text{C}$

## RATING AND CHARACTERISTIC CURVES (CPDU24V0U-HF)

Fig.1 - 8/20us Peak Pulse Current Wave Form Acc. IEC 61000-4-5

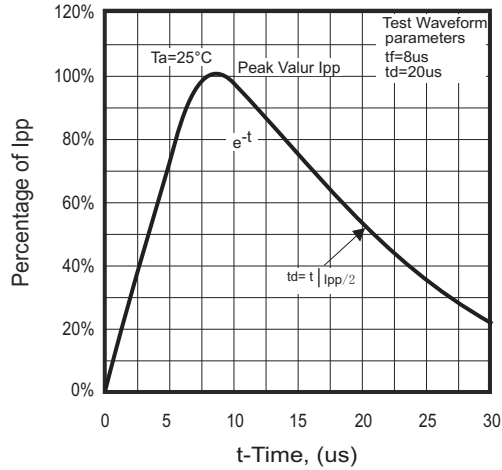

Fig.2 - Power Rating Derating Curve

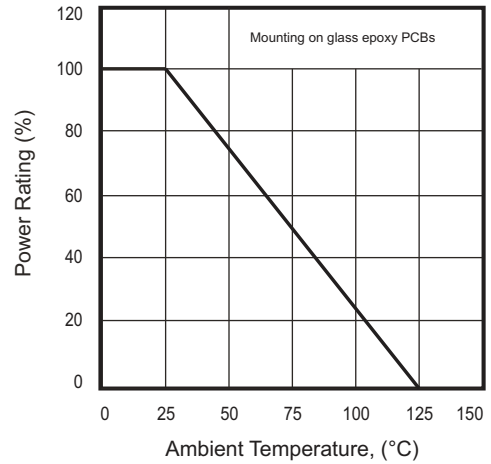

Fig.3 - Clamping Voltage Vs. Peak Pulse Current

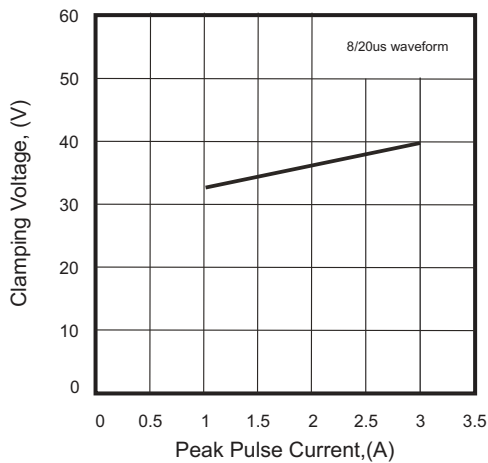

Fig.4 - Clamping Voltage Vs. Forward Peak Pulse Current

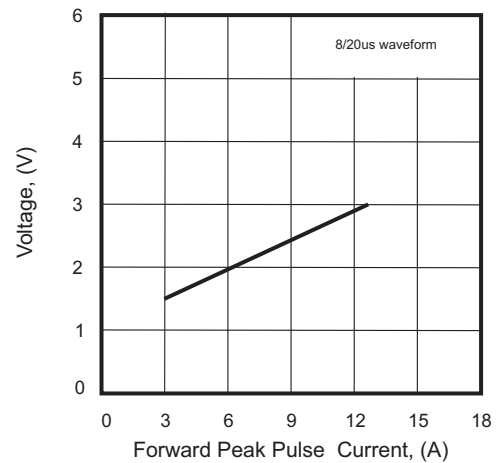
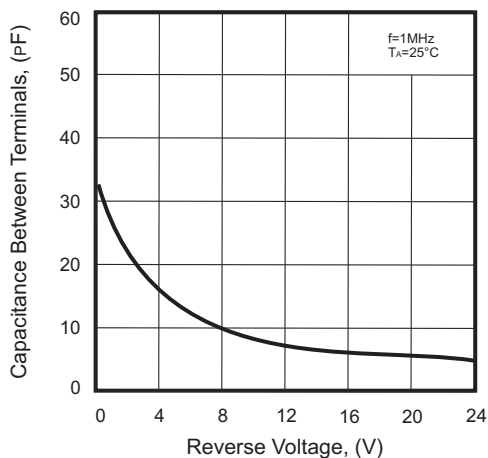

Fig.5 - Capacitance Between Terminals Characteristics



Company reserves the right to improve product design , functions and reliability without notice.

REV:B

## Reel Taping Specification

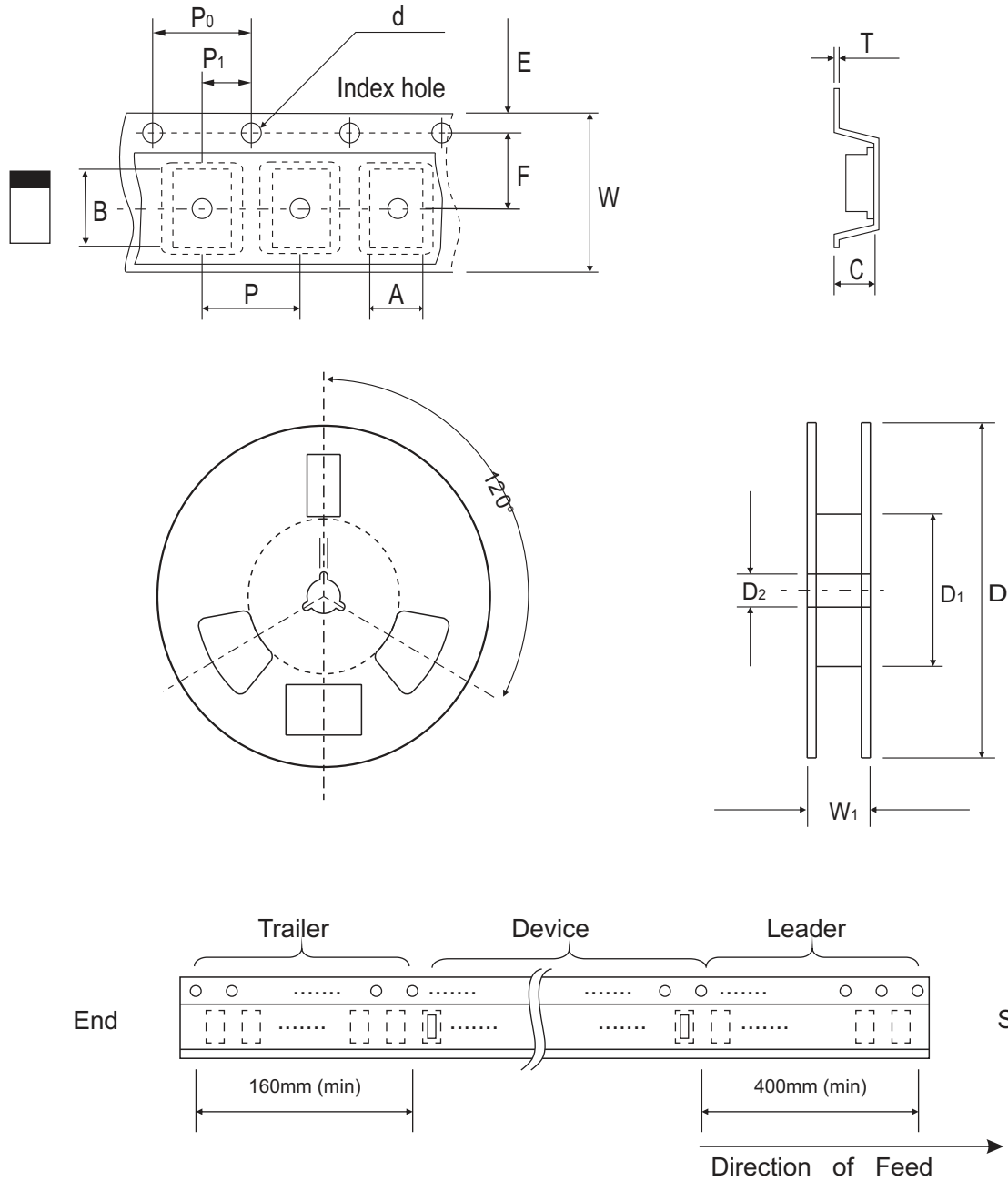

0603 (SOD-523)	SYMBOL	A	B	C	d	D	D <sub>1</sub>	D <sub>2</sub>
	(mm)	1.16 ± 0.10	1.90 ± 0.10	0.95 ± 0.10	1.50 <sup>+0.10</sup> <sub>-0</sub>	178.00 ± 1.00	60.0 ± 0.50	13.50 ± 0.20
	(inch)	0.046 ± 0.004	0.075 ± 0.004	0.037 ± 0.004	0.059 <sup>+0.004</sup> <sub>-0</sub>	7.008 ± 0.039	2.362 ± 0.020	0.531 ± 0.008

0603 (SOD-523)	SYMBOL	E	F	P	P <sub>0</sub>	P <sub>1</sub>	T	W	W <sub>1</sub>
	(mm)	1.75 ± 0.10	3.50 ± 0.05	4.00 ± 0.10	4.00 ± 0.10	2.00 ± 0.05	0.22 <sup>+0.10</sup> <sub>-0.05</sub>	8.00 ± 0.20	12.00 <sup>+0.50</sup> <sub>-0</sub>
	(inch)	0.069 ± 0.004	0.138 ± 0.002	0.157 ± 0.004	0.157 ± 0.004	0.079 ± 0.002	0.009 <sup>+0.004</sup> <sub>-0.002</sub>	0.315 ± 0.008	0.472 <sup>+0.020</sup> <sub>-0</sub>

Company reserves the right to improve product design , functions and reliability without notice.

REV:B

## Marking Code

Part Number	Marking Code
CPDU24V0U-HF	E24



## Suggested PAD Layout

SIZE	0603/SOD-523F	
	(mm)	(inch)
A	1.70	0.067
B	0.60	0.024
C	0.80	0.031
D	2.30	0.091
E	1.10	0.043

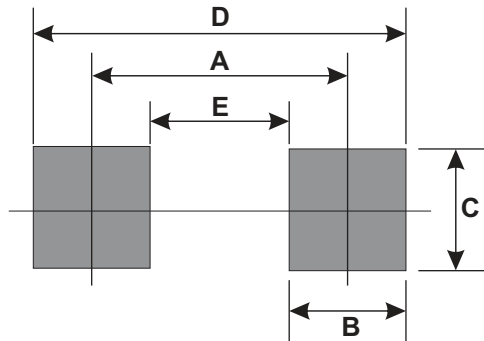

## Standard Packaging

Case Type	REEL PACK	
	REEL ( pcs )	Reel Size (inch)
0603/SOD-523F	4,000	7