

## **AN-1611 LM48555 Evaluation Board**

---

---

---

### **1 Quick Start Guide**

1. Apply power supply voltage to positive terminal of JU4, and source ground to the negative terminal.
2. Short the terminals of JU1 to release the device from shutdown mode.
3. Connect a ceramic speaker, and series resistance load across the output terminals of JU3.
4. Apply a differential audio signal to the positive and negative terminals of JU2.

### **2 Introduction**

The LM48555 is an audio power amplifier designed to drive ceramic speakers in portable applications. The LM48555 outputs 15.5V<sub>P-P</sub> with less than 1% THD + N while operating from a 3.2V power supply. The LM48555 features differential inputs for improved noise rejection and a low power shutdown mode.

The LM48555 includes advanced click and pop suppression that eliminates audible turn-on and turn-off transients. Additionally, the integrated boost regulator features a soft start function that minimizes transient current during power-up. The LM48555 is unity-gain stable and uses external gain-setting resistors.

The LM48555 Evaluation board ([Figure 1](#)) allows you to easily evaluate the performance and characteristics of the LM48555 device. It provides connectors for audio inputs, audio outputs, power supply, and shutdown control. The ceramic speaker load is not included on the demo board, an external ceramic speaker plus series resistor is needed for evaluation.

### **3 Operating Conditions**

- Temperature Range  $-40^{\circ}\text{C} \leq T_A \leq +85^{\circ}\text{C}$
- Supply Voltage  $2.7\text{V} < V_{\text{DD}} < 6.5\text{V}$

4 LM48555 Evaluation Board

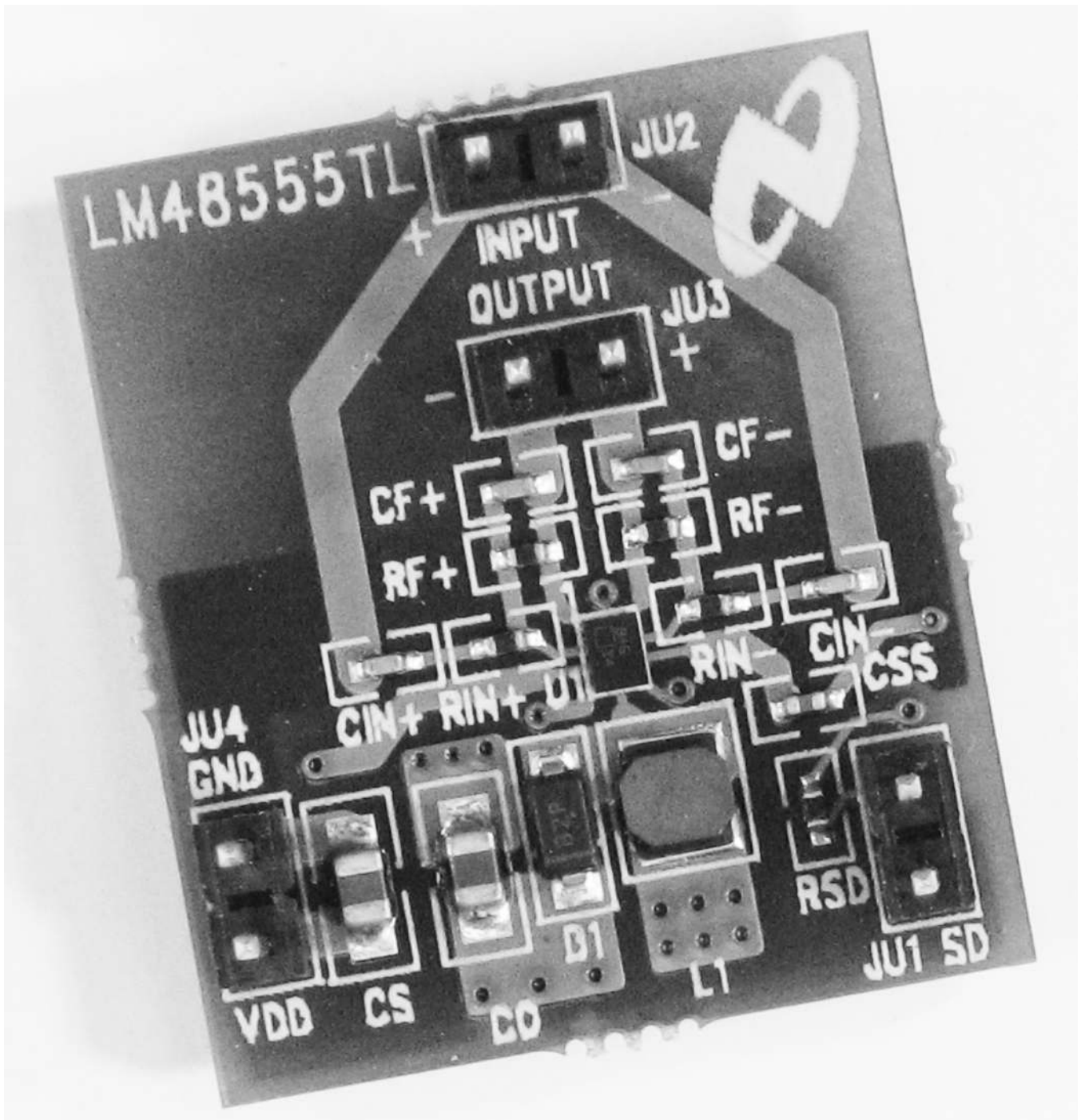
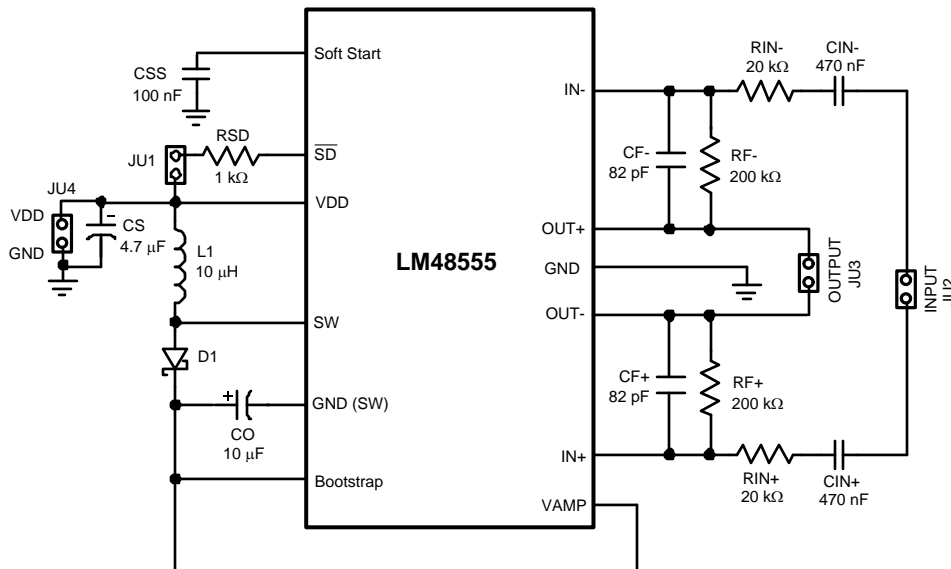

Figure 1. LM48555 Evaluation Board

## 5 Evaluation Board Schematic



**Figure 2. Evaluation Board Schematic**

## 6 Connectors

The LM48555 evaluation boards features connectors for the audio inputs, audio outputs, power supply, and shutdown control. The functionality and designators of each connector are specified in [Table 1](#).

**Table 1. Connectors**

Designator	Label	Function
JU1	Shutdown	This connector is used to control the Shutdown function: If JU1 is open, then the LM48555 is in Shutdown. If JU1 is shorted, then the LM48555 is active.
JU2	Audio Input	This connector connects the audio input signal to the device inputs. Apply the positive signal source to the pin labeled "+" and the negative signal source to the pin labeled "-".
JU3	Audio Output	This connector provides a connection to the amplifier outputs. A ceramic speaker load, and series resistors, should be connected across these terminals.
JU4	Power Supply	This connector provides the power supply connection. Apply an external power supply's positive voltage to the pin labeled V <sub>DD</sub> and the ground source to the pin labeled GND.

## 7 Bill of Materials

**Table 2. Bill of Materials**

Designator	Part Description	Manufacturer	Part Number
D2	Diode Schottky 20V 0.5A SOD123	ON Semi	MBR0520LT1G
L1	INDUCTOR 10μH 20% SMD	Taiyo Yuden	NR3010T100M
CIN+, CIN-	Capacitor Ceramic 0.47μF 10V X5R 0402	Murata	GRM155R61A474KE15D
CO	Capacitor Ceramic 10μF 16V X5R 0805	Taiyo Yuden	EMK212BJ106KG-T
CSS	Capacitor Ceramic 0.1μF 25V X5R 0402	Murata	TMK105BJ104KV-F
CF+, CF-	Capacitor Ceramic 82pF 50V 5% C0G 0402	Murata	GRM1555C1H820JZ01D
CS	Capacitor Ceramic 4.7μF 16V X5R 0805	Taiyo Yuden	EMK212BJ475KG-T

**Table 2. Bill of Materials (continued)**

Designator	Part Description	Manufacturer	Part Number
RF+, RF-	Resistor 200kΩ 1/16W 1% 0402 SMD	Panasonic	ERJ-2RKF2003X
RIN+, RIN-	Resistor 20kΩ 1/16W 1% 0402 SMD	Panasonic	ERJ-2RKF2002X
RSD	Resistor 1.0kΩ 1/16W 1% 0402 SMD	Panasonic	ERJ-2RKF1001X

## 8 Evaluation Board Components

Part number and manufacturer information for the components on the LM48555 evaluation board can be found in the Bill of Materials ([Table 2](#)). For more information on component selection refer to the LM48555 datasheet.

## 9 PCB Layout Guidelines

High frequency boost converters require very careful layout of components in order to get stable operation and low noise. All components must be as close as possible to the LM4962 device. It is recommended that a four-layer PCB be used so that internal ground planes are available. See [Figure 3](#) through [Figure 8](#) for demo board reference schematic and layout. Some additional guidelines to be observed:

- Keep the path between L1, D1, and CO extremely short. Parasitic trace inductance in series with D1 and C0 will increase noise and ringing.
- If internal ground planes are available (recommended) use vias to connect directly to ground at the GND (SW) and GND pins of U1, as well as the negative sides of capacitors CS and CO.

## 10 General Layout Recommendations

This section provides practical guidelines for PCB layouts. Designers should note that these are only rule-of-thumb recommendations and the actual results will depend heavily on the final layout.

### 10.1 Power and Ground Circuits

For multi-layer boards, it is important to isolate the switching power and ground trace paths from the amplifier power and ground trace paths. Star trace routing techniques (bringing individual traces back to a central point rather than daisy chaining traces together in a serial manner) can have a major impact on low level signal performance. Star trace routing refers to using individual traces to feed power and ground to each circuit or even device. This technique will require a greater amount of design time but will not increase the final price of the board.

### 10.2 Avoiding Typical Design / Layout Problems

Avoid ground loops or running digital and analog traces parallel to each other (side-by-side) on the same PCB layer. When traces must cross over each other, do it at 90 degrees. Running digital and analog traces at 90 degrees to each other from the top to the bottom side as much as possible will minimize capacitive noise coupling and crosstalk.

## 11 Micro SMD Wafer Level Chip Scale Package: PCB, Layout, and Mounting Considerations

Please refer to *AN-1112 DSBGA Wafer Level Chip Scale Package* ([SNVA009](#)) for possible updates to the μSMD package information.

12 PCB Layout

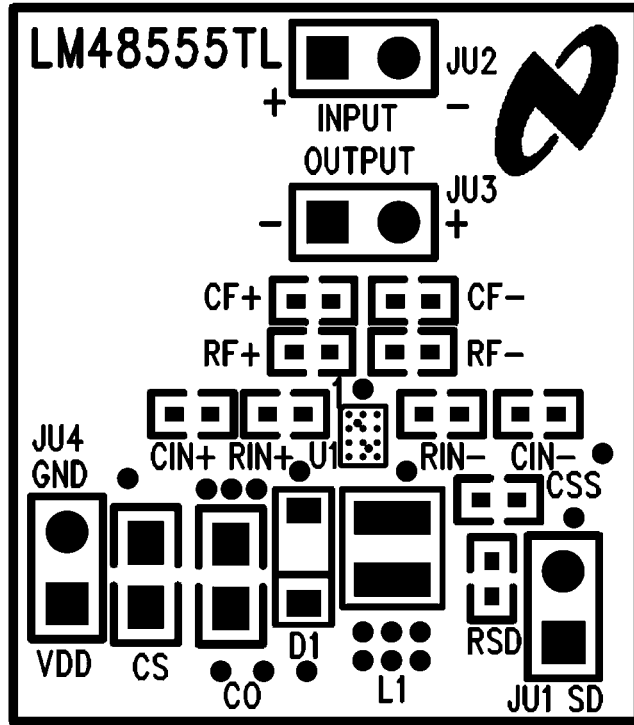

Figure 3. Silkscreen Top

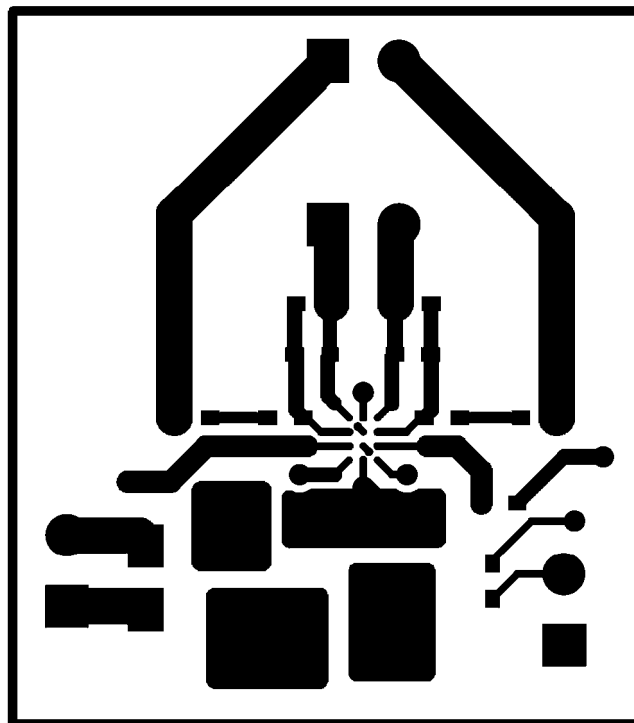

Figure 4. Top Layer

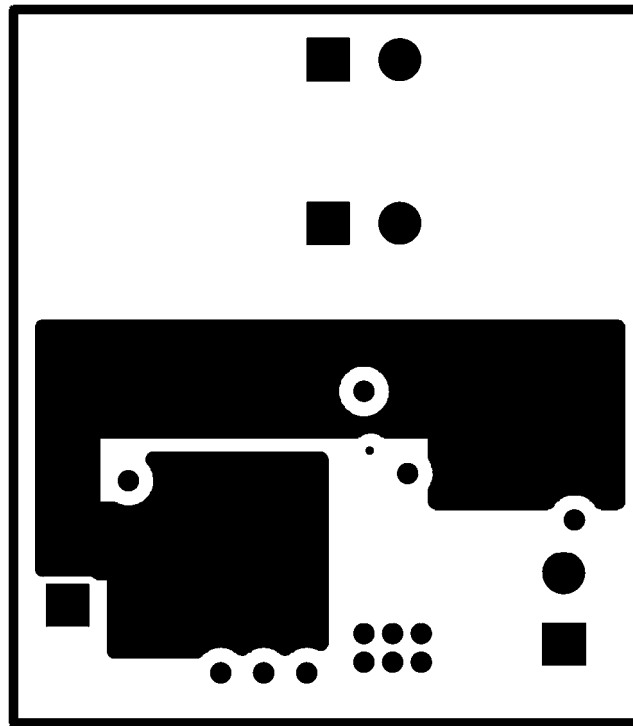

Figure 5. Layer 2

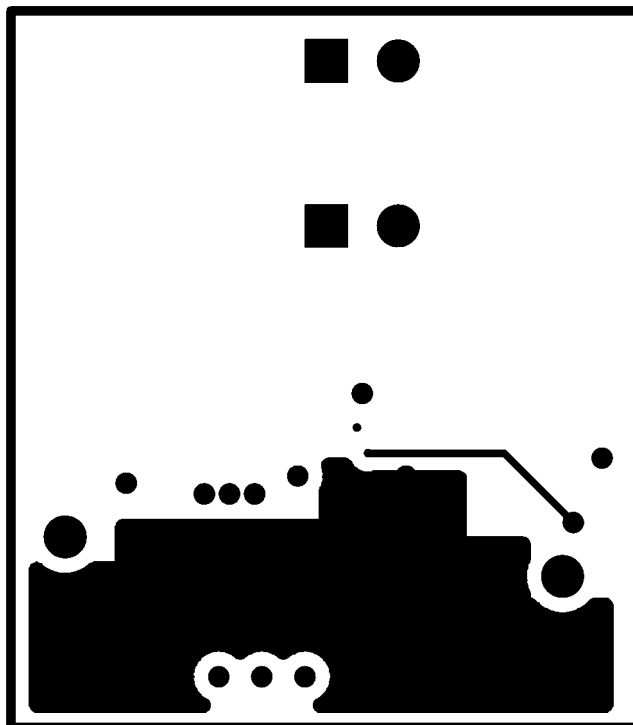

Figure 6. Layer 3

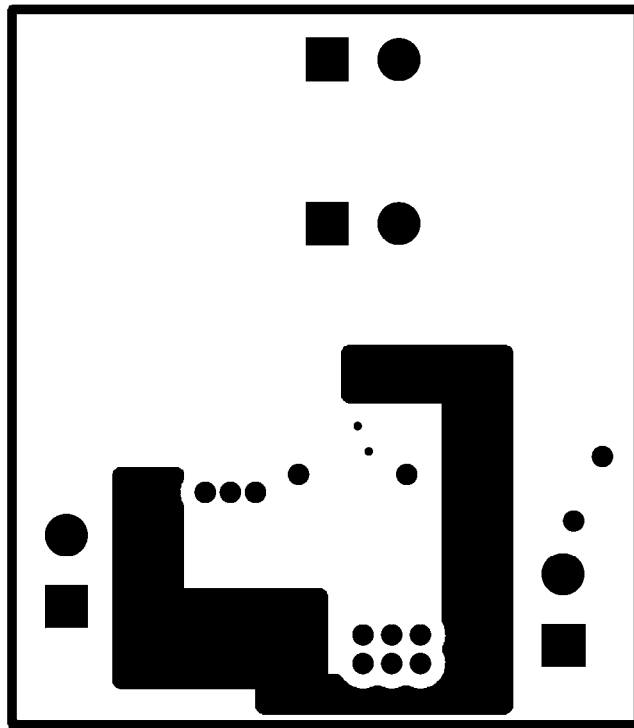

Figure 7. Bottom Layer



Figure 8. Silkscreen Bottom

**13 Revision Table**

<b>Rev</b>	<b>Date</b>	<b>Description</b>
1.0	04/03/07	Initial release.



## IMPORTANT NOTICE

Texas Instruments Incorporated and its subsidiaries (TI) reserve the right to make corrections, enhancements, improvements and other changes to its semiconductor products and services per JESD46, latest issue, and to discontinue any product or service per JESD48, latest issue. Buyers should obtain the latest relevant information before placing orders and should verify that such information is current and complete. All semiconductor products (also referred to herein as "components") are sold subject to TI's terms and conditions of sale supplied at the time of order acknowledgment.

TI warrants performance of its components to the specifications applicable at the time of sale, in accordance with the warranty in TI's terms and conditions of sale of semiconductor products. Testing and other quality control techniques are used to the extent TI deems necessary to support this warranty. Except where mandated by applicable law, testing of all parameters of each component is not necessarily performed.

TI assumes no liability for applications assistance or the design of Buyers' products. Buyers are responsible for their products and applications using TI components. To minimize the risks associated with Buyers' products and applications, Buyers should provide adequate design and operating safeguards.

TI does not warrant or represent that any license, either express or implied, is granted under any patent right, copyright, mask work right, or other intellectual property right relating to any combination, machine, or process in which TI components or services are used. Information published by TI regarding third-party products or services does not constitute a license to use such products or services or a warranty or endorsement thereof. Use of such information may require a license from a third party under the patents or other intellectual property of the third party, or a license from TI under the patents or other intellectual property of TI.

Reproduction of significant portions of TI information in TI data books or data sheets is permissible only if reproduction is without alteration and is accompanied by all associated warranties, conditions, limitations, and notices. TI is not responsible or liable for such altered documentation. Information of third parties may be subject to additional restrictions.

Resale of TI components or services with statements different from or beyond the parameters stated by TI for that component or service voids all express and any implied warranties for the associated TI component or service and is an unfair and deceptive business practice. TI is not responsible or liable for any such statements.

Buyer acknowledges and agrees that it is solely responsible for compliance with all legal, regulatory and safety-related requirements concerning its products, and any use of TI components in its applications, notwithstanding any applications-related information or support that may be provided by TI. Buyer represents and agrees that it has all the necessary expertise to create and implement safeguards which anticipate dangerous consequences of failures, monitor failures and their consequences, lessen the likelihood of failures that might cause harm and take appropriate remedial actions. Buyer will fully indemnify TI and its representatives against any damages arising out of the use of any TI components in safety-critical applications.

In some cases, TI components may be promoted specifically to facilitate safety-related applications. With such components, TI's goal is to help enable customers to design and create their own end-product solutions that meet applicable functional safety standards and requirements. Nonetheless, such components are subject to these terms.

No TI components are authorized for use in FDA Class III (or similar life-critical medical equipment) unless authorized officers of the parties have executed a special agreement specifically governing such use.

Only those TI components which TI has specifically designated as military grade or "enhanced plastic" are designed and intended for use in military/aerospace applications or environments. Buyer acknowledges and agrees that any military or aerospace use of TI components which have **not** been so designated is solely at the Buyer's risk, and that Buyer is solely responsible for compliance with all legal and regulatory requirements in connection with such use.

TI has specifically designated certain components as meeting ISO/TS16949 requirements, mainly for automotive use. In any case of use of non-designated products, TI will not be responsible for any failure to meet ISO/TS16949.

### Products

Audio	<a href="http://www.ti.com/audio">www.ti.com/audio</a>
Amplifiers	<a href="http://amplifier.ti.com">amplifier.ti.com</a>
Data Converters	<a href="http://dataconverter.ti.com">dataconverter.ti.com</a>
DLP® Products	<a href="http://www.dlp.com">www.dlp.com</a>
DSP	<a href="http://dsp.ti.com">dsp.ti.com</a>
Clocks and Timers	<a href="http://www.ti.com/clocks">www.ti.com/clocks</a>
Interface	<a href="http://interface.ti.com">interface.ti.com</a>
Logic	<a href="http://logic.ti.com">logic.ti.com</a>
Power Mgmt	<a href="http://power.ti.com">power.ti.com</a>
Microcontrollers	<a href="http://microcontroller.ti.com">microcontroller.ti.com</a>
RFID	<a href="http://www.ti-rfid.com">www.ti-rfid.com</a>
OMAP Applications Processors	<a href="http://www.ti.com/omap">www.ti.com/omap</a>
Wireless Connectivity	<a href="http://www.ti.com/wirelessconnectivity">www.ti.com/wirelessconnectivity</a>

### Applications

Automotive and Transportation	<a href="http://www.ti.com/automotive">www.ti.com/automotive</a>
Communications and Telecom	<a href="http://www.ti.com/communications">www.ti.com/communications</a>
Computers and Peripherals	<a href="http://www.ti.com/computers">www.ti.com/computers</a>
Consumer Electronics	<a href="http://www.ti.com/consumer-apps">www.ti.com/consumer-apps</a>
Energy and Lighting	<a href="http://www.ti.com/energy">www.ti.com/energy</a>
Industrial	<a href="http://www.ti.com/industrial">www.ti.com/industrial</a>
Medical	<a href="http://www.ti.com/medical">www.ti.com/medical</a>
Security	<a href="http://www.ti.com/security">www.ti.com/security</a>
Space, Avionics and Defense	<a href="http://www.ti.com/space-avionics-defense">www.ti.com/space-avionics-defense</a>
Video and Imaging	<a href="http://www.ti.com/video">www.ti.com/video</a>

### TI E2E Community

[e2e.ti.com](http://e2e.ti.com)