

Approval Sheet

(產品承認書)

產品名稱 (Product)	<u>Bluetooth Low Energy Module</u>
解決方案 (Solution)	<u>Nordic nRF5340 WLCSP Package</u>
產品型號 (Model No.)	<u>MDBT53 – 1M (Chip Antenna)</u>
	<u>MDBT53 – P1M (PCB Antenna)</u>
產品料號 (Part No.)	<u>see 4.3 Order Code</u>

Model	Working distance (in Meters)			Operating Temperature
	125 Kbps	1 Mbps	2 Mbps	
MDBT53-1M	over 240	over 200	over 160	-40 ~ 105°C
MDBT53-P1M	over 210	up to 180	up to 140	-40 ~ 105°C

Working range is tested in open space

Index

1. Overall Introduction	4
1.1. Application	4
1.2. Features	5
2. Product Dimension	7
2.1. PCB Dimensions & Pin Indication	7
2.2. Recommended Layout of Solder Pad	9
2.3. RF Layout Suggestion (aka Keep-Out Area)	13
2.4. Footprint & Design Guide	16
2.5. Pin Assignment	17
3. Main Chip Solution	21
4. Shipment Packaging Information	22
4.1. Marking on Metal Shield	23
4.2. Packaging Info	24
4.3. Order Code	26
5. Specification	27
5.1. Absolute Maximum Ratings	27
5.2. Operating Conditions	28
5.3. Electrical Specifications	28
5.4. Application CPU Performance	31
5.5. Network CPU Performance	32
5.6. Power Management	32
6. Block Diagram	41
7. Antenna	42
7.1. MDBT53	42
7.2. MDBT53-P	43
8. Reference Circuit	44
8.1. Normal Voltage LDO and DC/DC Mode	45
8.2. High Voltage LDO and DC/DC Mode	47
8.3. USB Power LDO and DC/DC Mode	49
8.4. USB Disabled	51
9. Certification	52
9.1. Declaration ID	52
9.2. FCC Certificate (USA)	53

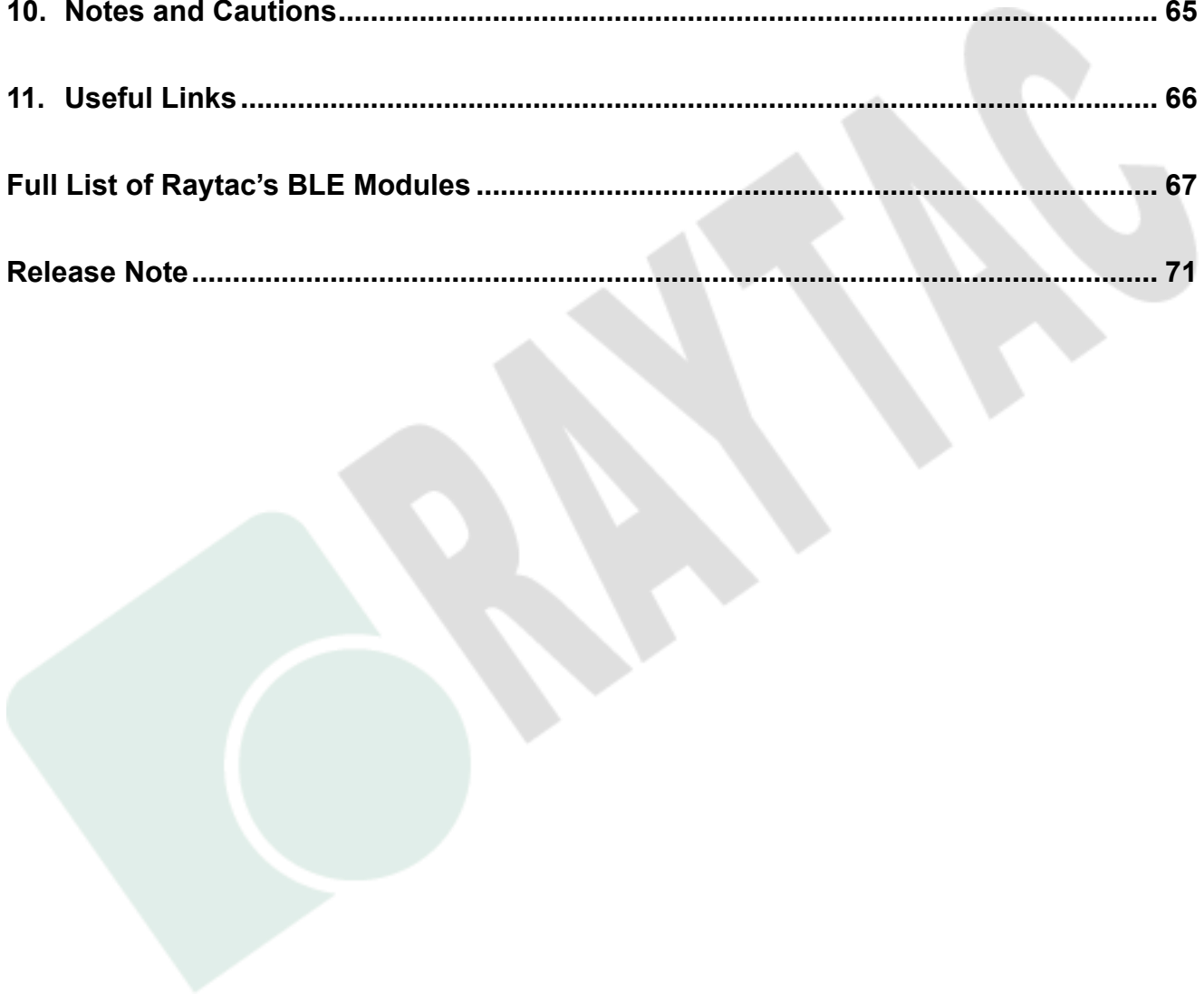

9.3.	TELEC Certificate (Japan).....	54
9.4.	NCC Certificate (Taiwan)	55
9.5.	CE (EU) & RCM (Australia & New Zealand) Test Report.....	57
9.6.	IC Certificate (Canada).....	60
9.7.	SRRC Certificate (China).....	61
9.8.	KC Certificate (South Korea)	62
9.9.	RoHS & REACH Report	63
9.10.	End-Product Label.....	63
10.	Notes and Cautions.....	65
11.	Useful Links	66
	Full List of Raytac’s BLE Modules	67
	Release Note.....	71



1. Overall Introduction

Raytac's MDBT53 & MDBT53-P is a BT 5.2 stack (Bluetooth low energy or BLE) module designed based on **Nordic nRF5340 SoC solution**, which incorporates: **GPIO, SPI, UART, TWI, I2S, PDM, PWM, ADC, NFC** and **USB** interfaces for connecting peripherals and sensors.

Features:

1. Embedded 2.4GHz transceiver supports Bluetooth 5.2 ( **Bluetooth®**), IEEE 802.15.4 ( **THREAD** & Zigbee) & 2.4Ghz RF & ANT+ upon customer's preference.
2. Compact size with **(L) 14.3 x (W) 9.3 x (H) 1.85 or 1.6 mm**.
3. Low power requirements, ultra-low peak, average and idle mode power consumption.
4. Be compatible with a large installed base of mobile phones, tablets and computers.
5. Fully coverage of BLE software stack.
6. BLE & RF transmission switching helps products fit all operation system and most hardware.

1.1. Application

- Advanced computer peripherals and I/o devices
 - Multi-touch trackpad
- Advanced wearables
 - Health / fitness sensor and monitor devices
 - Wireless payment enabled devices.
- Wireless audio devices
 - Bluetooth Low Energy Audio
 - True wireless earbuds
 - Headphones, microphones and speakers
- Internet of Things (IoT)
 - Smart home sensors and controllers
 - Industrial IoT sensors and controllers
- Interactive entertainment devices
 - Remote controls
 - Gaming controllers
- Professional Lighting
 - Wireless connected luminaire

1.2. Features

- Supply voltage range 1.7V to 5.5V
- 1.8 V to 3.3 V regulated supply for external components
- Single 32 MHz crystal operation
- 48 general purpose I/O pins
- Operating temperature from -40 to +105°C

Network Core

- ARM® Cortex®-M33 with TrustZone® technology
- 64 MHz operation
- 256 kB flash
- 64 kB low leakage RAM
- Bluetooth® 5.2, IEEE 802.15.4-2006, 2.4 GHz transceiver
 - -98 dBm sensitivity in 1 Mbps Bluetooth Low Energy mode
 - -104 dBm sensitivity in 125 kbps Bluetooth Low Energy mode (long range)
 - -101 dBm sensitivity in IEEE 802.15.4
 - -20 to +3 dBm configurable TX power
- On-air compatible with nRF52, nRF51, nRF24L, and nRF24AP Series
- Supported data rates:
 - Bluetooth 5.2 - 2 Mbps, 1 Mbps, 500 kbps, and 125 kbps
 - IEEE 802.15.4-2006 - 250 kbps
 - Proprietary 2.4 GHz - 2 Mbps, 1 Mbps
- Angle of Arrival (AoA) and Angle of Departure (AoD) direction finding
- 128-bit AES/ECB/CCM/AAR co-processor (on-the-fly packet encryption)
- SPI master/slave with EasyDMA
- I2C compatible two-wire master/slave with EasyDMA
- UART (CTS/RTS) with EasyDMA
- Up to 3x 32-bit timer with counter mode
- Up to 2x real-time counter (RTC)

Application Core

- ARM® Cortex®-M33 with TrustZone® technology
- 128 MHz or 64 MHz operation
- Single-precision floating-point unit (FPU)
- Digital signal processing (DSP) instructions
- 1 MB flash and 512 kB low leakage RAM

- ARM TrustZone CryptoCell™-312 security subsystem
- USB 2.0 full speed (12Mbps) controller
- QSPI peripheral for communicating with an external flash memory device
- Near field communication (NFC-A) tag with wake-on field
- Up to 5x SPI master/slave with EasyDMA
- Up to 4x I2C compatible two-wire master/slave with EasyDMA
- Up to 4x UART (CTS/RTS) with EasyDMA
- Audio peripherals: I2S, digital microphone interface (PDM)
- Up to 4x pulse width modulator (PWM) units with EasyDMA
- 12-bit, 200 ksps ADC with EasyDMA - eight configurable channels with programmable gain
- Up to 3x 32-bit timer with counter mode
- Up to 2x 24-bit real-time counter (RTC)
- Up to 2x Quadrature decoder (QDEC)

2. Product Dimension

2.1. PCB Dimensions & Pin Indication

- **MDBT53**

PCB Size (in mm)			
	Min.	Norm	MAX.
L		14.3	
W	- 0.15	9.3	+ 0.2
H		1.85	

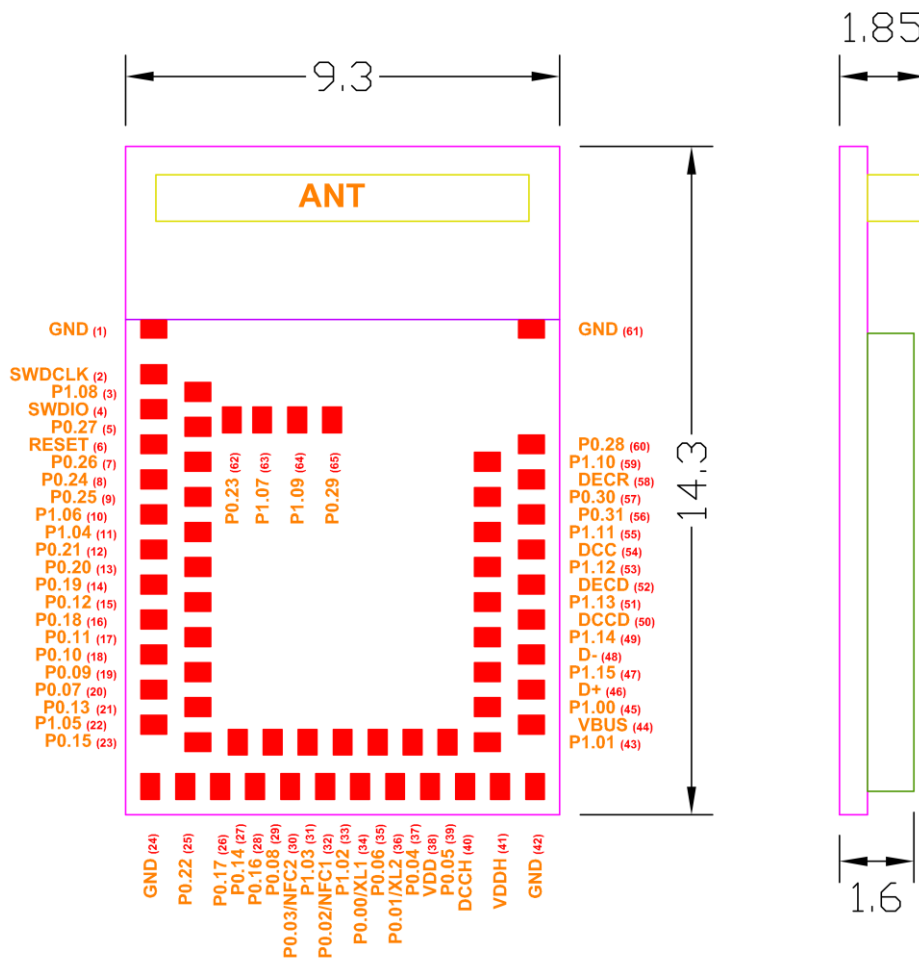

Top (Unit: mm)

• **MDBT53-P**

PCB Size (in mm)			
	Min.	Norm	MAX.
L		14.3	
W	- 0.15	9.3	+ 0.2
H		1.6	

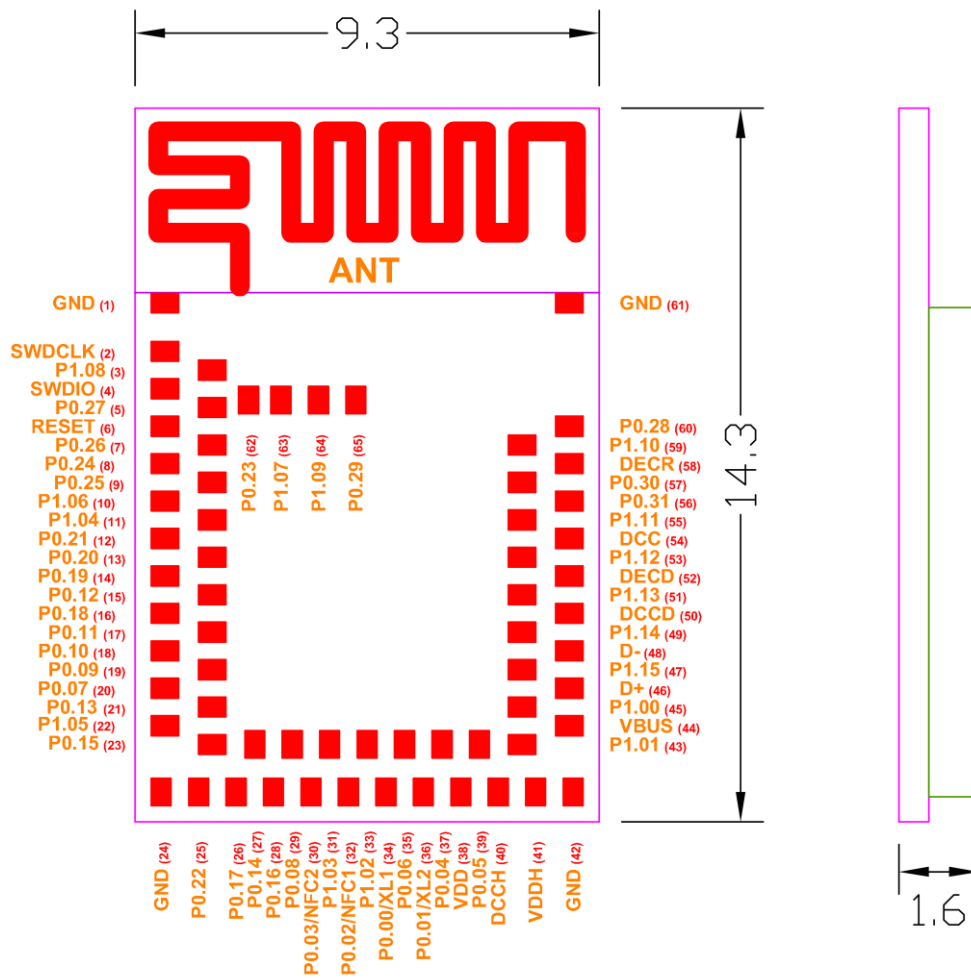

Top (Unit: mm)

2.2. Recommended Layout of Solder Pad

Graphs are all in Top View, Unit in mm.

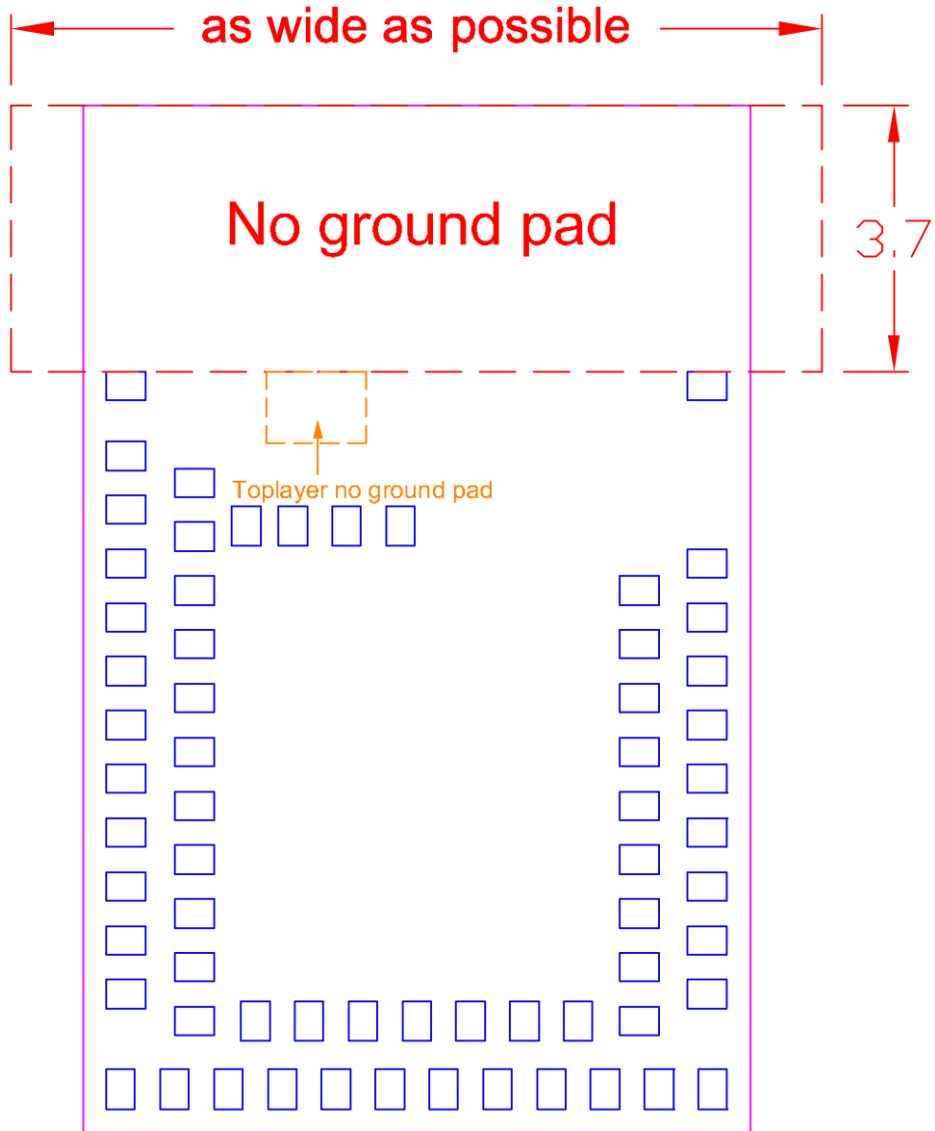

No ground pad

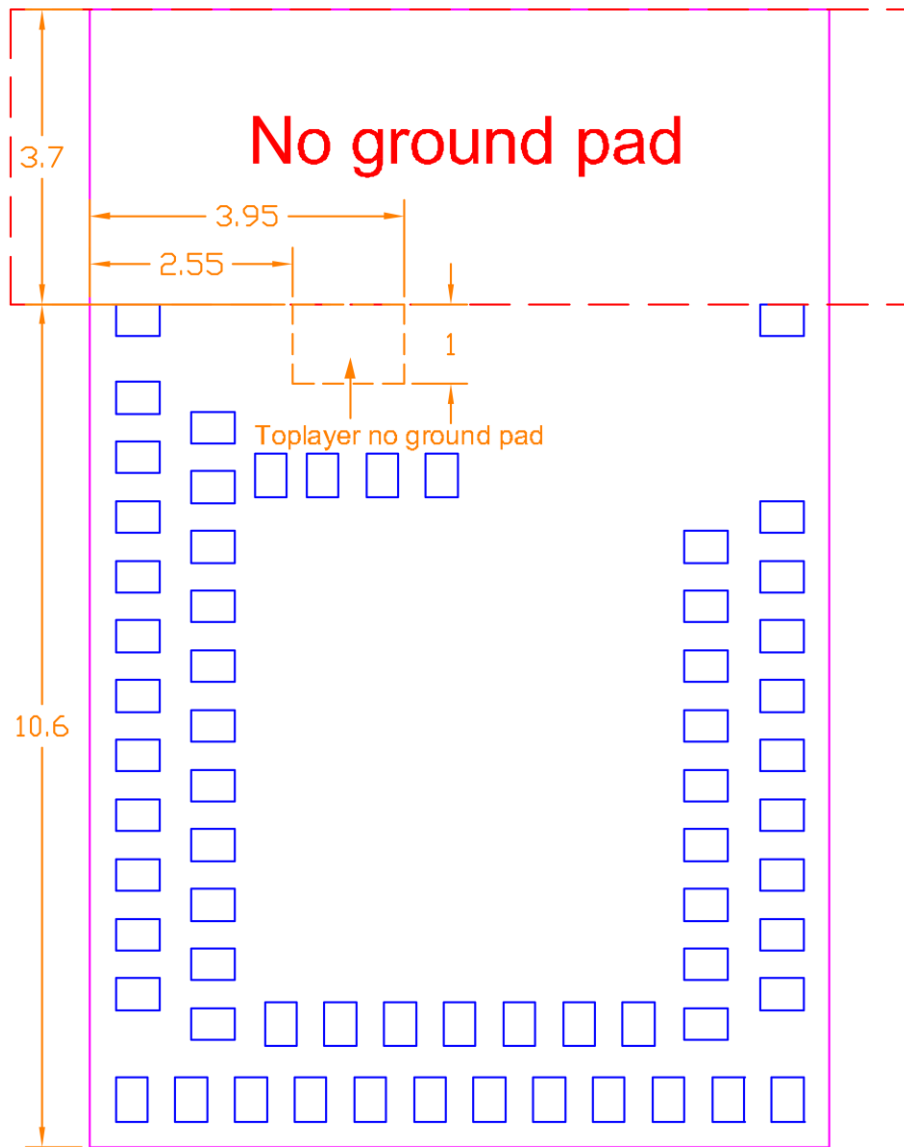

Toplayer no ground pad

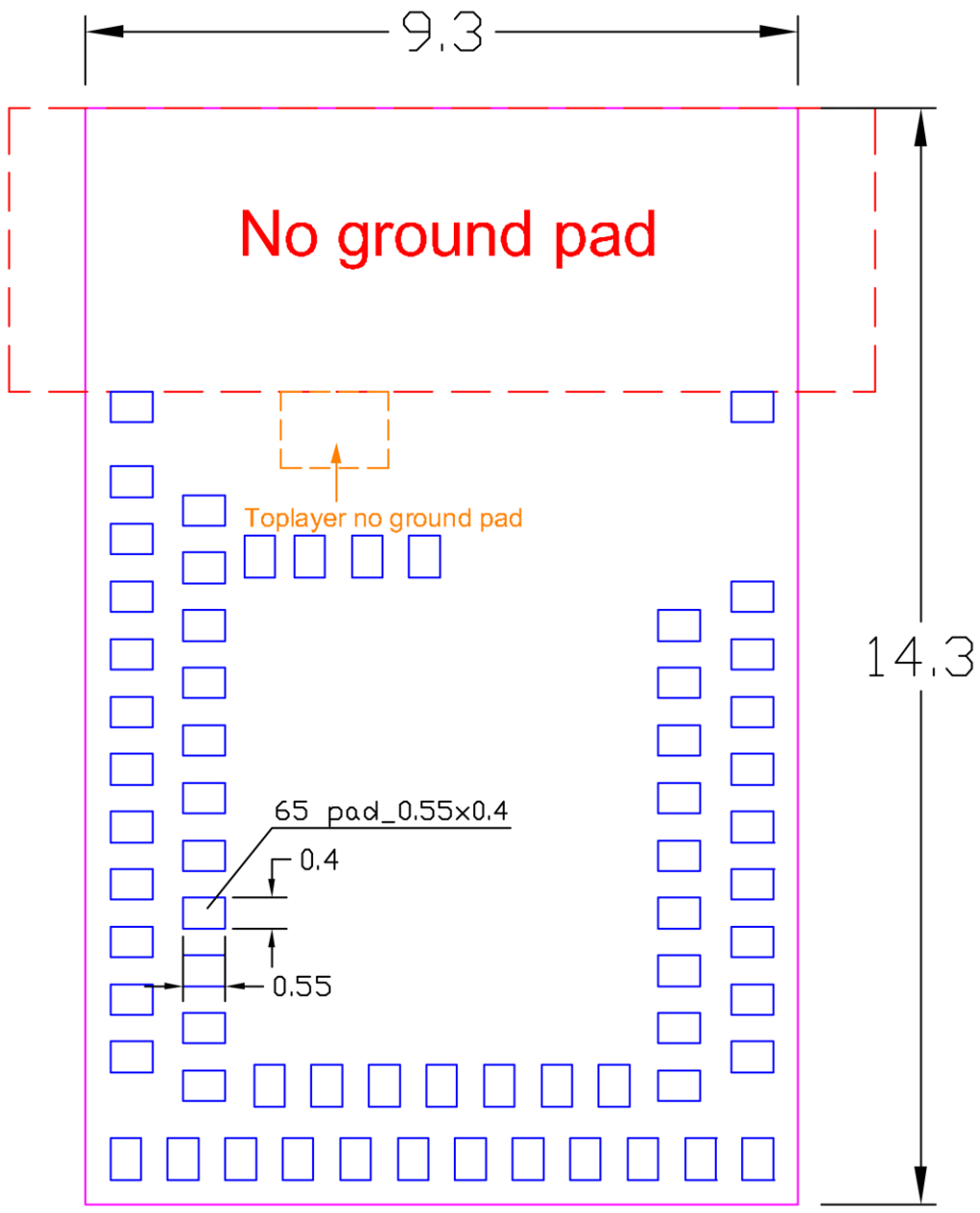

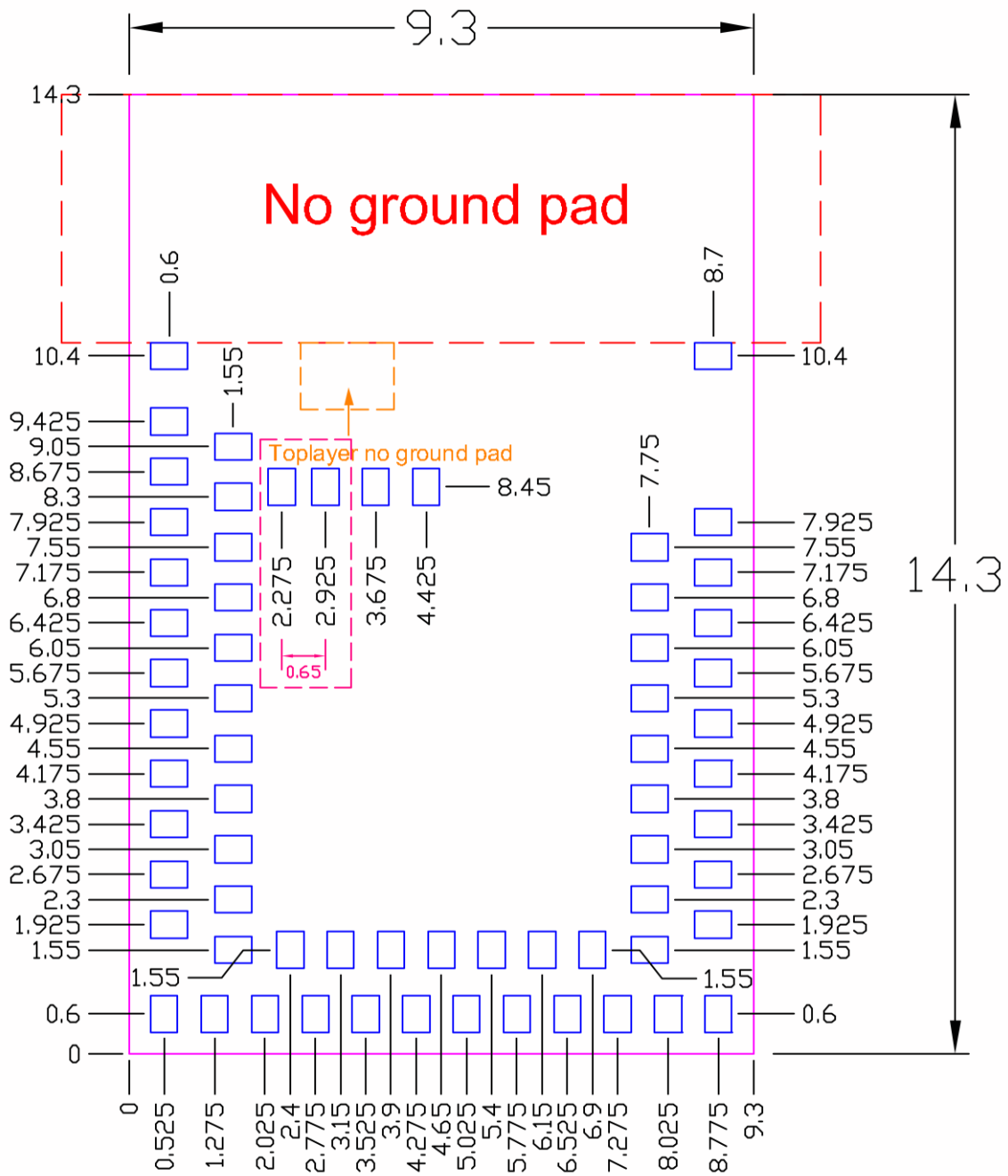

Top View (Unit : mm)
recommended solder pad layout

2.3. RF Layout Suggestion (aka Keep-Out Area)

Make sure to keep the “No Ground Pad” as wider as you can regardless of the size of your PCB.

No Ground Pad should be included in the corresponding position of the antenna in **EACH LAYER**.

Place the module towards the edge of PCB to have better performance than placing it on the center.

Welcome to send us your layout in PDF for review at service@raytac.com or your contact at Raytac with title “Layout reviewing – Raytac Model No. – YOUR company’s name”.

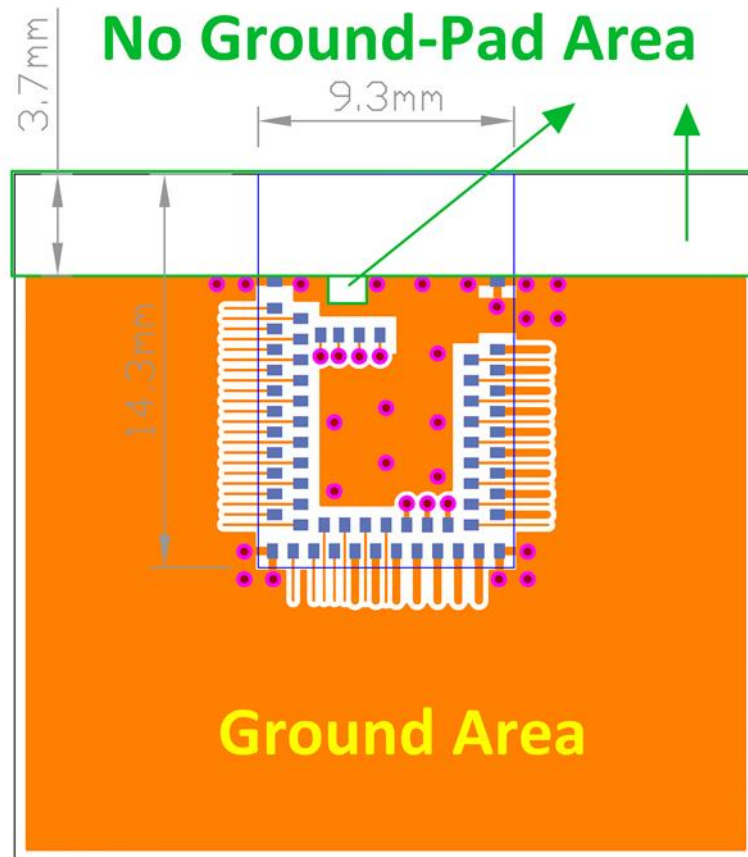

Top layer

Please add via holes in GROUND area as many as possible, especially around the four corners.

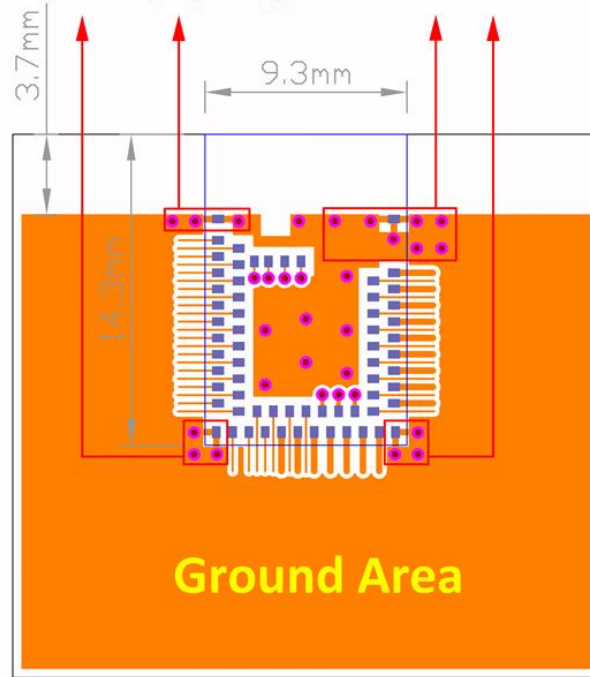

Top layer



Bottom layer

Examples of “**NOT RECOMMENDED**” layout

 where should be NO-GROUND area

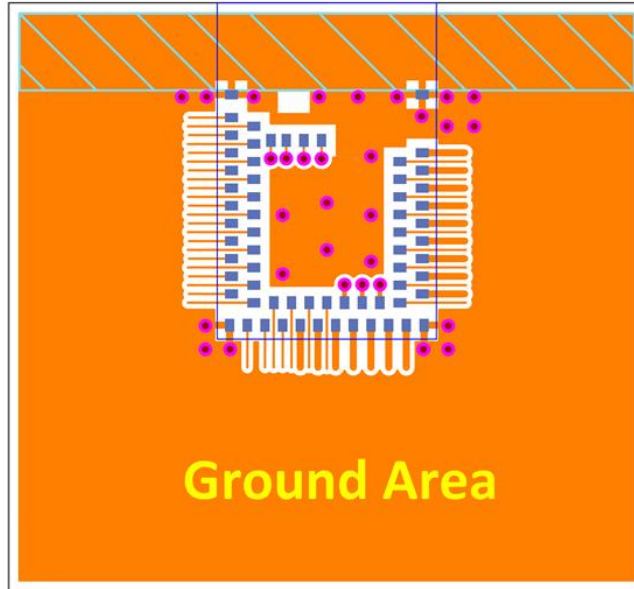

 where should be NO-GROUND area

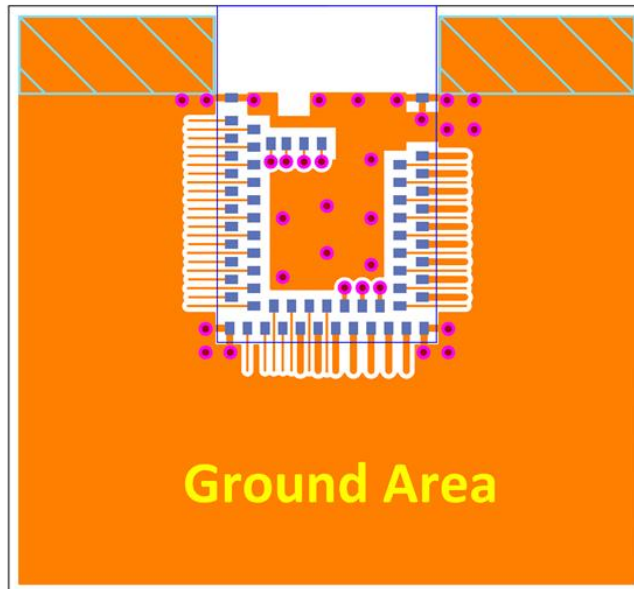

If there is limited space for layout, the module can be put on the **upper right corner** to minimize the layout space.

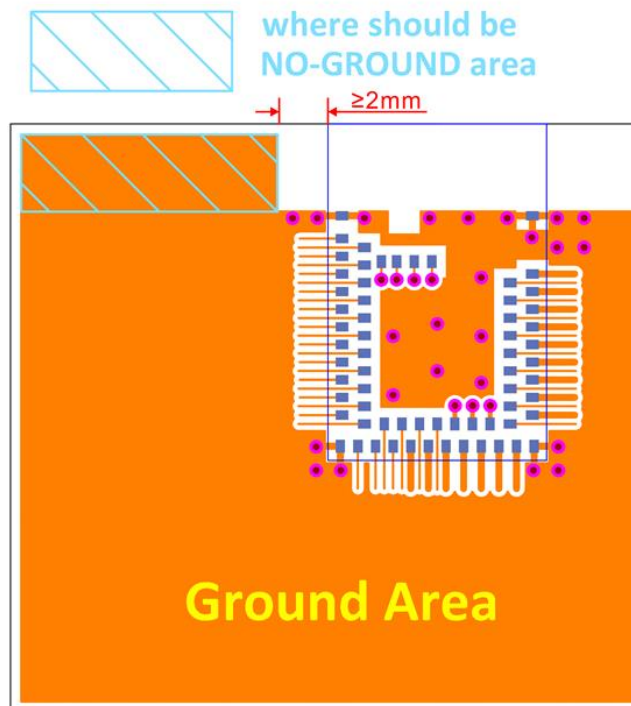

2.4. Footprint & Design Guide

Please visit "[Support](#)" page of our website to download. The package includes footprint, 2D/3D drawing, reflow graph/solder profile and recommended spec for external 32.768khz.

2.5. Pin Assignment

Pin No.	Name	Pin Function	Description
(1)	GND	Power	Ground
(2)	SWCLK	Debug	Serial wire debug I/O for debug and programming
(3)	P1.08	Digital I/O	General-purpose I/O
(4)	SWDIO	Debug	Serial wire debug I/O for debug and programming
(5)	P0.27	Digital I/O	General-purpose I/O
	AIN6	Analog input	Analog input
(6)	nRESET	Reset	Pin RESET with internal pull-up resistor
(7)	P0.26	Digital I/O	General-purpose I/O
	AIN5	Analog input	Analog input
(8)	P0.24	Digital I/O	General-purpose I/O
(9)	P0.25	Digital I/O	General-purpose I/O
	AIN4	Analog input	Analog input
(10)	P1.06	Digital I/O	General-purpose I/O
(11)	P1.04	Digital I/O	General-purpose I/O
(12)	P0.21	Digital I/O	General-purpose I/O
(13)	P0.20	Digital I/O	General-purpose I/O
(14)	P0.19	Digital I/O	General-purpose I/O
(15)	P0.12	Digital I/O	General-purpose I/O
	DCX	DCX for SPIM4	Dedicated pin for high-speed SPI
(16)	P0.18	Digital I/O	General-purpose I/O
	CSN	CSN for QSPI	Dedicated pin for Quad SPI
(17)	P0.11	Digital I/O	General-purpose I/O
	CSN	CSN for SPIM4	Dedicated pin for high-speed SPI
(18)	P0.10	Digital I/O	General-purpose I/O
	MISO	MISO for SPIM4	Dedicated pin for high-speed SPI
(19)	P0.09	Digital I/O	General-purpose I/O
	MOSI	MOSI for SPIM4	Dedicated pin for high-speed SPI
(20)	P0.07	Digital I/O	General-purpose I/O
	AIN3	Analog input	Analog input

Pin No.	Name	Pin Function	Description
(21)	P0.13	Digital I/O	General-purpose I/O
	IO0	IO0 for QSPI	Dedicated pin for Quad SPI
(22)	P1.05	Digital I/O	General-purpose I/O
(23)	P0.15	Digital I/O	General-purpose I/O
	IO2	IO2 for QSPI	Dedicated pin for Quad SPI
(24)	GND	Power	Ground
(25)	P0.22	Digital I/O	General-purpose I/O
(26)	P0.17	Digital I/O	General-purpose I/O
	SCK	SCK for QSPI	Dedicated pin for Quad SPI
(27)	P0.14	Digital I/O	General-purpose I/O
	IO1	IO1 for QSPI	Dedicated pin for Quad SPI
(28)	P0.16	Digital I/O	General-purpose I/O
	IO3	IO3 for QSPI	Dedicated pin for Quad SPI
(29)	P0.08	Digital I/O	General-purpose I/O
	SCK	SCK for SPIM4	Dedicated pin for high-speed SPI
(30)	P0.03	Digital I/O	General-purpose I/O
	NFC2	NFC input	NFC antenna connection
(31)	P1.03	Digital I/O	General-purpose I/O
	TWI	TWI 1 Mbps	High-speed pin for 1 Mbps TWI
(32)	P0.02	Digital I/O	General-purpose I/O
	NFC1	NFC input	NFC antenna connection
(33)	P1.02	Digital I/O	General-purpose I/O
	TWI	TWI 1 Mbps	High-speed pin for 1 Mbps TWI
(34)	P0.00	Digital I/O	General-purpose I/O
	XL1	Analog input	Connection for 32.768 kHz crystal
(35)	P0.06	Digital I/O	General-purpose I/O
	AIN2	Analog input	Analog input
(36)	P0.01	Digital I/O	General-purpose I/O
	XL2	Analog input	Connection for 32.768 kHz crystal

Pin No.	Name	Pin Function	Description
(37)	P0.04	Digital I/O	General-purpose I/O
	AIN0	Analog input	Analog input
(38)	VDD	Power	Power supply
(39)	P0.05	Digital I/O	General-purpose I/O
	AIN1	Analog input	Analog input
(40)	DCCH	Power	DC/DC converter output
(41)	VDDH	Power	High voltage power supply
(42)	GND	Power	Ground
(43)	P1.01	Digital I/O	General-purpose I/O
(44)	VBUS	Power	5V input for USB 3.3V regulator
(45)	P1.00	Digital I/O	General-purpose I/O
(46)	D+	Digital I/O	USB D+
(47)	P1.15	Digital I/O	General-purpose I/O
(48)	D-	Digital I/O	USB D-
(49)	P1.14	Digital I/O	General-purpose I/O
(50)	DCCD	Power	DC/DC converter output
(51)	P1.13	Digital I/O	General-purpose I/O
(52)	DECD	Power	Digital regulator supply decoupling
(53)	P1.12	Digital I/O	General-purpose I/O
(54)	DCC	Power	DC/DC converter output
(55)	P1.11	Digital I/O	General-purpose I/O
(56)	P0.31	Digital I/O	General-purpose I/O
(57)	P0.30	Digital I/O	General-purpose I/O
(58)	DECR	Power	Regulator supply decoupling
(59)	P1.10	Digital I/O	General-purpose I/O
(60)	P0.28	Digital I/O	General-purpose I/O
	AIN7	Analog input	Analog input
(61)	GND	Power	Ground

Pin No.	Name	Pin Function	Description
(62)	P0.23	Digital I/O	General-purpose I/O
(63)	P1.07	Digital I/O	General-purpose I/O
(64)	P1.09	Digital I/O	General-purpose I/O
(65)	P0.29	Digital I/O	General-purpose I/O



3. Main Chip Solution

RF IC	Crystal Frequency
Nordic NRF5340 / WLCSP	32MHZ / CL = 8pF / 20ppm

32MHz crystal is already inside the module. The module does NOT include external capacitor for 32MHZ crystal.

Default on-chip capacitor is enabled = 12.5pF

CAPVALUE: AAAAA = 01100 / on-chip capacitor enable: B = 1

Bit number	31	30	29	28	27	26	25	24	23	22	21	20	19	18	17	16	15	14	13	12	11	10	9	8	7	6	5	4	3	2	1	0										
ID																								B	A				A	A	A	A										
Reset 0x00000000	0 0																																									
ID	R/W	Field	Value ID	Value	Description																																					
A	RW	CAPVALUE			Value representing capacitance, calculated using provided equation																																					
B	RW	ENABLE	Disabled	0	Capacitor disabled (use external caps)																																					
			Enabled	1	Capacitor enabled																																					

How to calculate CAPVALUE:

$$CAPVALUE = (((FICR \rightarrow XOSC32MTRIM.SLOPE + 56) * (CAPACITANCE * 2 - 14)) + ((FICR \rightarrow XOSC32MTRIM.OFFSET - 8) \ll 4) + 32) \gg 6;$$

$$\begin{aligned}
 CAPVALUE &= (((1+56) \times (12.5 \times 2 - 14)) + ((16-8) \text{ left shift 4 digits}) + 32) \text{ right shift 6 digits} \\
 &= ((57 \times 11) + 128 + 32) \text{ right shift 6 digits} \\
 &= 787(\text{DEC}) \text{ right shift 6 digits} \\
 &= 0011\ 0001\ 0011(\text{BIN}) \text{ right shift 6 digits} \\
 &= 0000\ 1100(\text{BIN})
 \end{aligned}$$



Where FICR -> xosc32MTRIM.SLOPE = 1 (fixed for NRF5340)

Desired CAPACITANCE = 12.5PF

FICR -> xosc32MTRIM.OFFSET = 16 (fixed for NRF5340)

8(DEC) left shift 4 digits = 1000(BIN) left shift 4 digits = 1000 0000(BIN) = 128(DEC)

4. Shipment Packaging Information

Model	Antenna	Photo
MDBT53-1M	Chip/Ceramic	
MDBT53-P1M	PCB/Printed	

- Unit Weight of Module:

MDBT53-1M: 0.41 g (± 0.02 g) ; MDBT53-P1M: 0.38 g (± 0.02 g)

- Packaging Type: Tray or Tape & Reel.

	Tray	Tape & Reel
MPQ (Min. Package Q'ty)	88 pcs per tray	1,500 pcs per reel
Carton Contents (per carton)	1,760 pcs	1,500 pcs
Carton Dimension (L) x (W) x (H) cm	37 x 21 x 13	37 x 36 x 6
Gross Weight	about 2.4 kgs	about 1.9 kgs

4.1. Marking on Metal Shield

Label contexts for date code 221 and after,

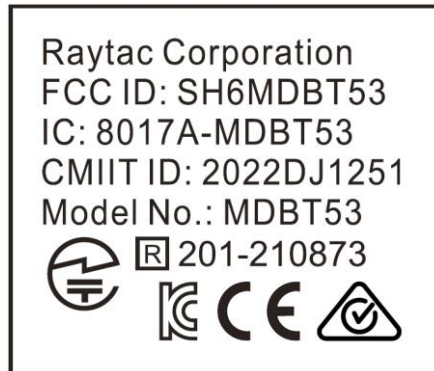

For date code 209 to 221,

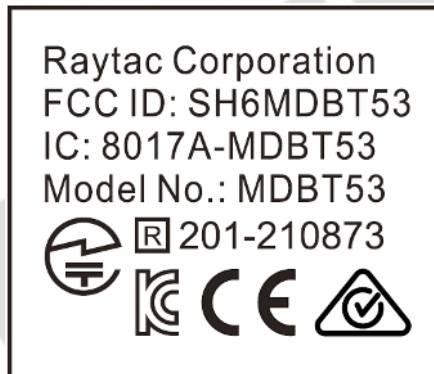

There is no marking on metal shield for module(s) with date code before 209.

4.2. Packaging Info

4.2.1. Tray Packaging

Anti-static tray is specifically designed for mass production. It can be used directly on SMT automatic machine.

Before July 1st, 2022

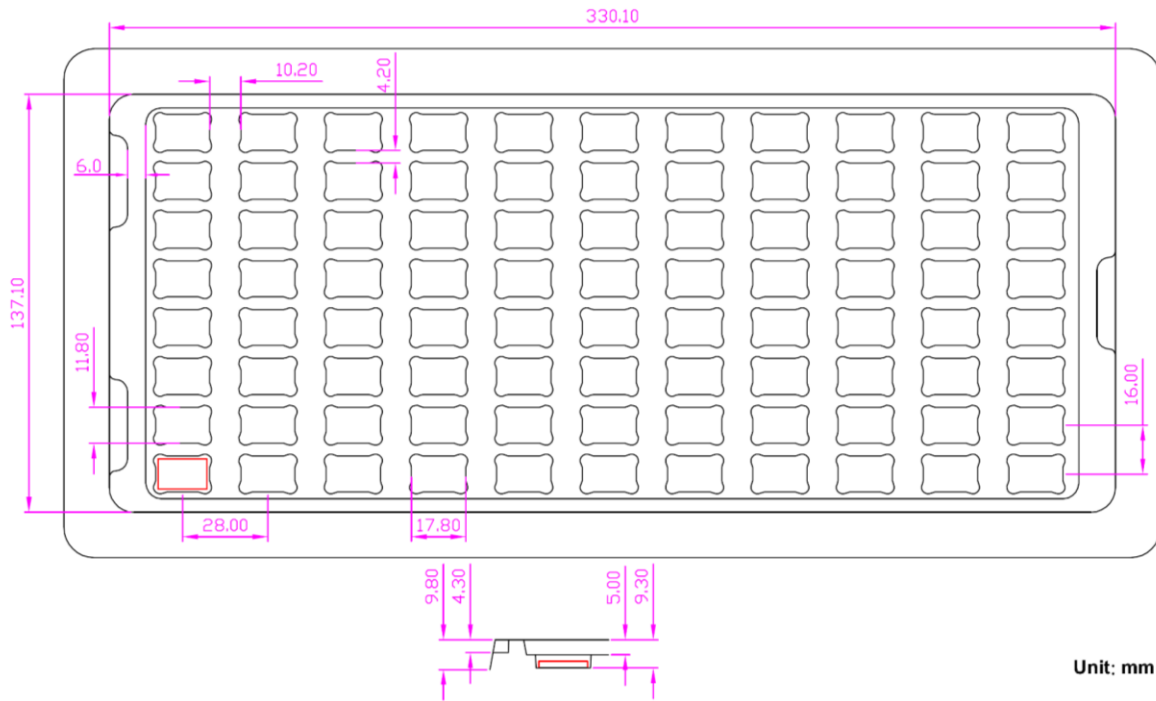

After July 1st, 2022

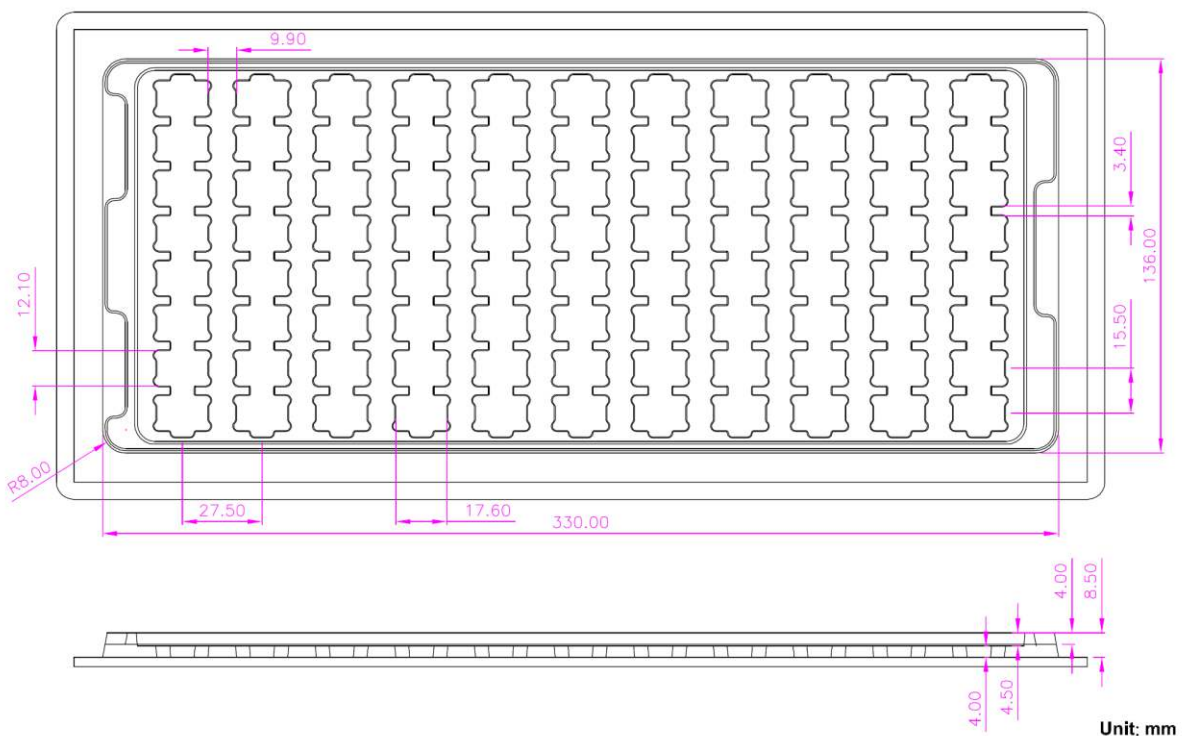

4.2.2. Reel Packaging

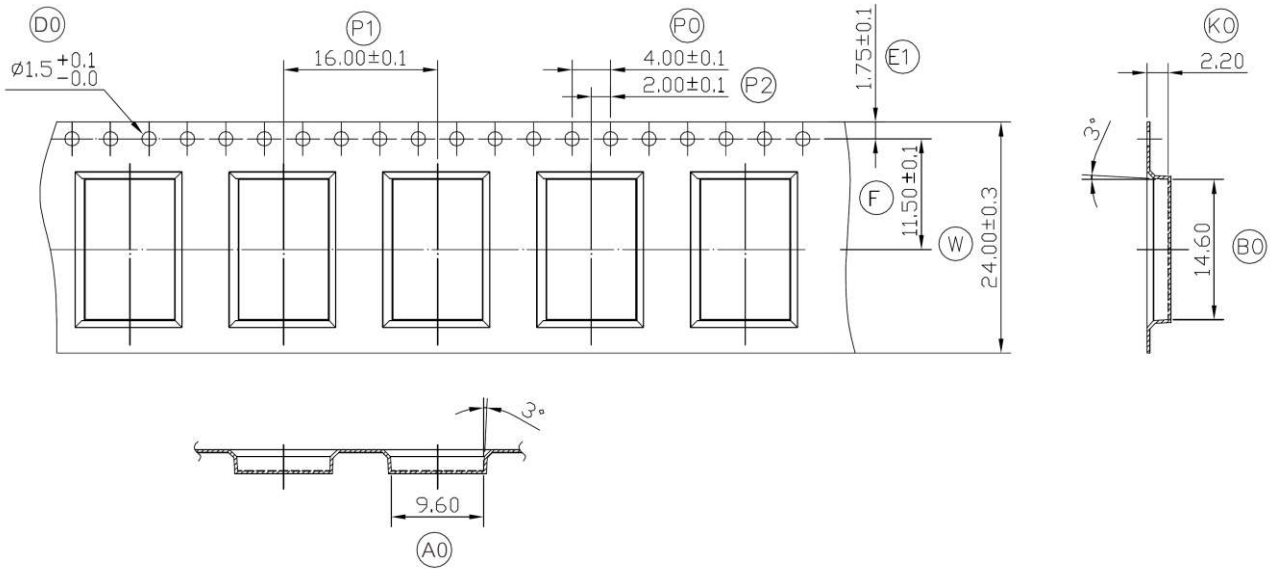

W	24.00	± 0.30
P1	16.00	± 0.10
E1	1.75	± 0.10
F	11.50	± 0.10
D0	1.50	$+0.1/-0$
P0	4.00	± 0.10
P2	2.00	± 0.10
A0	9.60	± 0.10
B0	14.60	± 0.10
K0	2.20	± 0.10
T	0.30	± 0.05

4.3. Order Code

Each model has two options of packaging. Please use following part no. when placing order to us.

Model	Tray	Tape & Reel
MDBT53-1M	MD-240A6-007	MD-240A6-007R
MDBT53-P1M	MD-240A6-008	MD-240A6-008R

MPQ of Reel packaging is 1,500 pcs and Tray packaging is 88 pcs.

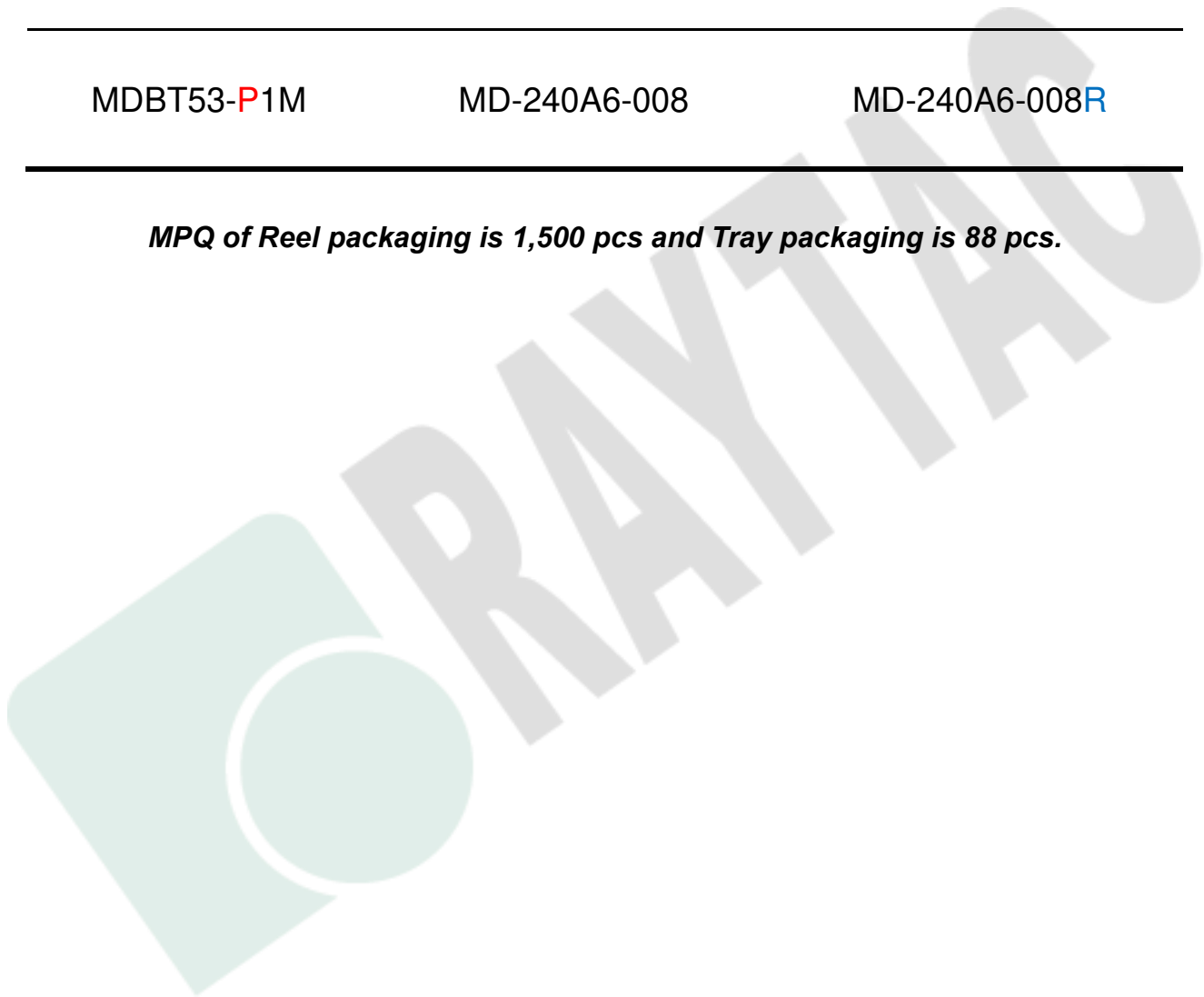

5. Specification

Any technical spec shall refer to Nordic's official documents as final reference. Contents below are from "[nRF5340 Objective Production Specification v1.3](#)", please click to download full spec.

5.1. Absolute Maximum Ratings

	Min.	Max.	Unit
Supply voltages			
VDD	-0.3	+3.9	V
VDDH	-0.3	+5.8	V
VBUS	-0.3	+5.8	V
VSS	-0.3	0	V
I/O pin voltage			
$V_{I/O}, VDD \leq 3.6\text{ V}$	-0.3	$VDD + 0.3$	V
$V_{I/O}, VDD > 3.6\text{ V}$	-0.3	3.9	V
NFC antenna pin current			
$I_{NFC1/2}$		80	mA
Radio			
RF input level		10	dBm
Environmental WLCSP package			
Storage temperature	-40	+125	°C
Moisture Sensitivity Level (MSL)		1	
ESD Human Body Model (HBM)		2	kV
		Pins DECR and DECN are 1.4	
ESD Charged Device Model (CDM)		500	V
Flash memory			
Endurance	10 000 write/erase cycles		
Retention	10 years at 40°C		

5.2. Operating Conditions

Symbol	Parameter	Min.	Nom.	Max.	Units
VDD	VDD supply voltage, independent of DCDC enable	1.7	3.0	3.6	V
VDDH	VDDH supply voltage, independent of DCDC enable	2.5	3.7	5.5	V
VBUS	VBUS USB supply voltage	4.35	5.0	5.5	V
TA	Operating temperature	-40	25	105	°C

5.3. Electrical Specifications

5.3.1. General Radio Characteristics

Symbol	Description	Min.	Typ.	Max.	Units
f_{OP}	Operating frequencies	2360		2500	MHz
$f_{PLL,CH,SP}$	PLL channel spacing		1.0		MHz
$f_{DELTA,1M}$	Frequency deviation @ 1 Mbps		±170		kHz
$f_{DELTA,BLE,1M}$	Frequency deviation @ Bluetooth LE 1 Mbps		±250		kHz
$f_{DELTA,2M}$	Frequency deviation @ 2 Mbps		±320		kHz
$f_{DELTA,BLE,2M}$	Frequency deviation @ Bluetooth LE 2 Mbps		±500		kHz
f_{skBPS}	On-the-air data rate	125		2000	kbps
$f_{chip, IEEE 802.15.4}$	Chip rate in IEEE 802.15.4 mode		2000		kchip/s

5.3.2. Radio Current Consumption (Transmitter)

Symbol	Description	Min.	Typ.	Max.	Units
$I_{TX,PLUS3dBm,DCDC}$	TX only run current DC/DC, 3 V, $P_{RF} = +3$ dBm		5.1		mA
$I_{TX,PLUS3dBm}$	TX only run current $P_{RF} = +3$ dBm		11.3		mA
$I_{TX,0dBm,DCDC}$	TX only run current DC/DC, 3 V, $P_{RF} = 0$ dBm		3.4		mA
$I_{TX,0dBm}$	TX only run current $P_{RF} = 0$ dBm		9.1		mA
$I_{TX,MINUS4dBm,DCDC}$	TX only run current DC/DC, 3 V, $P_{RF} = -4$ dBm		2.7		mA
$I_{TX,MINUS4dBm}$	TX only run current $P_{RF} = -4$ dBm		7.2		mA
$I_{TX,MINUS8dBm,DCDC}$	TX only run current DC/DC, 3 V, $P_{RF} = -8$ dBm		2.2		mA
$I_{TX,MINUS8dBm}$	TX only run current $P_{RF} = -8$ dBm		5.8		mA
$I_{TX,MINUS12dBm,DCDC}$	TX only run current DC/DC, 3 V, $P_{RF} = -12$ dBm		2.0		mA
$I_{TX,MINUS12dBm}$	TX only run current $P_{RF} = -12$ dBm		5.0		mA
$I_{TX,MINUS16dBm,DCDC}$	TX only run current DC/DC, 3 V, $P_{RF} = -16$ dBm		1.8		mA
$I_{TX,MINUS16dBm}$	TX only run current $P_{RF} = -16$ dBm		4.5		mA
$I_{TX,MINUS20dBm,DCDC}$	TX only run current DC/DC, 3 V, $P_{RF} = -20$ dBm		1.7		mA
$I_{TX,MINUS20dBm}$	TX only run current $P_{RF} = -20$ dBm		4.2		mA
$I_{TX,MINUS40dBm,DCDC}$	TX only run current DC/DC, 3 V, $P_{RF} = -40$ dBm		1.5		mA
$I_{TX,MINUS40dBm}$	TX only run current $P_{RF} = -40$ dBm		3.8		mA
$I_{START,TX,DCDC}$	TX start-up current DC/DC, 3 V, $P_{RF} = 4$ dBm		2.4		mA
$I_{START,TX}$	TX start-up current, $P_{RF} = 4$ dBm		5.4		mA

5.3.3. Radio Current Consumption (Receiver)

Symbol	Description	Min.	Typ.	Max.	Units
$I_{RX,1M,DCDC}$	RX only run current DC/DC, 3 V, 1 Mbps/1 Mbps Bluetooth LE mode		2.7		mA
$I_{RX,1M}$	RX only run current LDO, 3 V, 1 Mbps/1 Mbps Bluetooth LE mode		6.7		mA
$I_{RX,2M,DCDC}$	RX only run current DC/DC, 3 V, 2 Mbps/2 Mbps Bluetooth LE mode		3.1		mA
$I_{RX,2M}$	RX only run current LDO, 3 V, 2 Mbps/2 Mbps Bluetooth LE mode		7.9		mA
$I_{START,RX,1M,DCDC}$	RX start-up current DC/DC, 3 V, 1 Mbps/1 Mbps Bluetooth LE mode		2.1		mA
$I_{START,RX,1M}$	RX start-up current 1 Mbps/1 Mbps Bluetooth LE mode		5.3		mA

5.3.4. Transmitter Specification

Symbol	Description	Min.	Typ.	Max.	Units
P_{RF}	Maximum output power		3.0		dBm
P_{RFC}	RF power control range		23.0		dB
P_{RFCR}	RF power accuracy		± 2		dB
$P_{RF1,1}$	1st Adjacent Channel Transmit Power 1 MHz (1 Mbps)		-24		dBc
$P_{RF2,1}$	2nd Adjacent Channel Transmit Power 2 MHz (1 Mbps)		-52		dBc
$P_{RF1,2}$	1st Adjacent Channel Transmit Power 2 MHz (2 Mbps)		-25		dBc
$P_{RF2,2}$	2nd Adjacent Channel Transmit Power 4 MHz (2 Mbps)		-50		dBc
E_{vm}	Error vector magnitude in IEEE 802.15.4 mode		%rms
$P_{harm2nd, IEEE 802.15.4}$	2nd harmonics in IEEE 802.15.4 mode		-51		dBm
$P_{harm3rd, IEEE 802.15.4}$	3rd harmonics in IEEE 802.15.4 mode		-51		dBm
$P_{ACP,R, IEEE 802.15.4}$	IEEE 802.15.4 Relative adjacent Channel Power, offset > 3.5 MHz ¹¹		-36		dBc
$P_{ACP,A, IEEE 802.15.4}$	IEEE 802.15.4 Absolute adjacent Channel Power, offset > 3.5 MHz ¹¹		-36		dBm

5.3.5. RSSI Specifications

Symbol	Description	Min.	Typ.	Max.	Units
$RSSI_{ACC}$	RSSI accuracy		± 2		dB
$RSSI_{RESOLUTION}$	RSSI resolution		1		dB
$RSSI_{PERIOD}$	RSSI sampling time from <code>RSSI_START</code> task		0.25		μs
$RSSI_{SETTLE}$	RSSI settling time after signal level change		15		μs

5.3.6. Receiver Operation

Symbol	Description	Min.	Typ.	Max.	Units
P _{RX,MAX}	Maximum received signal strength at < 0.1% PER		0		dBm
P _{SENS,IT,1M}	Sensitivity, 1 Mbps nRF mode ideal transmitter ¹²		-95		dBm
P _{SENS,IT,2M}	Sensitivity, 2 Mbps nRF mode ideal transmitter ¹²		-92		dBm
P _{SENS,IT,SP,1M,BLE}	Sensitivity, 1 Mbps Bluetooth LE ideal transmitter, packet length ≤ 37 bytes BER = 1E-3 ¹³		-98		dBm
P _{SENS,IT,LP,1M,BLE}	Sensitivity, 1 Mbps Bluetooth LE ideal transmitter, packet length ≥ 128 bytes BER = 1E-4 ¹⁴		-97		dBm
P _{SENS,IT,SP,2M,BLE}	Sensitivity, 2 Mbps Bluetooth LE ideal transmitter, packet length ≤ 37 bytes		-95		dBm
P _{SENS,IT,BLE LE125k}	Sensitivity, 125 kbps Bluetooth LE mode		-104		dBm
P _{SENS,IT,BLE LE500k}	Sensitivity, 500 kbps Bluetooth LE mode		-100		dBm
P _{SENS,IEEE 802.15.4}	Sensitivity in IEEE 802.15.4 mode		-101		dBm

¹² Typical sensitivity applies when ADDR0 is used for receiver address correlation. When ADDR[1...7] are used for receiver address correlation, the typical sensitivity for this mode is degraded by 3 dB.

¹³ As defined in the *Bluetooth Core Specification v4.0 Volume 6: Core System Package (Low Energy Controller Volume)*.

¹⁴ Equivalent BER limit < 10E-04.

5.4. Application CPU Performance

Symbol	Description	Min.	Typ.	Max.	Units
W _{FLASH128}	CPU wait states, running CoreMark at 128 MHz from flash, cache disabled			4	
W _{FLASHCACHE128}	CPU wait states, running CoreMark at 128 MHz from flash, cache enabled			5	
W _{RAM128}	CPU wait states, running CoreMark at 128 MHz from RAM		0		
W _{FLASH64}	CPU wait states, running CoreMark at 64 MHz from flash, cache disabled			5	
W _{FLASHCACHE64}	CPU wait states, running CoreMark at 64 MHz from flash, cache enabled			6	
W _{RAM64}	CPU wait states, running CoreMark at 64 MHz from RAM		0		
CM _{FLASHCACHE128}	CoreMark, running from flash, cache enabled, HFXO128M		514		CoreMark
CM _{FLASH128/MHz}	CoreMark per MHz, running from flash, cache enabled, HFXO128M		4.0		CoreMark/MHz
CM _{FLASH128/mA}	CoreMark per mA, running from flash, cache enabled, DCDC 3V, HFXO128M		66		CoreMark/mA
CM _{FLASHCACHE64}	CoreMark, running from flash, cache enabled, HFXO64M		257		CoreMark
CM _{FLASH64/MHz}	CoreMark per MHz, running from flash, cache enabled, HFXO64M		4.0		CoreMark/MHz
CM _{FLASH64/mA}	CoreMark per mA, running from flash, cache enabled, DCDC 3V, HFXO64M		72.5		CoreMark/mA

5.5. Network CPU Performance

Symbol	Description	Min.	Typ.	Max.	Units
W _{FLASH}	CPU wait states, running from flash, cache disabled	0		4	
W _{FLASHCACHE}	CPU wait states, running from flash, cache enabled	0		5	
W _{RAM}	CPU wait states, running from RAM		0		
CM _{FLASHCACHE}	CoreMark, running from flash, cache enabled		244		CoreMark
CM _{FLASH/MHz}	CoreMark per MHz, running from flash, cache enabled		3.8		CoreMark/ MHz
CM _{FLASH/mA}	CoreMark per mA, running from flash, cache enabled		101		CoreMark/ mA

5.6. Power Management

5.6.1. Sleep

Symbol	Description	Min.	Typ.	Max.	Units
I _{ON_IDLE1}	System ON, 0 kB application RAM, wake on any event		1.3		uA
I _{ON_IDLE1,LDO}	System ON, 0k application RAM, wake on any event, regulator = LDO		3.3		uA
I _{ON_IDLE2}	System ON, wake on any event		1.3		uA
I _{ON_IDLE2,LDO}	System ON, wake on any event, regulator = LDO		3.4		uA
I _{ON_IDLE3}	System ON, wake on any event, power-fail comparator enabled		1.3		uA
I _{ON_IDLE3,128MHz}	System ON, wake on any event, power-fail comparator enabled, clock=HFINT128M		785		uA
I _{ON_IDLE4}	System ON, wake on GPIOTE input (event mode, LATENCY=LowLatency)		48		uA
I _{ON_IDLE4_LP}	System ON, wake on GPIOTE input (event mode, LATENCY=LowPower)		1.3		uA
I _{ON_IDLE5}	System ON, wake on GPIOTE PORT event		1.3		uA
I _{ON_IDLE6}	System ON, 0 kB application RAM, wake on RTC (running from LFXO clock)		1.5		uA
I _{ON_IDLE7}	System ON, wake on RTC (running from LFXO clock)		1.5		uA
I _{ON_IDLE8}	System ON, 0 kB application RAM, wake on RTC (running from LFXO clock), 5 V supply on VDDH, VREGH output = 3.3 V		1.7		uA
I _{ON_IDLE7}	System ON, 0 kB network RAM, wake on network RTC (running from LFXO clock)		1.5		uA
I _{ON_IDLE8}	System ON, 64 kB network RAM, wake on network RTC (running from LFXO clock)		1.7		uA

Symbol	Description	Min.	Typ.	Max.	Units
I _{ON_IDLE9}	System ON, 0 kB application RAM, wake on RTC (running from LFRC clock)		2.1		uA
I _{ON_IDLE10}	Both cores in System ON, wake on any event. VREQH=Disabled.		1.3		uA
I _{ON_IDLE10_VREQH}	Both cores in System ON, wake on any event. VREQH=Enabled.		1.4		uA
I _{OFF0}	System OFF, 0 kB application RAM, wake on reset		1.0		uA
I _{OFF0,LDO}	System OFF, 0 kB application RAM, wake on reset; regulator = LDO		1.4		uA
I _{OFF1}	System OFF, 0 kB application RAM, wake on LPCOMP		0.9		uA
I _{OFF2}	System OFF, wake on reset		0.9		uA
I _{OFF3}	System OFF, 0 kB application RAM, wake on reset, 5 V supply on VDDH, VREGH output = 3.3V		1.1		uA
I _{OFF3,LDO}	System OFF, 0 kB application RAM, wake on reset, 5 V supply on VDDH, VREGH output = 3.3V; regulator = LDO		1.4		uA
I _{OFF4}	System OFF, 512 kB application RAM + 64 kB network RAM, wake on reset		2.4		uA

5.6.2. Application CPU Running

Symbol	Description	Min.	Typ.	Max.	Units
I _{APPCPU0}	CPU running CoreMark from flash, regulator = LDO, clock = HFINT128M		15.5		mA
I _{APPCPU2}	CPU running CoreMark from flash, clock = HFXO128M		8.0		mA
I _{APPCPU3}	CPU running CoreMark from flash, clock = HFXO64M		3.6		mA
I _{APPCPU4}	CPU running CoreMark from flash, clock = HFINT128M		7.8		mA
I _{APPCPU5}	CPU running CoreMark from flash		3.3		mA
I _{APPCPU8}	CPU running CoreMark from RAM, clock = HFINT128M		7.9		mA
I _{APPCPU9}	CPU running CoreMark from RAM		3.4		mA
I _{APPCPU10}	CPU running CoreMark from RAM, clock = HFXO128M		8.2		mA
I _{APPCPU11}	CPU running CoreMark from RAM, clock = HFXO64M		3.6		mA

5.6.3. Network CPU Running

Symbol	Description	Min.	Typ.	Max.	Units
I _{NETCPU0}	CPU running CoreMark from flash, regulator = LDO		5.1		mA
I _{NETCPU1}	CPU running CoreMark from flash		2.4		mA
I _{NETCPU2}	CPU running CoreMark from flash, clock = HFXO64M		2.6		mA
I _{NETCPU3}	CPU running CoreMark from RAM, regulator = LDO		4.3		mA
I _{NETCPU4}	CPU running CoreMark from RAM		2.0		mA
I _{NETCPU5}	CPU running CoreMark from RAM, clock = HFXO64M		2.2		mA

5.6.4. I2S Active

Symbol	Description	Min.	Typ.	Max.	Units
I _{I2S0}	I2S transferring data @ 2 x 16 bit x 16 kHz (CONFIG.MCKFREQ = 32MDIV63, CONFIG.RATIO = 32X), clock = HFXO64M		2000		uA
I _{I2S1}	I2S transferring data @ 2 x 16 bit x 16 kHz (CONFIG.MCKFREQ = 510000, CONFIG.RATIO = 32X), clock = HFXO ACLK @ 12.288 MHz		2170		uA
I _{I2S2}	I2S transferring data @ 2 x 16 bit x 48 kHz (CONFIG.MCKFREQ = 505286656, CONFIG.RATIO = 32X), clock = HFXO ACLK @ 12.288 MHz		2310		uA

5.6.5. NFCT Active

Symbol	Description	Min.	Typ.	Max.	Units
I _{SENSE}	System ON, current in SENSE STATE (this current does not apply when in NFC field)		1.3		uA
I _{ACTIVATED}	System ON, current in ACTIVATED STATE, clock = HFXO64M		1080		uA

5.6.6. PDM Active

Symbol	Description	Min.	Typ.	Max.	Units
I _{PDM,RUN}	PDM receiving and processing data @ 1 Msps (RATIO = 64, PDMCLKCTRL = 135274496), stereo mode, clock = HFXO64M		655		uA
I _{PDM,RUN,ACLK}	PDM receiving and processing data @ 1 Msps (RATIO = 64, PDMCLKCTRL = 343597056), stereo mode, HFXO ACLK = 12.288 MHz		1045		uA

5.6.7. PWM Active

Symbol	Description	Min.	Typ.	Max.	Units
I _{PWM,RUN0}	PWM running at 125 kHz, top = 10, duty = 50%		560		uA
I _{PWM,RUN1}	PWM running at 16 MHz, top = 10, duty = 50%		560		uA
I _{PWM,RUN1,LDO}	PWM running at 16 MHz, top = 10, duty = 50%; regulator = LDO		1035		uA
I _{PWM,RUN2}	PWM running at 125 kHz, top = 10, duty = 50%, clock = HFXO64M		750		uA
I _{PWM,RUN3}	PWM running at 16 MHz, top = 10, duty = 50%, clock = HFXO64M		755		uA

5.6.8. QDEC Active

Symbol	Description	Min.	Typ.	Max.	Units
I _{QDEC,RUN}	QDEC running		480		uA

5.6.9. QSPI Active

Symbol	Description	Min.	Typ.	Max.	Units
I _{QSPI,IDLE}	QSPI idle (enabled, but not activated)		45		uA
I _{QSPI,ACTIVE}	QSPI active (activated, but not transferring data)		1790		uA
I _{QSPI,DATA}	QSPI transferring data (activated, and transferring data to/from external flash memory), SCKFREQ = 96 MHz, quad mode, clock = HFXO192M		4430		uA

5.6.10. SAADC Active

Symbol	Description	Min.	Typ.	Max.	Units
I _{SAADC,RUN}	SAADC sampling @ 16 ksps, acquisition time = 20 us, clock = HFXO64M		980		uA
I _{SAADC,TASK}	SAADC sampling @ 1 kHz from RTC in task mode, acquisition time = 20 us, clock = HFINT64M and LFXO		160		uA

5.6.11. Timer Running

Symbol	Description	Min.	Typ.	Max.	Units
I _{TIMER0}	One TIMER running @ 1 MHz		475		uA
I _{TIMER1}	One TIMER running @ 1 MHz, clock = HFXO64M		670		uA
I _{TIMER2}	One TIMER running @ 16 MHz		560		uA
I _{TIMER2,LDO}	One TIMER running @ 16 MHz; regulator = LDO		1040		uA
I _{TIMER3}	One TIMER running @ 16 MHz, clock = HFXO64M		750		uA
I _{TIMER3,LDO}	One TIMER running @ 16 MHz, clock = HFXO64M; regulator LDO		1280		uA
I _{TIMER4}	One TIMER running @ 16 MHz, clock = HFINT128M		750		uA
I _{NET,TIMER0}	One network TIMER running @ 1 MHz		170		uA
I _{NET,TIMER1}	One network TIMER running @ 1 MHz, clock = HFXO64M		400		uA
I _{NET,TIMER2}	One network TIMER running @ 16 MHz		220		uA
I _{NET,TIMER3}	One network TIMER running @ 16 MHz, clock = HFXO64M		445		uA

5.6.12. SPIM Active

Symbol	Description	Min.	Typ.	Max.	Units
I _{SPIM0}	SPIM transferring data @ 2 Mbps		935		uA
I _{SPIM1}	SPIM transferring data @ 2 Mbps, clock = HFXO64M		1145		uA
I _{SPIM2}	SPIM transferring data @ 8 Mbps		1705		uA
I _{SPIM3}	SPIM transferring data @ 8 Mbps, clock = HFXO64M		1930		uA
I _{SPIM4}	SPIM transferring data @ 32 Mbps		2115		uA
I _{SPIM5}	SPIM transferring data @ 32 Mbps, clock = HFXO64M		2345		uA

5.6.13. SPIS Active

Symbol	Description	Min.	Typ.	Max.	Units
I _{SPIS0}	SPIS configured and idle (enabled, no CSN activity)		145		uA
I _{SPIS1}	SPIS transferring data @ 2 Mbps		713		uA
I _{SPIS2}	SPIS transferring data @ 2 Mbps, clock = HFXO64M		913		uA

5.6.14. TWIM Active

Symbol	Description	Min.	Typ.	Max.	Units
I _{TWIM0}	TWIM transferring data @ 100 kbps		965		uA
I _{TWIM1}	TWIM transferring data @ 100 kbps, clock = HFXO64M		1170		uA
I _{TWIM2}	TWIM transferring data @ 400 kbps		1000		uA
I _{TWIM3}	TWIM transferring data @ 400 kbps, clock = HFXO64M		1205		uA
I _{TWIM4}	TWIM transferring data @ 1000 kbps		2050		uA
I _{TWIM5}	TWIM transferring data @ 1000 kbps, clock = HFXO64M		2295		uA

5.6.15. TWIS Active

Symbol	Description	Min.	Typ.	Max.	Units
I _{TWIS,IDLE}	TWIS configured and enabled (IDLE state)		45		uA
I _{TWIS0}	TWIS transferring data @ 100 kbps		945		uA
I _{TWIS1}	TWIS transferring data @ 400 kbps		985		uA
I _{TWIS2}	TWIS transferring data @ 100 kbps, clock = HFXO64M		1150		uA
I _{TWIS3}	TWIS transferring data @ 400 kbps, clock = HFXO64M		1185		uA

5.6.16. UARTE Active

Symbol	Description	Min.	Typ.	Max.	Units
I _{UARTE,IDLE0}	UARTE RX idle (started, waiting for data, no data transfer)		645		uA
I _{UARTE,IDLE1}	UARTE RX idle (started, waiting for data, no data transfer), clock = HFXO64M		840		uA
I _{UARTE0}	UARTE transferring data @ 1200 bps, clock = HFXO64M		885		uA
I _{UARTE1}	UARTE transferring data @ 115200 bps, clock = HFXO64M		890		uA
I _{UARTE2}	UARTE receiving data @ 115200 bps, clock = HFXO64M		890		uA
I _{UARTE3}	UARTE transmitting and receiving data @ 115200 bps, clock = HFXO64M		895		uA

5.6.17. USBD Active

Symbol	Description	Min.	Typ.	Max.	Units
$I_{USB,ACTIVE,VBUS}$	Current from VBUS supply, USB active		1.2		mA
$I_{USB,SUSPEND,VBUS}$	Current from VBUS supply, USB suspended, CPU sleeping		180		μ A
$I_{USB,ACTIVE,VDD}$	Current from VDD supply (normal voltage mode), all RAM retained, CPU running, USB active		3.0		mA
$I_{USB,SUSPEND,VDD}$	Current from VDD supply (normal voltage mode), all RAM retained, CPU sleeping, USB suspended		815		μ A
$I_{USB,SUSPEND,VDD,LDO}$	Current from VDD supply (normal voltage mode), all RAM retained, CPU sleeping, USB suspended, regulator = LDO		135		μ A
$I_{USB,ACTIVE,VDDH}$	Current from VDDH supply (high voltage mode), VDD=3 V (VREGH output), all RAM retained, CPU running, USB active		3.2		mA
$I_{USB,SUSPEND,VDDH}$	Current from VDDH supply (high voltage mode), VDD=3 V (VREGH output), all RAM retained, CPU sleeping, USB suspended		2340		μ A
$I_{USB,SUSPEND,VDDH,LDO}$	Current from VDDH supply (high voltage mode), VDD=3 V (VREGH output), all RAM retained, CPU sleeping, USB suspended, regulator = LDO		125		μ A
$I_{USB,DISABLED,VDD}$	Current from VDD supply, USB disabled, VBUS supply connected, all RAM retained, CPU sleeping		3		μ A

6. Block Diagram

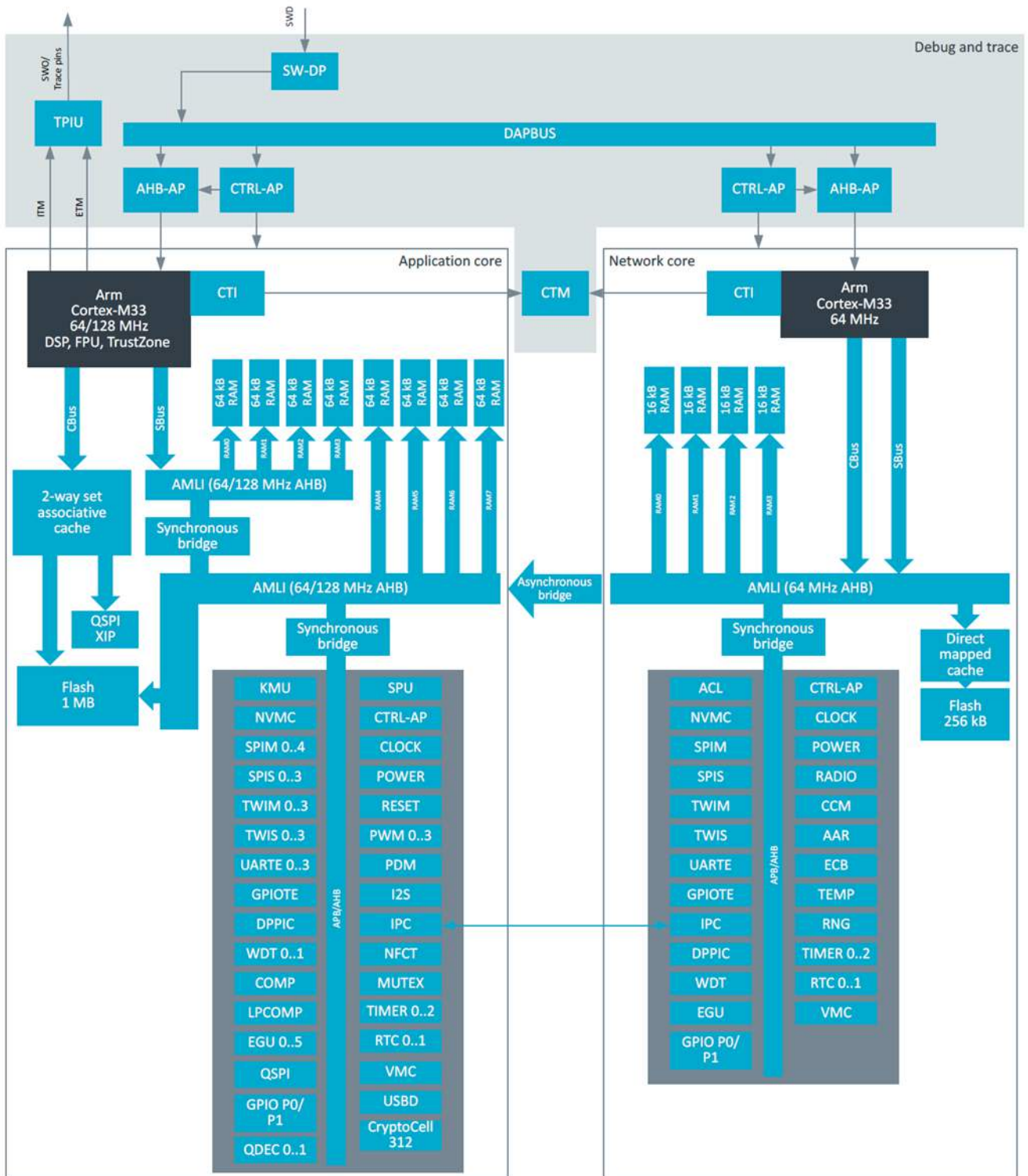

7. Antenna

7.1. MDBT53

Antenna Gain and Efficiency

Test Result											
Frequency (MHz)	2400	2410	2420	2430	2440	2450	2460	2470	2480	2490	2500
Gain (dBi)	-0.98	-0.74	-0.67	-0.62	-0.74	-0.81	-0.63	-0.45	-0.39	-0.46	-0.64
Peak EIRP (dBm)	-0.98	-0.74	-0.67	-0.62	-0.74	-0.81	-0.63	-0.45	-0.39	-0.46	-0.64
Directivity (dBi)	5.82	5.76	5.65	5.64	5.50	5.40	5.59	5.85	6.11	6.35	6.57

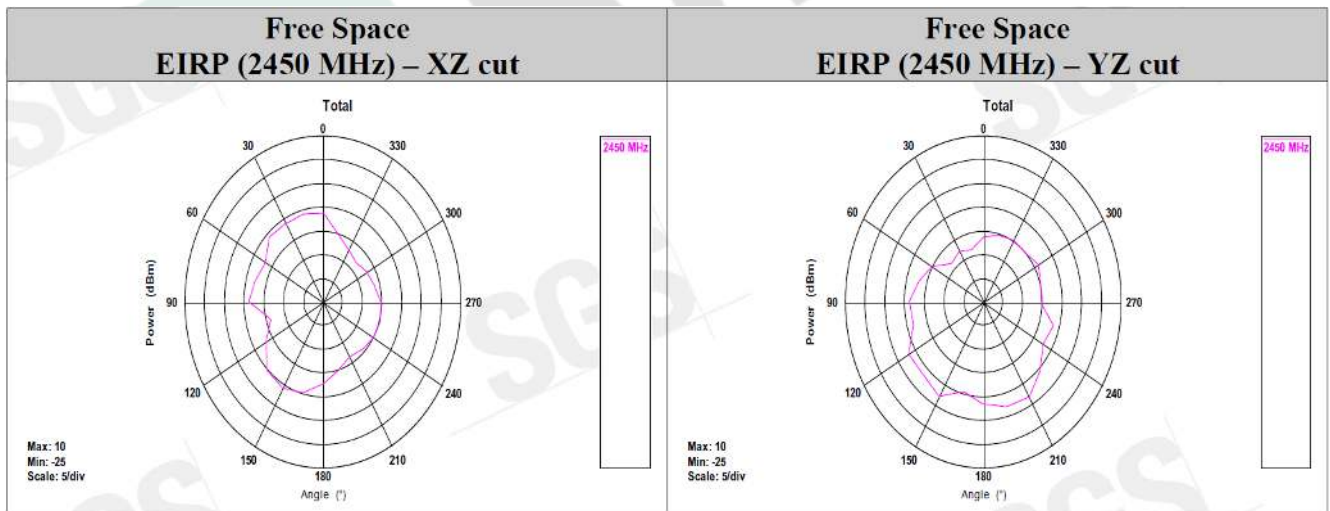
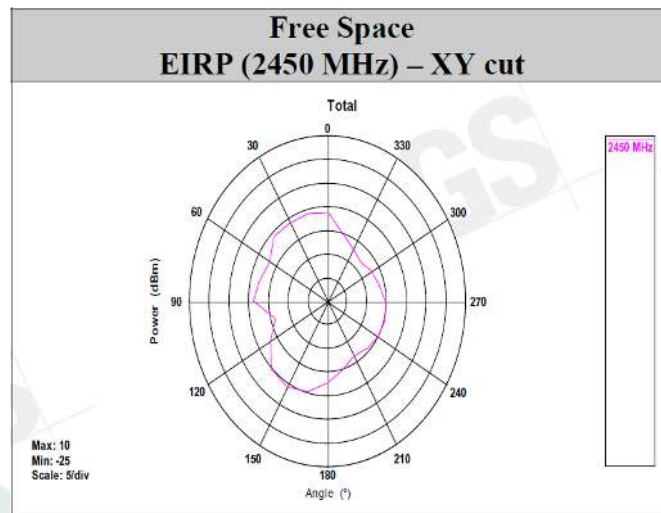

7.2. MDBT53-P

Antenna Gain and Efficiency

Test Result											
Frequency (MHz)	2400	2410	2420	2430	2440	2450	2460	2470	2480	2490	2500
Gain (dBi)	-2.32	-2.82	-2.88	-2.98	-3.15	-3.43	-3.39	-3.15	-2.83	-2.65	-2.53
Peak EIRP (dBm)	-2.32	-2.82	-2.88	-2.98	-3.15	-3.43	-3.39	-3.15	-2.83	-2.65	-2.53
Directivity (dBi)	5.17	4.75	4.79	4.71	4.49	4.10	4.12	4.42	4.98	5.49	5.97

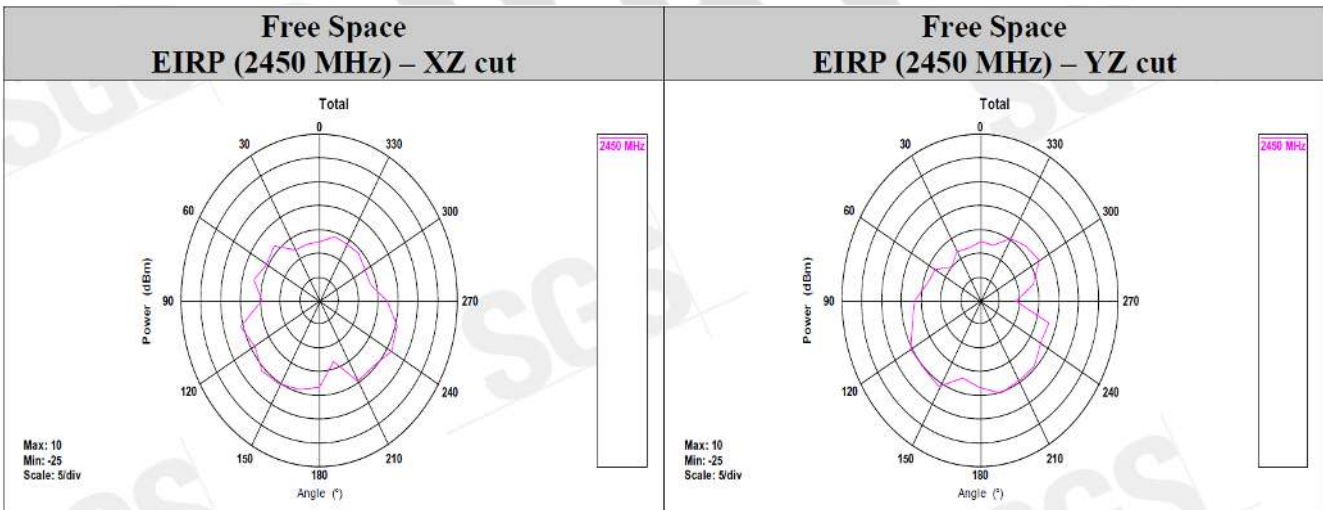
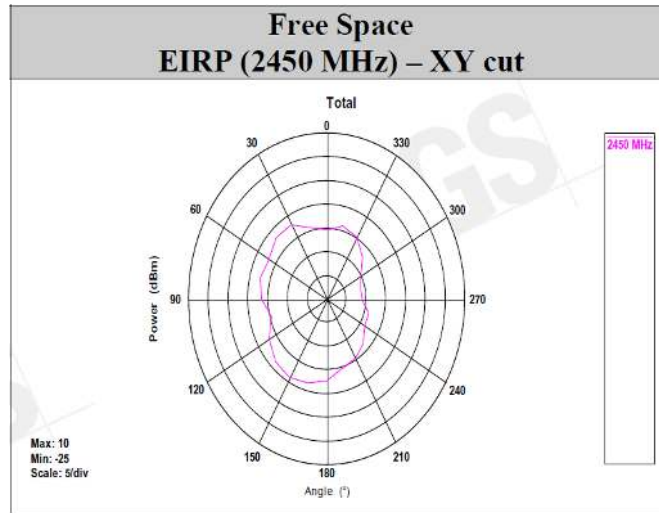

8.1.2. DC/DC Mode

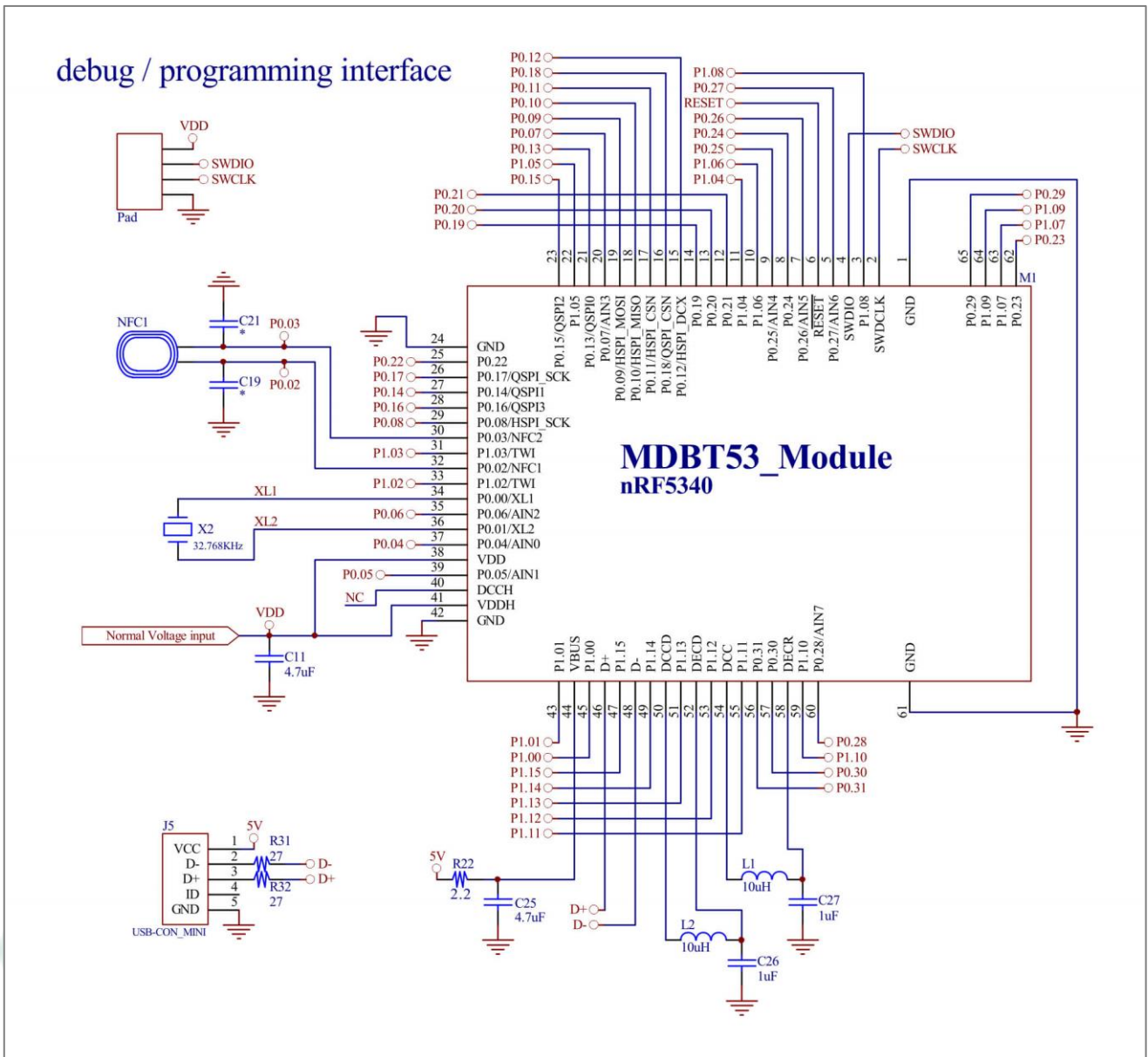

8.2. High Voltage LDO and DC/DC Mode

Recommend using when the highest input voltage is equal or greater than 3.6V. Supply power from VDDH.

8.2.1. LDO Mode

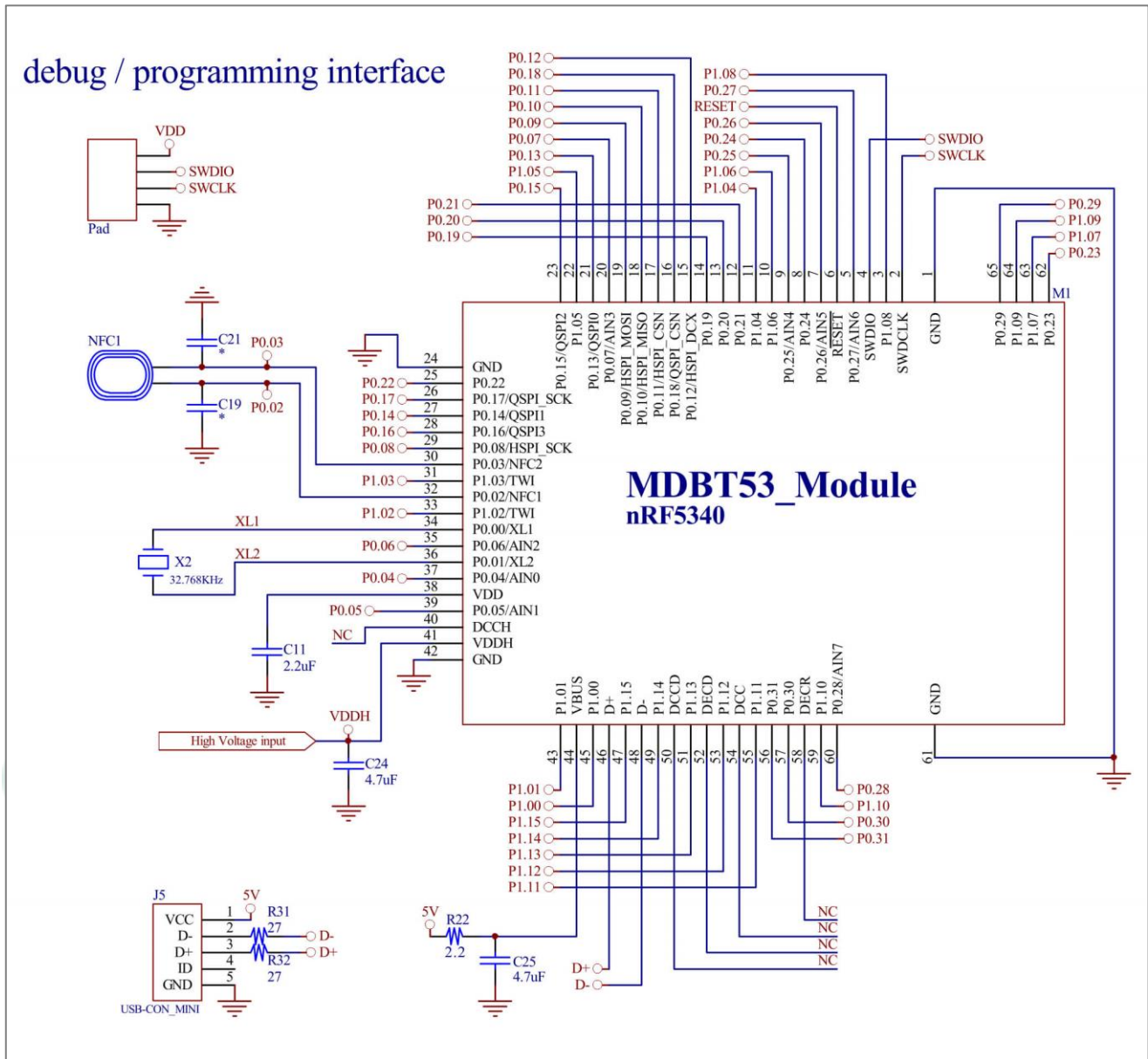

8.2.2. DC/DC Mode

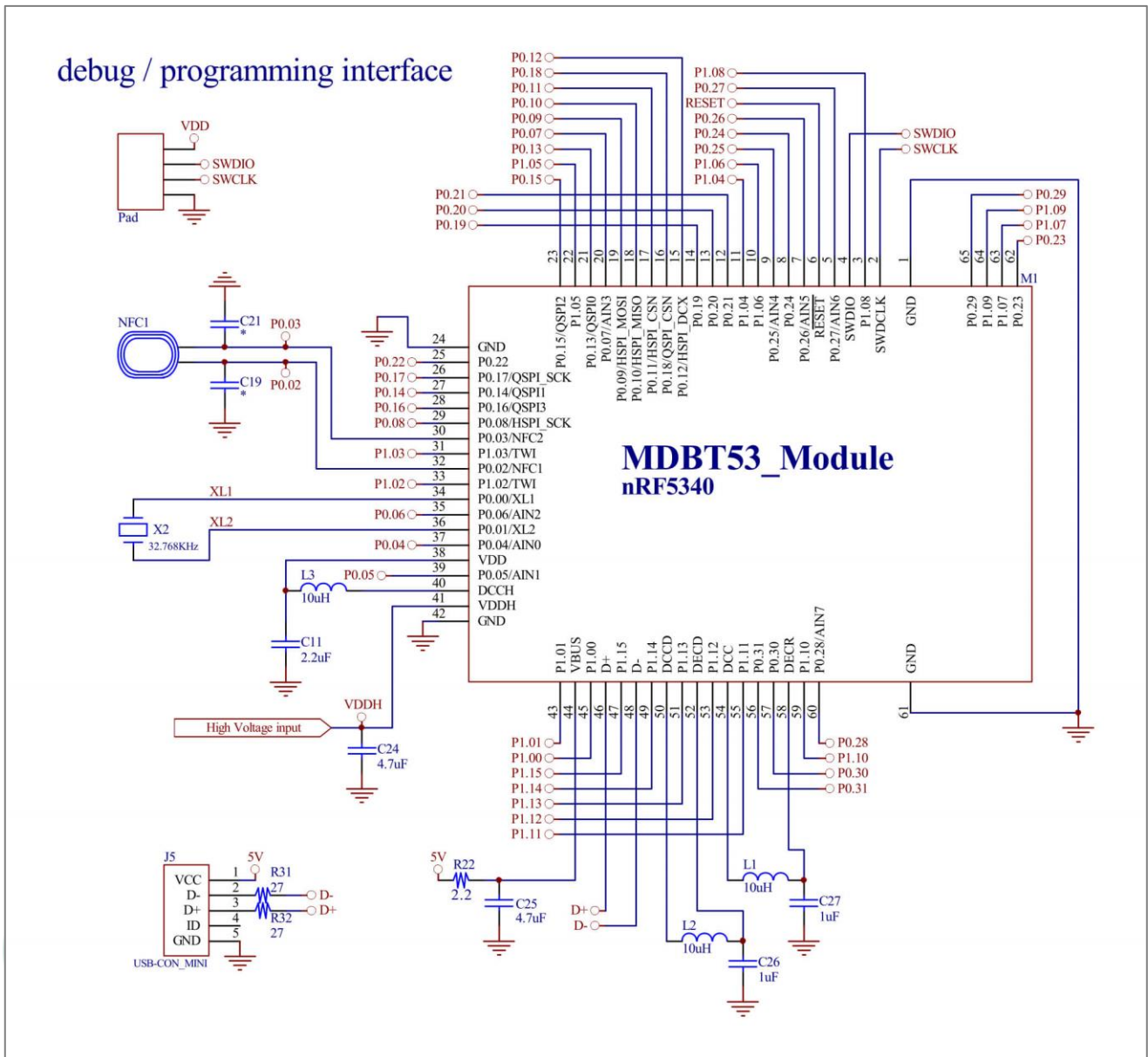

8.3. USB Power LDO and DC/DC Mode

Recommend using when the device is powered by USB.

8.3.1. LDO Mode

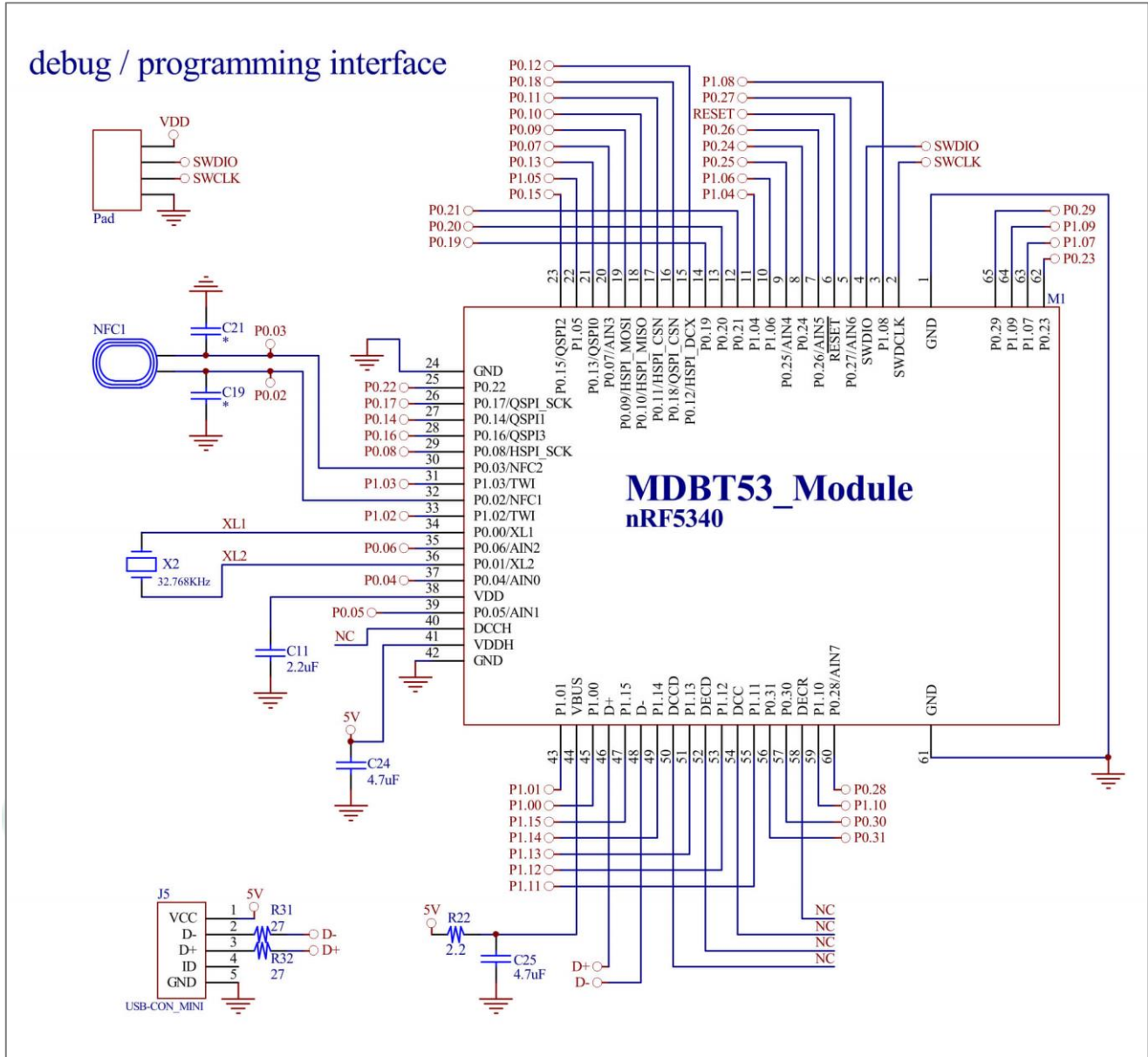

8.3.2. DC/DC Mode

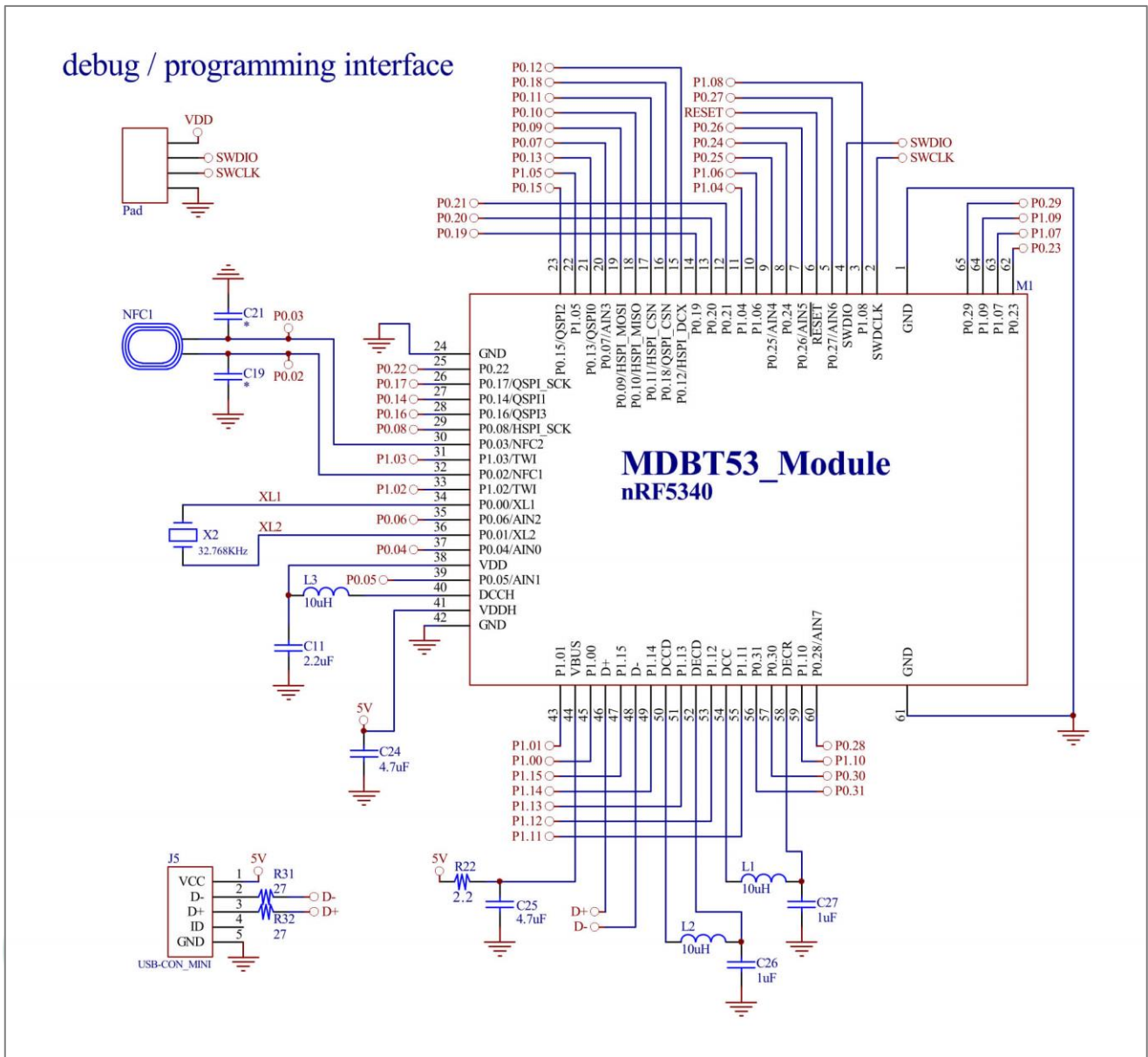

9. Certification

9.1. Declaration ID

Declaration ID	QDID(s)	Company	Specification Name
D056376	170219 - Controller Subsystem 157450 - Host Subsystem	Raytac Corporation	5.2

Profile Description	Service Description
Alert Notification Profile	Alert Notification Service
Blood Pressure Profile	Blood Pressure Service
	Device Information Service
Cycling Speed & Cadence Profile	Cycling Speed & Cadence Service
	Device Information Service
Glucose Profile	Glucose Service
	Device Information Service
Health Thermometer Profile	Health Thermometer Service
	Device Information Service
Heart Rate Profile	Heart Rate Service
	Device Information Service
HID over GATT Profile	HID Service
	Battery Service
Proximity Profile	Link Loss Service
	Immediate Alert Service
	TX Power Service
Running Speed & Cadence Profile	Running Speed & Cadence Service
	Device Information Service
Time Profile	Time Profile Service
Glucose Profile (Central)	
Mesh Profile	Mesh Provisioning Service
	Mesh Proxy Service

9.2. FCC Certificate (USA)

BLE 1 Mbps & 2 Mbps



TCB

**GRANT OF EQUIPMENT
AUTHORIZATION**

Certification
Issued Under the Authority of the
Federal Communications Commission
By:

TCB

Telefication B.V.
Wilmersdorf 50
Apeldoorn, NL-7300 AC
Netherlands

Date of Grant: 11/24/2021

Application
Dated: 11/16/2021

Raytac Corp.
5F., No.3, Jiankang Rd., Zhonghe Dist.,
New Taipei City,, 23586
Taiwan

Attention: Venson Liao , R&D Manager

NOT TRANSFERABLE

EQUIPMENT AUTHORIZATION is hereby issued to the named
GRANTEE, and is VALID ONLY for the equipment identified hereon for
use under the Commission's Rules and Regulations listed below.

FCC IDENTIFIER:	SH6MDBT53		
Name of Grantee:	Raytac Corp.		
Equipment Class:	Digital Transmission System		
Notes:	Bluetooth Module		
Modular Type:	Single Modular		

Grant Notes	FCC Rule Parts	Frequency Range (MHZ)	Output Watts	Frequency Emission Tolerance Designator
	15C	2402.0 - 2480.0	0.002	

Modular Approval. Power output listed is conducted. This grant is valid only when the module is sold to OEM integrators and must be installed by the OEM or OEM integrators. The antennas used for this transmitter as shown in this filing must not be co-located or operating in conjunction with any other antenna or transmitter. End-users may not be provided with the module installation instructions. OEM integrators and end-users must be provided with transmitter operating conditions for satisfying RF exposure compliance.

Certificate No.:
212181441/AA/00

George Lo
Product Assessor



9.3. TELEC Certificate (Japan)

BLE 1 Mbps & 2 Mbps

telefication bv
The Netherlands
Chamber of Commerce
51565536
www.telefication.com

 telefication

Certificate
of
Radio Equipment in JAPAN
No: 201-210873 / 00

Telefication, operating as Conformity Assessment Body (CAB ID Number: 201) with respect to Japan, declares that the listed product complies with the Technical Regulations Conformity Certification of Specified Radio equipment (ordinance of MPT N° 37,1981)

Product description: **Bluetooth Module**
Trademark: **Raytac Corporation**
Type designation: **MDBT53**
Hardware / Software version: 1 / 1
Variants: **See Annex 3**

Manufacturer: **Raytac Corporation**
Address: **5F, No. 3, Jiakang Rd., Zhonghe Dist.**
City: **23586 New Taipei City**
Country: **Taiwan**

This certificate is granted to:

Name: **Raytac Corporation**
Address: **5F, No. 3, Jiakang Rd., Zhonghe Dist.**
City: **23586 New Taipei City**
Country: **Taiwan**

This certificate has THREE Annexes.

Apeldoorn, 17 November 2021

CAB

David Chen
David Chen
Product Assessor

 PRODUCTS
RvA C 224

9.4. NCC Certificate (Taiwan)

BLE 1 Mbps & 2 Mbps

MDBT53

SGS

台灣檢驗科技股份有限公司
電信管制射頻器材型式認證證明

證照字號：型式字第 AM 號

- 一、申請者：勁達國際電子有限公司
- 二、地址：臺北市大安區和平東路1段145號5樓之1
- 三、製造廠商：勁達國際電子有限公司
- 四、器材名稱：藍牙模組
- 五、廠牌：Raytac Corporation
- 六、型號：MDBT53
- 七、發射功率(電場強度)：詳細射頻規格如備註欄
- 八、工作頻率：詳細射頻規格如備註欄
- 九、審驗日期：110年12月15日

十、審驗合格標籤式樣：



- 十一、警語或標示要求：(器材本體、使用手冊、外包裝盒等應遵守下列標示要求)
1. 應於本體明顯處標示審驗合格標籤或符合性聲明標籤及其型號，並於包裝盒標示主管機關印章。最終產品應於本體明顯處標示非隨插即用射頻模組(組件)之審驗合格標籤及最終產品型號，並於包裝盒標示主管機關印章，始得販賣。
 2. 依主管機關或相關技術規範規定於指定位置標示正體中文警語。
 3. 經授權使用射頻模組(組件)之審驗合格標籤者，應於最終產品說明書及包裝盒提供充分與正確之資訊。
 4. 於網際網路販賣電信管制射頻器材者，應於該網際網路網頁標示其型號及審驗合格標籤或符合性聲明標籤資訊。但最終產品得僅標示其型號及其組裝之非隨插即用射頻模組(組件)之審驗合格標籤資訊。
 5. 使用手冊應標示下列資訊：
 - (1) 取得審驗證明之低功率射頻器材，非經核准，公司、商號或使用者均不得擅自變更頻率、加大功率或變更原設計之特性及功能。低功率射頻器材之使用不得影響飛航安全及干擾合法通信；經發現有干擾現象時，應立即停用，並改善至無干擾時方得繼續使用。前述合法通信，指依電信管理法規定作業之無線電通信。低功率射頻器材須忍受合法通信或工業、科學及醫療用電波輻射性電機設備之干擾。

BLE 1 Mbps & 2 Mbps

MDBT53-P



台灣檢驗科技股份有限公司 電信管制射頻器材型式認證證明

證照字號：型式字第 AM 號

- 一、申請者：勁達國際電子有限公司
- 二、地址：臺北市大安區和平東路1段145號5樓之1
- 三、製造廠商：勁達國際電子有限公司
- 四、器材名稱：藍牙模組
- 五、廠牌：Raytac Corporation
- 六、型號：MDBT53-P
- 七、發射功率(電場強度)：詳細射頻規格如備註欄
- 八、工作頻率：詳細射頻規格如備註欄
- 九、審驗日期：110年12月15日

- 十、審驗合格標籤式樣：

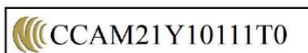



- 十一、警語或標示要求：(器材本體、使用手冊、外包裝盒等應遵守下列標示要求)

1. 應於本體明顯處標示審驗合格標籤或符合性聲明標籤及其型號，並於包裝盒標示主管機關標章。最終產品應於本體明顯處標示非隨插即用射頻模組(組件)之審驗合格標籤及最終產品型號，並於包裝盒標示主管機關標章，始得販賣。
2. 依主管機關或相關技術規範規定於指定位置標示正體中文警語。
3. 經授權使用射頻模組(組件)之審驗合格標籤者，應於最終產品說明書及包裝盒提供充分與正確之資訊。
4. 於網際網路販賣電信管制射頻器材者，應於該網際網路網頁標示其型號及審驗合格標籤或符合性聲明標籤資訊。但最終產品得僅標示其型號及其組裝之非隨插即用射頻模組(組件)之審驗合格標籤資訊。
5. 使用手冊應標示下列資訊：
 - (1) 取得審驗證明之低功率射頻器材，非經核准，公司、商號或使用者均不得擅自變更頻率、加大功率或變更原設計之特性及功能。低功率射頻器材之使用不得影響飛航安全及干擾合法通信；經發現有干擾現象時，應立即停用，並改善至無干擾時方得繼續使用。前述合法通信，指依電信管理法規定作業之無線電通信。低功率射頻器材須忍受合法通信或工業、科學及醫療用電波輻射性電機設備之干擾。

9.5. CE (EU) & RCM (Australia & New Zealand) Test Report

BLE 1 Mbps & 2 Mbps

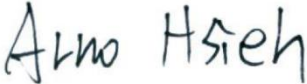
	Report No.: E2/2021/A0098 Page: 1 of 88
ETSI EN 300 328 v2.2.2 : 2019 TEST REPORT	 
Applicant:	Raytac Corporation 5F., No.3, Jiankang Road, Zhonghe District, New Taipei City 23586, Taiwan
Product Name:	Bluetooth Module
Brand Name:	Raytac Corporation
Model No.:	MDBT53, MDBT53-P, MDBT53-U
Model Difference:	Different Antenna Type
Report Number:	E2/2021/A0098
Issue Date:	Nov. 11, 2021
Date of Test:	Oct. 18, 2021~Oct. 29, 2021
Date of EUT Received:	Oct. 14, 2021
Approved By	 <u>Arno Hsieh</u>
We hereby certify that:	The above equipment was tested by SGS Taiwan Ltd., Central RF Lab for compliance with the requirements set forth in the European Standard ETSI EN 300 328 v2.2.2: 2019 under 2014/53/EU. The results of testing in this report apply to the product system that was tested only. Other similar equipment will not necessarily produce the same results due to production tolerance and measurement uncertainties.

VERIFICATION OF COMPLIANCE

Issue Date: Nov. 18, 2021
Applicant: Raytac Corporation
Address: 5F., No.3, Jiankang Road, Zhonghe District, New Taipei City 23586, Taiwan
Manufacturer: Raytac Corporation
Address: 5F., No.3, Jiankang Road, Zhonghe District, New Taipei City 23586, Taiwan
Contact Information: Web: www.raytac.com
TEL#: +886-2-3234-0208
E-mail#: service@raytac.com
Product: Bluetooth Module
Brand Name/Trade Mark: Raytac Corporation
Model/Type: MDBT53
Added Model(s): MDBT53-P, MDBT53-U
Applicable Standards: EN 301 489 –1 v2.2.3 : 2019-11
EN 301 489 –17 v3.2.4 : 2020-09
EN 55032 : 2015+A11:2020
EN 61000-4-2 : 2009
EN 61000-4-3 : 2006+A1:2008+A2:2010
Test Laboratory: SGS Taiwan Ltd.
Electromagnetic Compatibility Laboratory
No.2, Keji 1st Rd., Guishan District, Taoyuan City, Taiwan
Test Report No.: TMHY2110000441YE, dated on Nov. 18, 2021

Conclusion: Based upon a review of the Test Report(s), the tested sample of the product mentioned above is deemed to comply with the requirements of the above standards.

Note: This verification is only valid for the product and configuration described and in conjunction with the test report as detailed above.

Authorised Signatory:



SGS Taiwan Ltd.
Eddy Cheng
Assistant Supervisor

AS/NZS 4268:2017
EN 300 328 v2.2.2: 2019
TEST REPORT



Applicant: Raytac Corporation
5F., No.3, Jiankang Road, Zhonghe District, New Taipei City
23586, Taiwan

Product Name: Bluetooth Module

Brand Name: Raytac Corporation

Model No.: MDBT53, MDBT53-P, MDBT53-U

Model Difference: Different Antenna Type

Report Number: E2/2021/A0100

Issue Date: Nov. 11, 2021

Date of Test: Oct. 14, 2021~Oct. 29, 2021

Date of EUT Received: Oct. 14, 2021

Approved By



Arno Hsieh

We hereby certify that:

The above equipment was tested by SGS Taiwan Ltd., Central RF Lab for compliance with the requirements set forth in the European Standard ETSI EN 300 328 v2.2.2: 2019 under RED 2014/53/EU and Australian/New Zealand Standard AS/NZS 4268:2017, Row 59. Test report to determine compliance with AS/NZS 4268 requirements. The results of testing in this report apply to the product system that was tested only. Other similar equipment will not necessarily produce the same results due to production tolerance and measurement uncertainties.

9.6. IC Certificate (Canada)

BLE 1 Mbps & 2 Mbps

<p>telefication bv The Netherlands Chamber of Commerce 51565536 www.telefication.com</p>		
<p>TECHNICAL ACCEPTANCE CERTIFICATE</p>	<p>CERTIFICAT D'ACCEPTABILITÉ TECHNIQUE</p>	
<p>CERTIFICATION No. No. DE CERTIFICATION</p>	<p>8017A-MDBT53</p>	
<p>TELEFICATION No. No. DE TELEFICATION</p>	<p>212170506/AA/00</p>	
<p>TEST SITE No. No. DE LABORATOIRE</p>	<p>TW3702</p>	
<p>ISSUED TO DÉLIVRÉ A</p>	<p>Raytac Corp. 5F., No.3, Jiankang Road, New Taipei City 23586 Taiwan</p>	
<p>TYPE OF EQUIPMENT GENRE DE MATÉRIEL</p>	<p>Bluetooth device</p>	
<p>TRADE NAME AND MODEL MARQUE ET MODELE</p>	<p>Raytac Corporation / MDBT53 Raytac Corporation / MDBT53-P Raytac Corporation / MDBT53-U</p>	
<p>CERTIFIED TO CERTIFIÉ SELON LE</p>	<p>SPECIFICATION CAHIER DES CHARGES</p>	<p>RSS-102 RSS-247</p>
		<p>ISSUE EDITION</p>
		<p>5 2</p>
<p>Certification of equipment means only that the equipment has met the requirements of the above-noted specification. Licence applications, where applicable to use certified equipment, are acted on accordingly by the ISED issuing office and will depend on the existing radio environment, service and location of operation. This certificate is issued on condition that the holder complies and will continue to comply with the requirements and procedures issued by ISED. The equipment for which this certificate is issued shall not be manufactured, imported, distributed, leased, offered for sale or sold unless the equipment complies with the applicable technical specifications and procedures issued by ISED.</p>		
<p>La certification du matériel signifie seulement que le matériel a satisfait aux exigences de la norme indiquée ci-dessus. Les demandes de licences nécessaires pour l'utilisation du matériel certifié sont traitées en conséquence par le bureau de délivrance d'ISDE et dépendent des conditions radio ambiantes, du service et de l'emplacement d'exploitation. Le présent certificat est délivré à la condition que le titulaire satisfasse et continue de satisfaire aux exigences et aux procédures d'ISDE. Le matériel à l'égard duquel le présent certificat est délivré ne doit pas être fabriqué, importé, distribué, loué, mis en vente ou vendu à moins d'être conforme aux procédures et aux spécifications techniques applicables publiées par ISDE.</p>		
<p>ISSUED BY TELEFICATION BV (NL0001), RECOGNIZED CERTIFICATION BODY BY INNOVATION, SCIENCE AND ECONOMIC DEVELOPMENT CANADA, ACCORDING THE CANADIAN CERTIFICATION BODY SCHEME (CB 02). DÉLIVRÉ PAR TELEFICATION BV (NL0001), ORGANISME DE CERTIFICATION RECONNU PAR INNOVATION, SCIENCES ET DÉVELOPPEMENT ÉCONOMIQUE CANADA, SELON LE SYSTÈME D'ORGANISME DE CERTIFICATION DE CANADA (CB-02).</p>		
<p><i>I hereby attest that the subject equipment was tested and found in compliance with the above-noted specification. J'atteste, par la présente, que le matériel a fait l'objet d'essai et a été jugé conforme à la spécification ci-dessus</i></p>		
<p>DATE 24 Nov 2021 BY</p>	<p>George Lo Product Assessor</p>	
<p>This certificate has one annex.</p>	 	

9.7. SRRC Certificate (China)

BLE 1 Mbps & 2 Mbps

无线电发射设备
Radio Transmission Equipment
型号核准证
Type Approval Certificate

劲达国际电子有限公司（台湾）：

根据《中华人民共和国无线电管理条例》
In accordance with the provisions on the Radio
Regulations of the People's Republic of China , the following
符合中华人民共和国无线电管理规定和
radio transmission equipment , after examination , conforms
技术标准，其核准代码为：CMIIT ID: 2022DJ1251
to the provisions with its CMIIT ID:

有效期： 2025-12-31
Validity

(发证机关)
Sealed by issuing authority

202年 01 月 28 日
Year Month Date

9.8. KC Certificate (South Korea)

BLE 1 Mbps & 2 Mbps

BC41-8F5E-315A-4C38

방송통신기자재등의 적합인증서 Certificate of Broadcasting and Communication Equipments	
상호 또는 성명 <small>Trade Name or Applicant</small>	Raytac Corporation
기자재명칭 <small>Equipment Name</small>	특정소출력 무선기기(무선데이터통신시스템용 무선기기)
기본모델명 <small>Basic Model Number</small>	MDBT53-U
기기부호/추가 기기부호 <small>Equipment code /Additional Equipment code</small>	LARN8
파생모델명 <small>Series Model Number</small>	MDBT53-P, MDBT53
인증번호 <small>Certification No.</small>	R-C-ryt-MDBT53-U
제조사/제조국가 <small>Manufacturer /Country of Origin</small>	Raytac Corporation / 대만
인증연월일 <small>Date of Certification</small>	2021-12-22
기타 <small>Others</small>	
위 기자재는 「전파법」 제58조의2 제2항에 따라 인증되었음을 증명합니다. It is verified that foregoing equipment has been certificated under the Clause 2, Article 58-2 of Radio Waves Act.	
2022년(Year) 01월(Month) 04일(Day)	
국립전파연구원장 	
Director General of National Radio Research Agency	
※ 인증 받은 방송통신기자재는 반드시 "적합성평가표시" 를 부착하여 유통하여야 합니다. 위반시 과태료 처분 및 인증이 취소될 수 있습니다.	

9.9. RoHS & REACH Report

Please visit "[Support](#)" page of our website to download.

9.10. End-Product Label

It is suggested using following content adding to package or user manual or label to obey the regulation. Any rules of end-product label shall refer to each regulation for final reference.

9.10.1. FCC (USA)

The FCC statement should be included in the user manual when there is no enough space on label. Otherwise, it should be included on the label.

"This device complies with part 15 of the FCC rules. Operation is subject to the following two conditions. (1) This device may not cause harmful interference. (2) This device must accept any interference received, including interference that may cause undesired operation."

The final end product must be labeled in a visible area with the following: "Contain FCC ID: SH6MDBT53".

9.10.2. TELEC (Japan)

When manufacturer is placing the product on the Japanese market, the product must be affixed with the following Specified Radio Equipment marking:

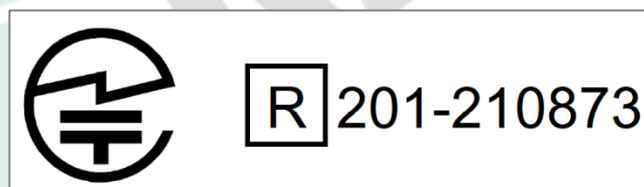

9.10.3. NCC (Taiwan)

請依下列標籤式樣自製標籤，標貼或印鑄於器材本體明顯處，始得販賣或公開陳列。

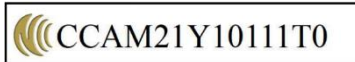
Series	標籤樣式
MDBT53 Series	
MDBT53-P Series	

以 MDBT53 為例，平台廠商必須於平台上標示字樣「本產品內含射頻模組：ID 編號 CCAM21Y10110T8」。

「平台」定義如下：若器材組裝本案模組，消費者仍能正常使用該器材主要功能，該器材得視為平台。若器材不組裝本案模組，消費者不能正常使用該器材主要功能，該器材不能視為平台。

該類不同廠牌型號器材組裝本案審驗模組後，須分別申請型式認證。

9.10.4. IC (Canada)

The IC statement should be included in the user manual when there is no enough space on label. Otherwise, it should be included on the label.

“This device complies with Industry Canada license-exempt RSS Standard(s). Operation is subject to the following two conditions. (1) This device may not cause harmful interference. (2) This device must accept any interference received, including interference that may cause undesired operation.

Le présent appareil est conforme aux CNR d'Industrie Canada applicables aux appareils radio exempts de licence. L'exploitation est autorisée aux deux conditions suivantes: (1) l'appareil ne doit pas produire de brouillage, et (2) l'utilisateur de l'appareil doit accepter tout brouillage radioélectrique subi, même si le brouillage est susceptible d'en compromettre le fonctionnement.”

The final end product must be labeled in a visible area with the following: “Contain IC ID: 8017A-MDBT53”.

10. Notes and Cautions

Module is not designed to last for a lifetime. Like general products, it is expected to be worn out after continuous usage through the years. To assure that product will perform better and last longer, please make sure you:

- Follow the guidelines of this document while designing circuit/end-product. Any discrepancy of core Bluetooth technology and technical specification of IC should refer to definition of Bluetooth Organization and Nordic Semiconductor as final reference.
- Do not supply voltage that is not within range of specification.
- Eliminate static electricity at any cost when working with the module as it may cause damage. It is highly recommended adding anti-ESD components to circuit design to prevent damage from real-life ESD events. Anti-ESD methods can be also applied in mechanical design.
- Do not expose modules under direct sunlight for long duration. Modules should be kept away from humid and salty air conditions, and any corrosive gasses or substances. Store it within -40°C to $+125^{\circ}\text{C}$ before and after installation.
- Avoid any physical shock, intense stress to the module or its surface.
- Do not wash the module. No-Clean Paste is used in production. Washing it will oxidize the metal shield and have chemistry reaction with No-Clean Paste. Functions of the module are not guaranteed if it has been washed.

The module is not suitable for life support device or system and not allowed to be used in destructive device or systems in any direct or indirect ways. The customer agrees to indemnify Raytac for any losses when applying modules in applications such as the ones described above.

11. Useful Links

- **Nordic Infocenter:** <https://infocenter.nordicsemi.com/index.jsp>
All the necessary technical files and software development kits of Nordic's chip are on this website.
- **Nordic DevZone:** <https://devzone.nordicsemi.com/questions/>
A highly recommended website for firmware developer. Interact, discuss and consult with other fellow developers and Nordic's employees to get answers to your questions. The site also includes tutorials in detail to help you get started.
- **Official Page of nRF5340 :** <https://www.nordicsemi.com/Products/nRF5340>
A brief introduction to nRF5340 and download links for Nordic's developing software and SoftDevices.

Full List of Raytac's BLE Modules

● MDBT40 Series

Series	Nordic Solution	Raytac No.	IC Ver.	Antenna	RAM	Flash Memory
MDBT40	nRF51822	MDBT40-256V3	3	Chip Antenna	16 kb	256 K
		MDBT40-256RV3			32 kb	256 K
MDBT40-P	nRF51822	MDBT40-P256V3	3	PCB Antenna	16 kb	256 K
		MDBT40-P256RV3			32 kb	256 K

● MDBT42Q Series (QFN Package IC)

Series	Nordic Solution	Raytac No.	IC Ver.	Antenna	RAM	Flash Memory
MDBT42Q	nRF52832	MDBT42Q-512KV2	2	Chip Antenna	64 kb	512 K
	nRF52810	MDBT42Q-192KV2	2		24 kb	192 K
	nRF52811	MDBT42Q-192KL	1			
MDBT42Q-P	nRF52832	MDBT42Q-P512KV2	2	PCB Antenna	64 kb	512 K
	nRF52810	MDBT42Q-P192KV2	2		24 kb	192 K
	nRF52811	MDBT42Q-P192KL	1			
MDBT42Q-U	nRF52832	MDBT42Q-U512KV2	2	u.FL Connector	64 kb	512 K

● MDBT42 Series (WLCSP Package IC)

Series	Nordic Solution	Raytac No.	IC Ver.	Antenna	RAM	Flash Memory
MDBT42	nRF52832	MDBT42-512KV2	2	Chip Antenna	64 kb	512 K
MDBT42-P		MDBT42-P512KV2		PCB Antenna		

● MDBT42V Series (WLCSP Package IC)

Series	Nordic Solution	Raytac No.	IC Ver.	Antenna	RAM	Flash Memory
MDBT42V	nRF52832	MDBT42V-512KV2	2	Chip Antenna	64 kb	512 K
MDBT42V-P		MDBT42V-P512KV2		PCB Antenna		

● MDBT42T Series (WLCSP Package IC)

Series	Nordic Solution	Raytac No.	IC Ver.	Antenna	RAM	Flash Memory
MDBT42T	nRF52805	MDBT42T-192K	1	Chip Antenna	24 kb	192 K
MDBT42T-P		MDBT42T-P192K		PCB Antenna		

● MDBT42TV Series (WLCSP Package IC)

Series	Nordic Solution	Raytac No.	IC Ver.	Antenna	RAM	Flash Memory
MDBT42TV	nRF52805	MDBT42TV-192K	1	Chip Antenna	24 kb	192 K
MDBT42TV-P		MDBT42TV-P192K		PCB Antenna		

● MDBT50Q Series (aQFN Package IC)

Series	Nordic Solution	Raytac No.	IC Ver.	Antenna	RAM	Flash Memory
MDBT50Q	nRF52840	MDBT50Q-1MV2	2	Chip Antenna	256 kb	1 MB
	nRF52833	MDBT50Q-512K	1		128 kb	512 kb
MDBT50Q-P	nRF52840	MDBT50Q-P1MV2	2	PCB Antenna	256 kb	1 MB
	nRF52833	MDBT50Q-P512K	1		128 kb	512 kb
MDBT50Q-U	nRF52840	MDBT50Q-U1MV2	2	u.FL Connector	256 kb	1 MB
	nRF52833	MDBT50Q-U512K	1		128 kb	512 kb
Dongle	nRF52840	MDBT50Q-RX	1, 2	PCB Antenna	256 kb	1 MB

● MDBT50 Series (QFN Package IC)

Series	Nordic Solution	Raytac No.	IC Ver.	Antenna	RAM	Flash Memory
MDBT50	nRF52820	MDBT50-256R	1	Chip Antenna	32 kb	256 kb
	nRF52833	MDBT50-512K	1		128 kb	512 kb
MDBT50-P	nRF52820	MDBT50-P256R	1	PCB Antenna	32 kb	256 kb
	nRF52833	MDBT50-P512K	1		128 kb	512 kb

● MDBT53 Series (WLCSP Package IC)

Series	Nordic Solution	Raytac No.	IC Ver.	Antenna	RAM	Flash Memory
MDBT53	nRF5340	MDBT53-1M	1	Chip Antenna	512 kb	1 MB
MDBT53-P	nRF5340	MDBT53-P1M	1	PCB Antenna	512 kb	1 MB
MDBT53-U	nRF5340	MDBT53-U1M	1	u.FL Connector	512 kb	1 MB

● MDBT53V Series (WLCSP Package IC)

Series	Nordic Solution	Raytac No.	IC Ver.	Antenna	RAM	Flash Memory
MDBT53V	nRF5340	MDBT53V-1M	1	Chip Antenna	512 kb	1 MB
MDBT53V-P	nRF5340	MDBT53V-P1M	1	PCB Antenna	512 kb	1 MB

Release Note

- 2021/02/14 Version A: 1st release.
- 2021/02/23 Version B:
 - (1) Added SRRC certificate in Chapter 9: Certification.
- 2022/07/01 Version C:
 - (1) Updated module photo in Chapter 4: Shipment Packaging Info.
 - (2) Updated image on metal shield in Chapter 4.1
 - (3) Updated Chapter 4: 4.2.1 Tray Packaging.
 - (4) Updated List of Raytac's Model no.
 - (5) Updated Chapter 5: Specification corresponding to Nordic's new nRF5340 Objective Production Specification v1.2.
- 2023/03/15 Version D:
 - (1) Added packaging info and order code in Chapter 4.
 - (2) Updated Chapter 5: Specification corresponding to Nordic's new nRF5340 Objective Production Specification v1.3.