

High Temp Card Edge Connectors 0.156" (3.96mm) Pitch

Features:

- 0.156" (3.96mm) contact spacing x 0.200" (5.08mm) row spacing
- Accepts 0.062" (1.57mm) nominal thickness P.C. board
- High profile insulator body, 0.600" (15.24mm)
- Card slot depth of 0.388" (9.86mm)
- Contact termination options include P.C. tail, wire hole, wire wrap, 90 degree and extender board bends
- Single or dual row configurations
- Large variety of mounting options, flush or offset lugs
- Accepts between contact and in-contact polarizing keys
- RoHS Compliant

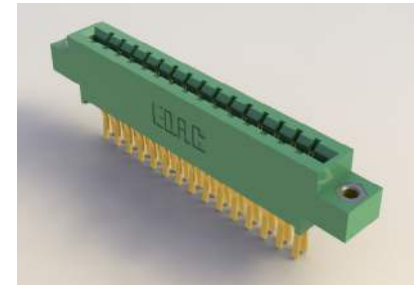

Specifications:

Insulator Material	Diallyl Phthalate, UL 94V-0, Green Color
Contact Material	Copper Alloy
Contact Plating	Gold Plating on mating area and Tin Plating on tails with Nickel underplating all over
Current Rating	3 amps
Contact Resistance	10 milliohms maximum
Dielectric Withstanding Voltage	1800 V AC rms at sea level between adjacent contacts
Insulation Resistance	5000 megaohms minimum
Operating Temperature	-40°C to +125°C
Insertion Force	16 oz (4.45 N) maximum per contact pair when tested with .070" (1.78mm) thick gauge
Withdrawal Force	1 oz (0.28 N) minimum per contact pair when tested with .054" (1.37mm) thick gauge

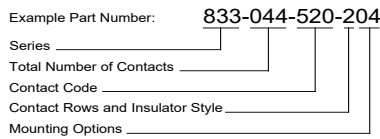

Series:

833

Total Number of Contacts: Contact Rows:

006, 007, 043 Single Row
012, 014, 086 Dual Row

Contact Code:	Description:	Tail Size:	Tail Length "G":
500	Wire Hole	.050 x .025 (1.27 x 0.64)	.260 (6.60)
520	P.C. Tail	.030 x .018 (0.76 x 0.46)	.175 (4.45)
521	P.C. Tail	.025 Square (0.64 Square)	.150 (3.81)
523	P.C. Tail	.025 Square (0.64 Square)	.390 (9.91)
524	P.C. Tail	.018 Square (0.46 Square)	.175 (4.45)
540	Wire Wrap	.025 Square (0.64 Square)	.560 (14.22)
541	Wire Wrap	.025 Square (0.64 Square)	.750 (19.05)
542	Wire Wrap	.025 Square (0.64 Square)	.645 (16.38)
544	Wire Wrap	.050 x .025 (1.27 x 0.64)	.750 (19.05)
555	EXTENDER BOARD BEND	(Code 500 Contacts)	
556	EXTENDER BOARD BEND	(Code 520 Contacts)	
558	90 DEGREE BEND	(Code 541 Contacts)	
559	90 DEGREE BEND	(Code 541 Contacts)	
560	EXTENDER BOARD BEND	(Code 523 Contacts)	

Contact Rows:	Insulator Style:	Description:
1	Flush Mounting Lugs	Single Row
2	Flush Mounting Lugs	Dual Row
6	.170 (4.32) Offset Lugs	Single Row
8	.170 (4.32) Offset Lugs	Dual Row

Mounting Options:

01	No Mounting Lug
02	Ø.128" (Ø3.25mm) Mounting Holes
03	Ø.116" (Ø2.95mm) I.D. Floating Eyelets
04	Ø.156" (Ø3.96mm) Mounting Holes
07	M3-0.5 Metric Threaded Inserts
08	#4-40 Unified Threaded Inserts
12	Ø.128" (Ø3.25mm) Side Mounting Holes

Ordering Code Notes:

- 1) All connector sizes up to 43 contacts single row / 86 contacts dual row are available upon request.
- 2) For details of the extender board and 90 degree bends refer to next pages.
- 3) For lugless connectors, code 01 mounting, specify contact row code 1 or 2.
- 4) For details of the mounting options refer to next pages.

High Temp Card Edge Connectors 0.156" (3.96mm) Pitch

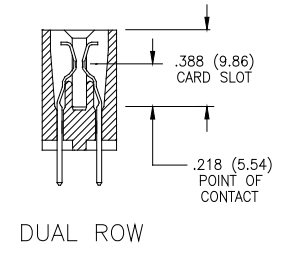
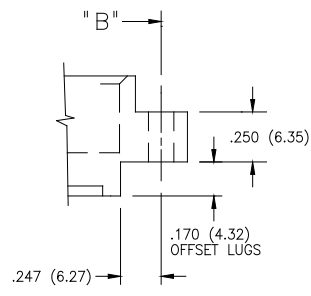
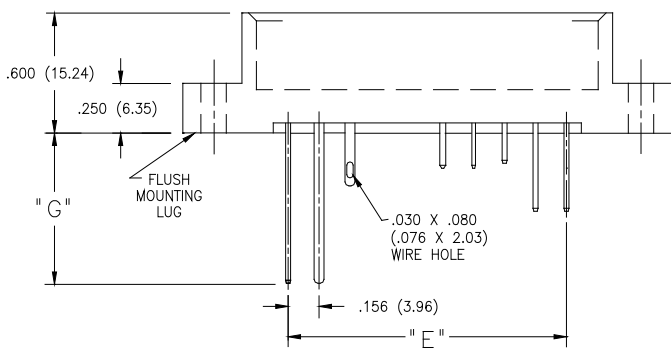
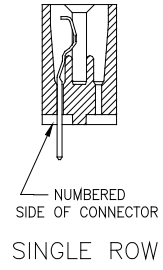
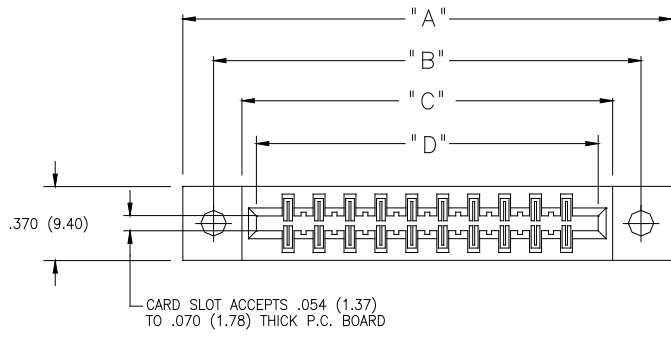

IN-CONTACT POLARIZING KEY
P/N 345-240-328

BETWEEN CONTACT POLARIZING KEY
P/N 306-240-318

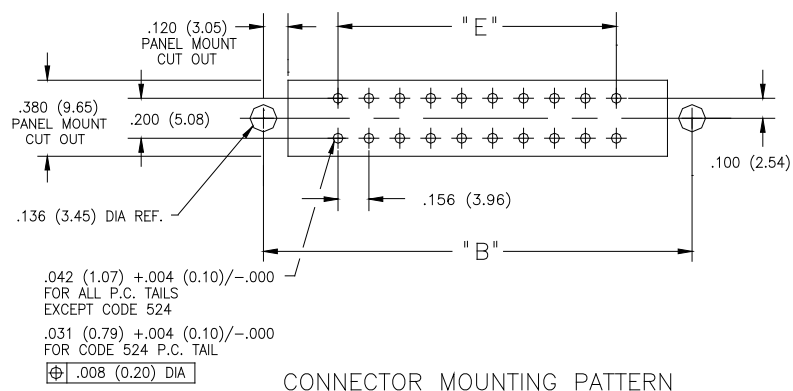
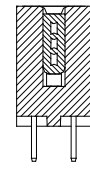
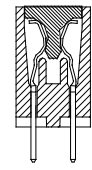
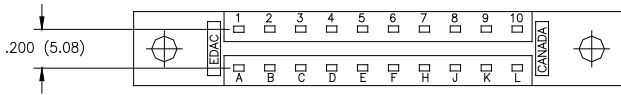

CONNECTOR MOUNTING PATTERN

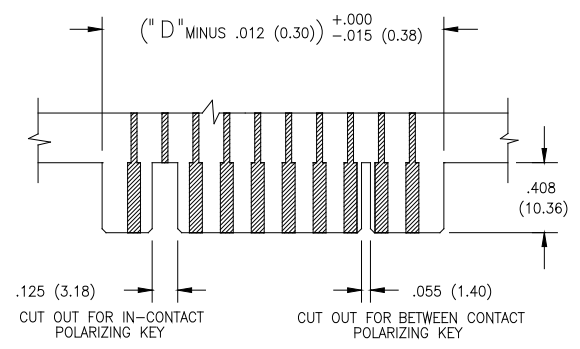

RECOMMENDED DAUGHTER BOARD

NUMBER OF CONTACTS		"A"		"B"		"C"		"D"		"E"	
Single	Double	Inch	mm	Inch	mm	Inch	mm	Inch	mm	Inch	mm
6	12	1.784	45.31	1.534	38.96	1.261	32.03	1.100	27.94	0.780	19.81
10	20	2.408	61.16	2.158	54.81	1.885	47.88	1.724	43.79	1.404	35.66
15	30	3.148	79.96	2.898	73.61	2.625	66.68	2.464	62.59	2.144	54.46
18	36	3.656	92.86	3.406	86.51	3.133	79.58	2.972	75.49	2.652	67.36
22	44	4.280	108.71	4.030	102.36	3.757	95.43	3.596	91.34	3.276	83.21
28	56	5.216	132.49	4.966	126.14	4.693	119.20	4.532	115.11	4.212	106.98
36	72	6.464	164.19	6.214	157.84	5.941	150.90	5.780	146.81	5.460	138.68
37	74	6.620	168.15	6.370	161.80	6.097	154.86	5.936	150.77	5.616	142.65
43	86	7.556	191.92	7.306	185.57	7.033	178.64	6.872	174.55	6.552	166.42

